

CA
TÁ
LO
GO

22

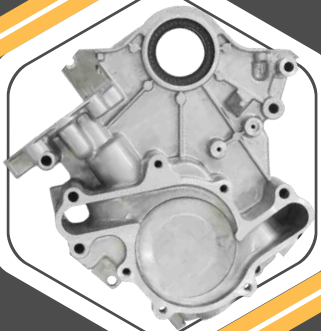

QUEZADA
FABRICANTE DE PARTES
AUTOMOTRICES

PRESENTACIÓN

Compañía Industrial Quezada S.A. de C.V. es una empresa 100% mexicana enfocada a la manufactura, comercialización y distribución de refacciones y accesorios automotrices. Cuenta con más de 57 años de experiencia en el área comercial y 50 años en la fabricación y maquila de productos de Aluminio inyectado y vaciado, Tubo, Metal vulcanizado y Zamak.

Compañía Industrial Quezada S.A. de C.V. cuenta con la calidad de equipo Original en todos sus productos y precios competitivos en el mercado de repuesto.



compañía industrial
QUEZADA
s.a de c.v



"Inyección de Aluminio Zamack y Plásticos"

Nuestros productos y servicios:

- Desarrollo de productos en tubo y hule
- Desarrollo de productos inyectados a presión en Aluminio y Zamak (Die-Casting)
- Diseño y fabricación de moldes
- Fundición de Aluminio: Vaciado de arena por gravedad
- Inyección de Plástico
- Partes de Dirección
- Partes de Motor
- Partes de Sistema de enfriamiento
- Partes de Tracción
- Partes Diesel

Nuestra experiencia, servicio y calidad como empresa nos ha permitido ofrecer productos líderes en el Mercado Mexicano y exportar productos en las principales zonas de America (Norte, Centro y sur), Medio Oriente y Norte de Europa.



En Compañía Industrial Quezada tenemos como misión ayudar a nuestros clientes a obtener mejores oportunidades de negocio ofreciendo productos y servicios de la mejor calidad a precios competitivos que permitan el desarrollo continuo de nuestras organizaciones.



La numeración de la mayoría de nuestras líneas se basa en series de calificación internacional por armadora para identificarlas rápida y eficazmente.

- | | |
|-------------|------------------------|
| SERIE 4000 | AUTOS EUROPEOS |
| SERIE 5000 | CHRYSLER |
| SERIE 6000 | GENERAL MOTORS |
| SERIE 7000 | FORD |
| SERIE 8000 | AMC |
| SERIE 9000 | AUTOS ASIATICOS |
| SERIE 1-999 | AUDI/ SEAT/ VOLKSWAGEN |



BALERO PILOTO DE CLUTCH

14



COLUMNA DE DIRECCIÓN

15



BASE DE BOMBA DE AGUA

16



BASES DE CARBURADOR

18



**DEPÓSITOS: ANTICONGELANTES, LIMPIA PARABRISAS,
DE DIRECCIÓN Y TAPONES**

25

AUDI/ BMW..... 26

CHRYSLER 27

FIAT 30

FORD 30

GIANT MOTORS (FAW)/ GENERAL MOTORS 39

HONDA 47

HUMMER / HYUNDAI 48

ISUZU/ JAGUAR/ KIA/ MAZDA..... 49

MERCEDEZ BENZ/ MITSUBISHI 50

NISSAN 51

RENAULT/SUBARU/ SUZUKI/ TOYOTA 54

UNIVERSAL, VOLKSWAGEN 56

EQUIPO PESADO

FREIGHTLINER 61

GMC/ HINO 62

IC CORPORATION/ INTERNATIONAL 63

ISUZU 64

KENWORTH/ MACK 65

MERCEDEZ BENZ/ PETERBILT / STERLING TRUCK 66

VOLVO 67

**MOTORES DE DEPÓSITO DE LIMPIAPARABRISAS /
MOTOR DEL BRAZO LIMPIADOR DE PARABRISAS**

NISSAN /VOLKSWAGEN 68

HYUNDAI/ VOLKSWAGEN 69





DIRECCIÓN: CAMPANAS DE LA COLUMNA DE DIRECCIÓN

FORD/CHRYSLER 70



DIRECCIÓN: FLAUTAS

71



DIESEL Y GASOLINA

BIELAS 72

PARTES DIESEL..... 73

SEPARADORES DE VENTILADOR..... 74



TAPAS

DEFLECTORES / CARTER 75

TAPAS DE PUNTERÍA 77

SOPORTE DE ÁRBOL DE LEVAS/ ÁRBOL DE LEVAS 78



TAPAS DE DISTRIBUCIÓN

CHRYSLER / FORD 79

GENERAL MOTORS 81

NISSAN 82

TOYOTA / VOLKSWAGEN 84



TOMAS DE AGUA

87

ACURA/ AUDI..... 86

BMW 87

CHRYSLER 90

FIAT 96

FORD (SENSORES Y TERMOSTATOS)..... 97

GENERAL MOTORS 118

HONDA 135

HYUNDAI 136

ISUZU Y SUBARU /MAZDA 139

MITSUBISHI/ NISSAN 141

PEUGEOT 148



RENAULT/ TOYOTA	149
VAM=AMC.....	153
VOLKSWAGEN	154

TRACCIÓN:

ESPIGAS & JUNTAS HOMOCINÉTICAS	170
--------------------------------	------------

MACHETAS	185
----------	------------

DIRECCIÓN	186
-----------------	-----

TRACCIÓN	190
----------------	-----

REPUESTO DE TRÍPODE	202
---------------------	------------

KIT DE REPUESTO DE TRÍPODE CON MACHETA	203
--	------------

TRÍPODE	204
---------	------------

TRÍPODE CON MACHETA	213
---------------------	------------

TUBOS DE ENFRIAMIENTO	218
------------------------------	------------

CHRYSLER	219
----------------	-----

FIAT/ FORD	220
------------------	-----

GENERAL MOTORS	223
----------------------	-----

HONDA/ HYUNDAI	227
----------------------	-----

MAZDA/ NISSAN	228
---------------------	-----

RENAULT / TOYOTA/ VOLKSWAGEN	232
------------------------------------	-----

VÁLVULAS

FORD/ GENERAL MOTORS.....	237
---------------------------	-----

VOLKSWAGEN.....	238
-----------------	-----



VARIOS: *SOPORTES, CAMPANAS, MARIPOSAS, RETENES, PEDLAES*

239



MAQUILA Y ACCESORIOS: *GRADUADOR DE BUJIAS, LLAVEROS, MARCOS PORTAPLACA, EMBUDOS,*

242



RECOMENDACIONES Y GARANTIAS

248



ACURA

TOMAS DE AGUA	92, 136
TRACCIÓN: JUNTAS HOMOCINÉTICAS	186
TRÍPODES	210
TRÍPODES CON MACHETA	216

AUDI

BALERO PILOTO DE CLUTCH	14
DEPÓSITOS (TAPÓNES)	26, 58
TOMAS DE AGUA	90, 91, 161-167
TRACCIÓN: JUNTAS HOMOCINÉTICAS	178, 180, 181, 186
TRACCIÓN: TRÍPODES	210, 211
TRACCIÓN: TRÍPODE CON MACHETA	216
TUBOS Y MANGUERAS	234

BMW

DEPÓSITOS	26
TOMAS DE AGUA	89

CHRYSLER

BALERO PILOTO DE CLUTCH	14
COLUMNA DE DIRECCIÓN	15
BASES DE BOMBA DE AGUA	16
BASES DE CARBURADOR	19
DEPÓSITOS (TAPÓNES)	27
DIRECCIÓN: CAMPANA DE LA COLUMNA	71
PARTES DIESEL	75, 76
TAPAS: TAPAS DE DISTRIBUCIÓN	81
TOMAS DE AGUA	92
TRACCIÓN: JUNTAS HOMOCINÉTICAS	173-185
TRACCIÓN: MACHETAS	188, 193
TRACCIÓN: REPUESTOS DE TRÍPODE	204
TRACCIÓN: TRÍPODES	207-211
TRACCIÓN: TRÍPODE CON MACHETA	213-217
TUBOS Y MANGUERAS	219
VARIOS: <i>PORTA RETÉN</i>	239

DINA

PARTES DIESEL / BIELAS	74
PARTES DIESEL Y GASOLINA	75



FIAT

DEPÓSITOS (<i>TAPÓNES</i>)	31
TOMAS DE AGUA	99
TUBOS Y MANGUERAS	220

FORD

BALERO PILOTO DE CLUTCH	14
COLUMNA DE DIRECCIÓN	15
BASES DE BOMBA DE AGUA	16
BASES DE CARBURADOR	18, 19, 21
DEPÓSITOS (<i>TAPÓNES</i>)	31
DIRECCIÓN: CAMPANA DE LA COLUMNA	71
DIRECCIÓN: FLAUTAS	72
TAPAS: TAPAS DE DISTRIBUCIÓN	81
TOMAS DE AGUA	99
TOMAS DE AGUA: <i>SENSORES Y TERMOSTATOS</i>	119
TRACCIÓN: JUNTAS HOMOCINÉTICAS	173, 176-179, 182, 184, 186
TRACCIÓN: MACHETAS	189, 194
REPUESTO DE TRÍPODE	204
TRACCIÓN: TRÍPODES	206-212
TRACCIÓN: TRÍPODE CON MACHETA	213-217
TUBOS Y MANGUERAS	220
VÁLVULAS	238

FREIGHTLINER

DEPÓSITOS	62
-----------------	----

GENERAL MOTORS

BALERO PILOTO DE CLUTCH	14
COLUMNA DE DIRECCIÓN	15
BASES DE CARBURADOR	18, 19, 21, 23
DEPÓSITOS (<i>TAPÓNES</i>)	40
MOTORES DE DEPÓSITO DE LIMPIAPARABRISAS / DEL BRAZO LIMPIADOR DE PARABRISAS	70
TAPAS: TAPAS DE PUNTERÍA	78
CAJA Y ÁRBOL DE LEVAS	80
TAPAS: TAPAS DE DISTRIBUCIÓN	83
TOMAS DE AGUA	120
TRACCIÓN: JUNTAS HOMOCINÉTICAS	173-178 182-185
TRACCIÓN: MACHETAS	188
REPUESTO DE TRÍPODE	204
TRACCIÓN: TRÍPODES	206,
TRACCIÓN: TRÍPODE CON MACHETA	213-217



ÍNDICE

TUBOS Y MANGUERAS	223
VÁLVULAS	238
VARIOS: <i>SOPORTE DE MOTOR</i>	239
GMC	
<hr/>	
PARTES DIESEL	77
DEPÓSITOS (<i>TAPÓNES</i>)	44
DEPÓSITOS: EQUIPO PESADO	63
TOMAS DE AGUA	122-132, 156
TRACCIÓN: JUNTAS HOMOCINÉTICAS	174
HINO	
<hr/>	
DEPÓSITOS	63
HONDA	
<hr/>	
DEPÓSITOS (<i>TAPÓNES</i>)	48
TOMAS DE AGUA	137
TRACCIÓN: JUNTAS HOMOCINÉTICAS	179, 180, 186
TRACCIÓN: MACHETAS	188,196
TRÍPODES	207, 210
TRÍPODE CON MACHETA	213, 214, 216
TUBOS Y MANGUERAS	227
HUMMER	
<hr/>	
DEPÓSITOS : TAPÓN RADIADOR	49
TOMAS DE AGUA	128,132,133
HYUNDAI	
<hr/>	
DEPÓSITOS (<i>TAPÓNES</i>)	50
MOTORES DE DEPÓSITO DE LIMPIAPARABRISAS / DEL BRAZO LIMPIADOR DE PARABRISAS.....	70
TOMAS DE AGUA	138
TRACCIÓN: JUNTAS HOMOCINÉTICAS	181,182
TRACCIÓN: TRÍPODES	206, 207
TRACCIÓN: TRÍPODE CON MACHETA	213
TUBOS Y MANGUERAS	228
IC CORPORATION	
<hr/>	
DEPÓSITOS EQUIPO PESADO	64
INTERNATIONAL	
<hr/>	
DEPÓSITOS	64



ISUZU Y SUBARU

DEPÓSITOS (TAPÓNES)	45, 51, 57
DEPÓSITOS: EQUIPO PESADO	65
TOMAS DE AGUA	126, 127,
	129-131, 141
TRACCIÓN: JUNTAS HOMOCINÉTICAS	189
REPUESTOS DE TRÍPODE	204
TRACCIÓN: TRÍPODES	206
TRÍPODE CON MACHETA	213

JAGUAR

DEPÓSITOS (TAPÓNES)	50
---------------------------	----

KENWORTH

DEPÓSITOS: EQUIPO PESADO	66
--------------------------------	----

KIA

DEPÓSITOS (TAPÓNES)	50
---------------------------	----

MACK

DEPÓSITOS	66
-----------------	----

MAZDA

DEPÓSITOS (TAPÓNES)	39, 52
TOMAS DE AGUA	99, 141
TRACCIÓN: JUNTAS HOMOCINÉTICAS	184
REPUESTOS DE TRÍPODE	205
TRACCIÓN: TRÍPODES	207, 208, 211
TRACCIÓN: TRÍPODE CON MACHETA	213, 216, 217
TUBOS Y MANGUERAS	228

MERCEDES BENZ

DEPÓSITOS: TAPÓN RADIADOR	52, 67
---------------------------------	--------

MITSUBISHI

BASE DE BOMBA DE AGUA	16
DEPÓSITOS (TAPÓNES)	53
TOMAS DE AGUA	96, 142
TRACCIÓN: JUNTAS HOMOCINÉTICAS	181



ÍNDICE

NISSAN

BASES DE BOMBA DE AGUA	17
BASES DE CARBURADOR	19,20, 24, 25
DEPÓSITOS	53
MOTORES DE DEPÓSITO DE LIMPIAPARABRISAS / DEL BRAZO LIMPIADOR DE PARABRISAS	69, 70
TAPAS: TAPAS DE PUNTERÍA	79
TAPAS: TAPAS DE DISTRIBUCIÓN	88
TOMAS DE AGUA	143
TRACCIÓN: JUNTAS HOMOCINÉTICAS	174-177, 179,182,183
TRACCIÓN: MACHETAS	188,197
TRACCIÓN: REPUESTOS DE TRÍPODE	204, 205
TRACCIÓN: TRÍPODES	207-211
TRACCIÓN: TRÍPODE CON MACHETA	214-216
TUBOS Y MANGUERAS	228
VARIOS: CANDELEROS DE TRANSMISIÓN	239

PETERBILT

DEPÓSITOS: EQUIPO PESADO	67
--------------------------------	----

PEUGEOT

TOMAS DE AGUA	150
TRACCIÓN: JUNTAS HOMOCINÉTICAS	182,183
TRACCIÓN: MACHETAS	189, 198
TRACCIÓN: TRÍPODES	206, 207
TRACCIÓN: TRÍPODE CON MACHETA	216

RENAULT

BASE DE CARBURADOR	20, 22-24
DEPÓSITOS	55
TOMAS DE AGUA	151
TRACCIÓN: JUNTAS HOMOCINÉTICAS	177
TRACCIÓN: MACHETAS	188,199
TRACCIÓN: TRÍPODES	206, 207
TRACCIÓN: TRÍPODE CON MACHETA	214
TUBOS Y MANGUERAS	232

STERLING TRUCK

DEPÓSITOS	67
-----------------	----

TOYOTA

DEPÓSITOS	56
-----------------	----



TAPAS: TAPAS DE DISTRIBUCIÓN	86
TOMAS DE AGUA	152
TRACCIÓN: JUNTAS HOMOCINÉTICAS	173, 180
TRACCIÓN: MACHETAS	189, 200
TRACCIÓN: REPUESTOS DE TRÍPODE	205
TRACCIÓN: TRÍPODES	207, 208, 211, 212
TRACCIÓN: TRÍPODE CON MACHETA	213-216
TUBOS Y MANGUERAS	232

VAM=AMC

TOMAS DE AGUA	155
---------------------	-----

VOLKSWAGEN

BALERO PILOTO DE CLUTCH	14
BASES DE CARBURADOR	18, 19, 22, 23
DEPÓSITOS	59
MOTORES DE DEPÓSITO DE LIMPIAPARABRISAS / DEL BRAZO LIMPIADOR DE PARABRISAS	69, 70
TAPAS: DEFLECTORES / CARTER	77
TAPAS: TAPAS DE DISTRIBUCIÓN	86
TOMAS DE AGUA	156
TRACCIÓN: JUNTAS HOMOCINÉTICAS	174, 176, 178-181, 184-186
TRACCIÓN: MACHETAS	190, 200
TRACCIÓN: TRÍPODES	209-211
TRACCIÓN: TRÍPODE CON MACHETA	215-217
TUBOS Y MANGUERAS	218, 219
VÁLVULAS	232
VARIOS: <i>MARIPOSA CHICOTE DE CLUTCH, SOPORTE DE MOTOR, CAMPANA DE CAJA DE VEL., RETÉN DE CAMPANA</i>	239, 240

VOLVO

DEPÓSITOS	68
TRACCIÓN: TRÍPODES	208
TRACCIÓN: TRÍPODE CON MACHETA	215



BALEROS

PILOTO DE CLUTCH

BALEROS

CHRYSLER



BC-5129

Ref.: BC-129

DODGE MICROBUS
RAM-CHARGER/
MAQ. 360, 8 CIL y 6 CIL

91/UP

No. Original: 53009180
Ref.: 750A



BC-5699

Ref.: BC-699

DAKOTA 2.5L, 3.9L, 4 y 6 CIL
USA

96/01

No. Original: 69906
Ref.: 750E

FORD



BC-7313-C

Ref.: 313-C

AUDI A3, A4, CHEVROLET ASTRA,
CORSA LUV, VECTRA, ZAFIRA, FORD
CONTOUR, ESCORT, MONDEO,
RANGER, MERCURY, MYSTIQUE
MAQ. 2.3L y 2.0L

92/UP

No. Original: D4ZA-712, AB/410000900
Ref.: 750C



BC-7476

Ref.: BC-476

FORD AUTO y CAMIÓN
F-100 F-250 F-350 B-600
F-600
MAQUINA 302-351-335

68/UP

No. Original: D4DZ-7600-A
Ref.: 750



BC-7500

Ref.: BC-500

FORD CAMIONETAS V-10 F-350,
F-450 Y F-550 SUPER DUTTY
TRANS. TREMEC O FORD SPICER
NACIONAL y AMERICANA
MAQ. 5.7 y 7.5 L

00/08

No. Original: F65A-7120-AA Ref.: 750F



BC-7600

Ref.: BC-600

SUPER DUTTY 5.7 L
CAMIONETAS 7.3 y 7.5, V-8 y V-10.
F-350, F-450 y F-550. TRANS. TREMEC
o FORD SPICER

92/08

No. Original: F3TA-7120-AA
E3TZ-7600-B, D8TZ-7600-A
Ref.: 750G

GM



BC-6512

Ref.: BC-1512

CHEVROLET 6 CIL
MAQ 292 y V8 MAQ 350.
CAMIONETA LUV L4
2.2L y 2.3L, 5 VEL. (MPFI)

68/01

No. Original: 14061685

Ref.: 750B

VW



BC-1532

Ref.: VW-1532

BEETLE 1.8 y 2.0 GOLF, JETTA,
POINTER 1.8L
COMBI T2 y T2A 1.8L
CORSAR T3 1.8L

98/02

88/UP

84/89

No. Original: 026-105-313
Ref.: 750D



**CHRYSLER
Y FORD**



FB-7491

Ref.: 5491

HULE FUNDA PARA BALERO

CHRYSLER 6 y 8 CIL. (AUTOS)	63/82
CHRYSLER AUTOS y PICK-UP 6 y 8 CIL	70/94
CAMIONETAS	63/UP
FORD GALAXIE y F-100.	67/77
FORD AUTOS y PICK-UP	71/79
FORD CAMIONES F-600 y B-600	74/84
TOPAZ y GHIA	84/94

**CHRYSLER
Y FORD**



BD-7228

Ref.: P-10228

PORTA BALERO Y HULE FUNDA

FORD AUTOS y PICK-UP	71/79
FORD CAMIONES F-600 y B-600	74/84
TOPAZ y GHIA	84/94
CHRYSLER AUTOS y PICK-UP 6 y 8 CIL	70/94

■ **APLICA TAMBIÉN PARA CHRYSLER**



BD-7351

EXPLORER, F-250, F-350, F-450, F-550, FREESTAR, LINCOLN, ESCAPE MUSTANG 6.0L, 6 CIL WINDSTAR (30 a 19mm INFERIOR PEQUEÑO)	01/07 96/03
---	----------------------------

No. Original: F4DZ-3517-A



BD-7435

EXPLORER, F-250, F-350, F-450, F-550, FREESTAR, LINCOLN, ESCAPE MUSTANG 6.0L, 6 CIL WINDSTAR (51 a 40mm SUPERIOR GRANDE)	01/07 96/03
--	----------------------------

No. Original: F4DZ-3517-C

GM



BD-6465-1

BALERO Y PISTA

SUBURBAN, SILVERADO, CHEYENNE, SONORA, PICK UP TODAS 8 y 6 CIL.	87/98
---	-------

No. Original: 7844651



BASES DE BOMBA DE AGUA

CHRYSLER/ FORD

BASES DE BOMBA DE AGUA

CHRYSLER

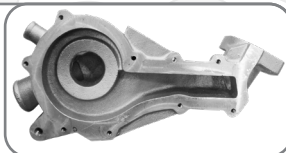
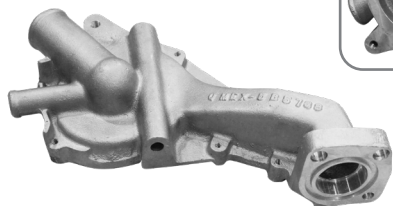

5B5738

SPIRIT, SHADOW 2.2 y 2.5L, 4 CIL

91/95

No. Original: 4315738

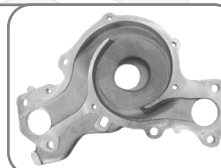

5B7394

CARAVAN, TOWN & COUNTRY SPIRIT
VOYAGER
MITSUBISHI MONTERO SPORT V-6, 3.0L

86/98
96/00
03/06

No. Original: MD973940

FORD

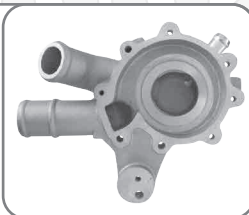
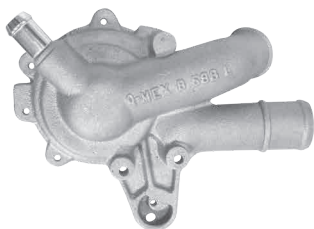

7B588L

ESCAPE 3.0L, 6 CIL
MARINER 3.0L, 6 CIL
CON y SIN BARRENO PARA POLEA TENSORA **PLANA**.

09/UP
01/06

No. Original: 5L8Z-8501-AA

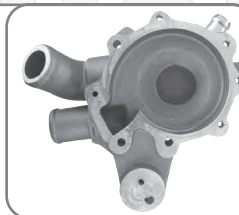
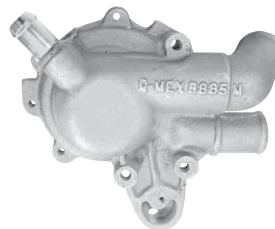

7B885M

FUSION 3L, 6 CIL
CONTOUR - MISTIQUE 6 CIL *CON Y SIN BARRENO*
PARA POLEA TENSORA CON AIRE ACONDICIONADO
MAQ 2.5 6 CIL MONDEO 6 CIL **CÓNICA**

07/12
95/02

No. Original: 5M8Z-8501-B



7B750G

FOCUS 2.0L, 16V, 4 CIL

03/10

No. Original: 978M-8505-CG, 1084796

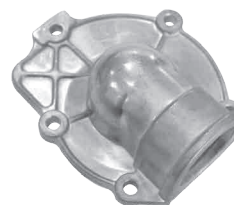

7008

ALOJAMIENTO PARA BOMBA DE AGUA

Ref.: 8508

NACIONAL Y AMERICANA

FORD 4 CIL TOPAZ. MOTOR 140. 2.3L

84/94

No. Original: E53E-8508-AA

APLICA PARA TUBO 78290-A Y 78290-B

BASES DE BOMBA DE AGUA

NISSAN/ VW



NISSAN

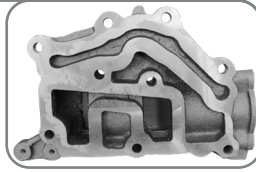
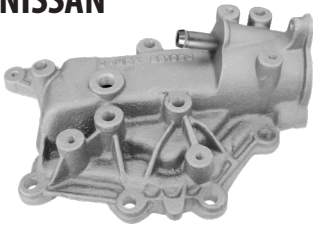

9B106C

PLATINA y CLIO 1.6L, 4 CIL
APRIO 1.6L, 4 CIL

03/UP
08/UP

No. Original: 11061-00Q1C

VOLKSWAGEN

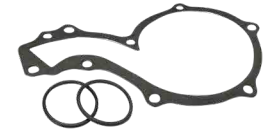

1B371C

POINTER 1.8L, 4 CIL

TODOS

No. Original: 037-121-010-C

BASES DE BOMBA DE AGUA

Compañía Industrial Quezada S. A. de C. V.

San Esteban No. 47-1 Col. San Sebastián, C.P. 02040, Azcapotzalco - Ciudad de México

Tels. (01-55) 5353-0690, 5353-0816, 5353-0774 / www.quezada.com.mx / E-mail: ventas@quezada.com.mx

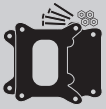

BASES DE CARBURADOR

BASES DE CARBURADOR

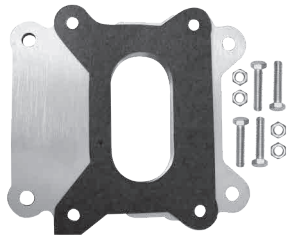

12-10

CONVERSIÓN

CHEVROLET 4 GARGANTAS A FORD
2 GARGANTAS MOTORCRAFT
CON TORNILLOS Y JUNTA

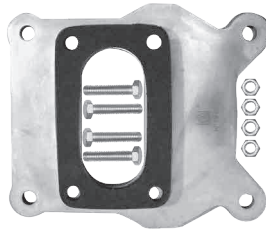

12-32

CONVERSIÓN

ROCHESTER 4 A HOLLEY 2 GARG.
MOTORCRAFT
CON TORNILLOS Y JUNTA

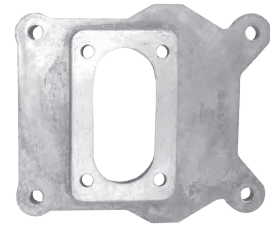

12-32-C

CONVERSIÓN

ROCHESTER 4 A CARTER
2 GARGANTAS MOTORCRAFT
CON TORNILLOS Y JUNTA

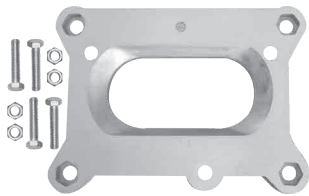

12-40

CONVERSIÓN

CHEVROLET TBI 350
2 GARGANTAS A FORD 2 GARGANTAS
MOTORCRAFT
MICROBUS 92PICK-UP IMPORTADA,
SUBURBAN, BLAZER
CON TORNILLOS Y JUNTA

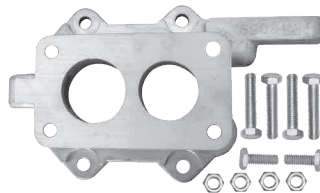

6059

BASE DE CARBURADOR

SERIE K. MOTOR 135 2.2 L y 2.5 L 82/88
SIN TUBO DE VACIO
CON TORNILLOS Y JUNTA

No. Original: 4293755

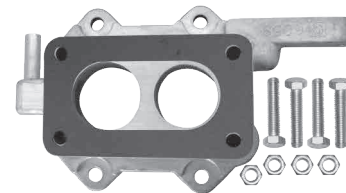

6059-A

BASE DE CARBURADOR

SERIE K, SHADOW
CON TUBO DE VACIO
BIELA DE COMPRESOR

No. Original: 4300988



761-E

BASE DE CARBURADOR

GOLF-JETTA A2, A3,
T2A, CORSART 3
88/99

No. Original: 026-129-761-E



761-F

BRIDA CARBURADOR

A3-DERBY 95/97 MONOTRONIC

No. Original: 050-129-761-F

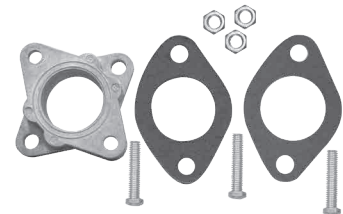

7705

BASE DE CARBURADOR

CARIBE y ATLANTIC A1
MOD. 77/85
CON TORNILLOS Y JUNTA

No. Original: 055-129-761-C

BASES DE CARBURADOR

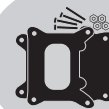

BASES DE CARBURADOR



B-200A

DATSUN 1500/1600

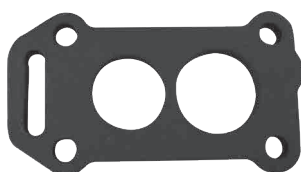

B-202A

TSURU AUTOMATICO

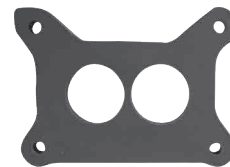

B-203A

FORD MOTORCRAFT 2 G. 5 MM

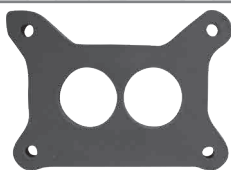

B-204A

FORD
MOTORCRAFT 2 G. 10 MM

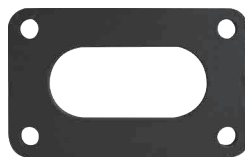

B-205A

CHEV. 8 C. ROCHESTER 2 G.



B-206A

CHEV. 6 C. ROCHESTER 1 G.



B-207A

DODGE 8 C. CARTER
2 GARGANTAS



B-208A

DODGE 8 C. HOLLEY
2 GARGANTAS



B-209A

DODGE 6 C. HOLLEY
1 GARGANTA



B-210A

RAMBLER 6 C. MOTORCRAFT
2 GARGANTAS.



B-211A

RAMBLER 6 C. CARTER (YF)
1 GARGANTA



B-215A

RENAULT R-12 TL. NISSAN 84/86 Y VW



B-213A

FORD 8 C. MOTORCRAFT
4 GARGANTAS



B-216A

R-18 2 LITROS



B-218A

RAMBLER 6 C. 1 GARGANTA
C/VENTILACION



BASES DE CARBURADOR

BASES DE CARBURADOR



B-219A

NISSAN HITACHI

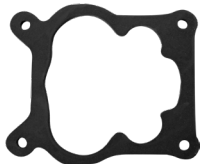

B-220A

CHEV. QUADRAJET



B-221A

BRIDA CARBURADOR BOCAR,
RENAULT R-12 TL y TSURU

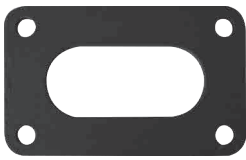

B-222A

BRIDA CARBURADOR RENAULT,
ALLIANCE y ENCORE



B-223A

BRIDA CARBURADOR DODGE DART K



B-224A

PIESBURG (TSURU III)



B-225A

TAPA FILTRO DE AIRE CHEV. 4 G.

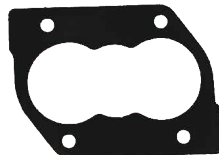

B-227A

HOLLEY TBI



B-228A

MICROBUS CHEV.



B-229A

CHEV. CITATION
(SIN RESISTENCIA)



B-230A

TSURU 93/94



B-232A

ROCHESTER 2 GARGANTAS
MODELO 73/83



B-233A

DUAL JET ROCHESTER

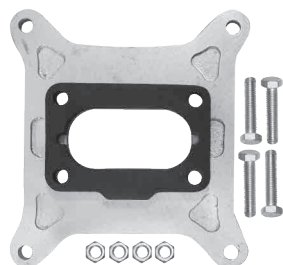
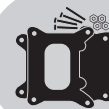

B-304A

ADAPTACIÓN

FORD/DODGE CARTER
4 A 2 GARGANTAS

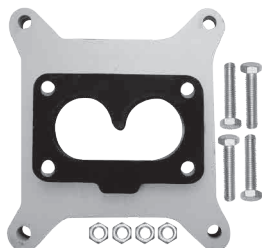

B-305A

ADAPTACIÓN

FORD/CHEV. DODGE HOLLEY 4 2 G.V
1700

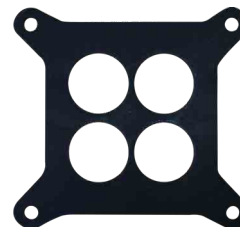

B-306

AUMENTO

FORD 4 GARGANTAS
C/ VENTILACION (DE FIBRA)



B-307A

AUMENTO

FORD 2 GARGANTAS
19MM DE ESPESOR
CON TUBO DE VENTILACIÓN.
CON JUNTA

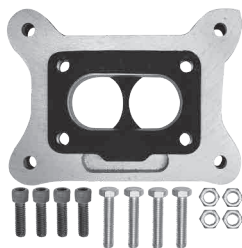

B-310A

ADAPTACIÓN

DODGE CARTER (2) A FORD (2)
CON TORNILLOS Y JUNTA

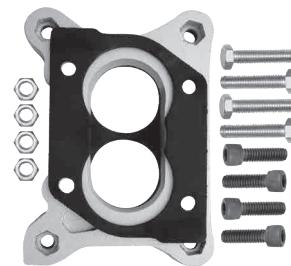

B-311A

ADAPTACIÓN

HOLLEY TBI/ FORD 2 A 2 GARGANTAS
CON TORNILLOS Y JUNTA



B-312A

ADAPTACIÓN

CHEVROLET 4 GARG. a DUALJET 2
GARG.
CON TORNILLOS Y JUNTA



B-314A

ADAPTACIÓN

HOLLEY
TB/HOLLEY 360, 2 a 2 GARGANTAS.
CON TORNILLOS Y JUNTA

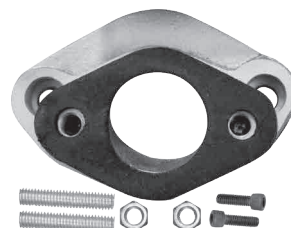

B-315A

ADAPTACIÓN

VW 1500/1600
CON TORNILLOS Y JUNTA

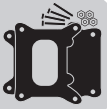

BASES DE CARBURADOR

BASES DE CARBURADOR

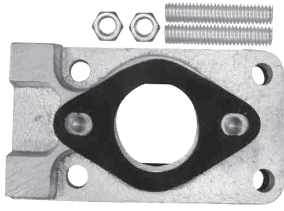

B-316A

ADAPTACIÓN

NISSAN NIKKI, HITACHI/SOLEX
TSURU 2 GARG. A 1 GARGANTA.
CON TORNILLOS Y JUNTA

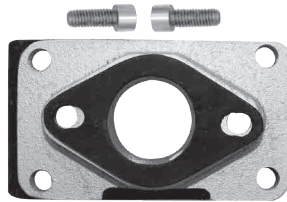

B-317A

ADAPTACIÓN

RENAULT
ALLIANCE/SOLEX VW
2 A 1 GARGANTA
CON TORNILLOS Y JUNTA

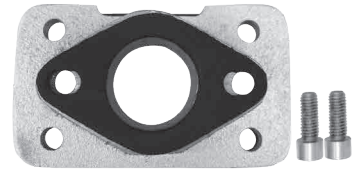

B-318A

ADAPTACIÓN

NISSAN NIKKI SOLEX VW 2 GARG. A
1 GARGANTA
CON TORNILLOS Y JUNTA

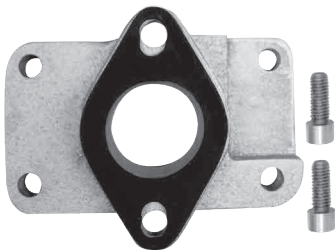

B-319A

ADAPTACIÓN

RENAULT 2LTS./SOLEX VW
2 GARGANTAS A 1 GARGANTA
CON TORNILLOS Y JUNTA

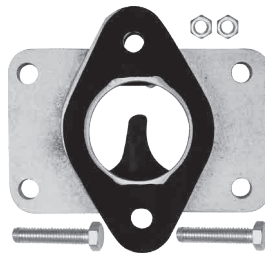

B-320A

ADAPTACIÓN

HOLLEY / HOLLEY 2 A 1 GARGANTA
CON TORNILLOS Y JUNTA

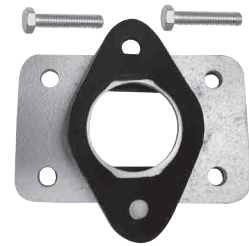

B-321A

ADAPTACIÓN

CARTER/HOLLY
2 GARGANTAS A 1 GARGANTA
CON TORNILLOS Y JUNTA

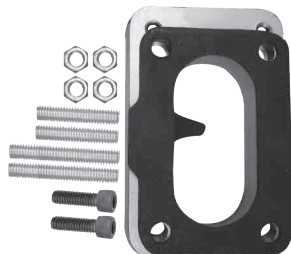

B-322A

ADAPTACIÓN

CARTER 2 GARG.
A HOLLEY 2 GARGANTAS
CON TORNILLOS Y JUNTA

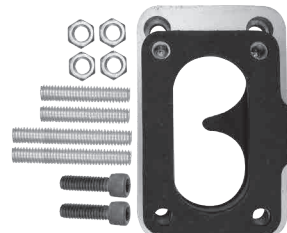

B-323A

ADAPTACIÓN

HOLLEY 2 GARG.
A CARTER 2 GARGANTAS.
CON TORNILLOS Y JUNTA



B-324A

ADAPTACIÓN

PIERBURG CORSAR T3, GOLF A2, A3,
JETTA y COMBI T2. 88/99
CON TORNILLOS Y JUNTA

BASES DE CARBURADOR

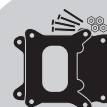

BASES DE CARBURADOR

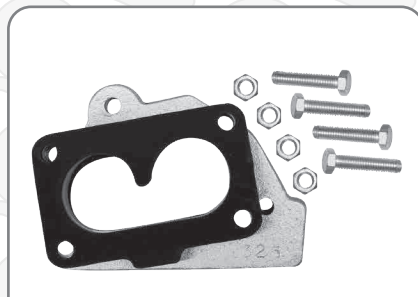

B-325A

ADAPTACIÓN

CHEVROLET TBI 2 GARGANTAS A
HOLLEY 2 GARGANTAS
CON TORNILLOS Y JUNTA

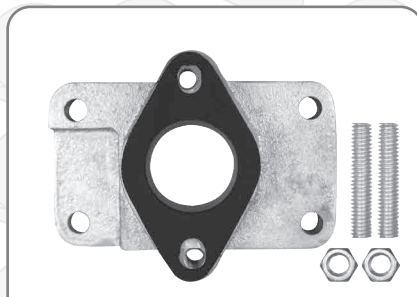

B-326A

ADAPTACIÓN

RENAULT 2LTS. / SOLEX TSURU
2 GARGANTAS A 1 GARGANTA
CON TORNILLOS Y JUNTA

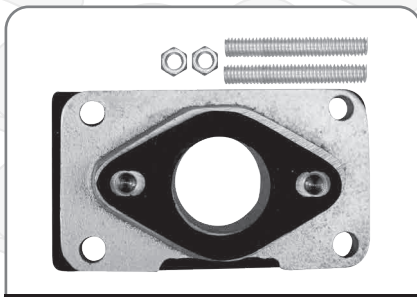

B-327A

ADAPTACIÓN

RENAULT
ALIANCE 2 GARGANTAS A SOLEX
NISSAN 1 GARGANTA.
CON TORNILLOS Y JUNTA



B-329A

ADAPTACIÓN

CHEV/ROCHESTER AMERICANO
4 A 2 GARGANTAS
CON TORNILLOS Y JUNTA



B-330A

ADAPTACIÓN

DUAL JET 2 GARGANTAS A FORD 2
GARGANTAS
CON TORNILLOS Y JUNTA

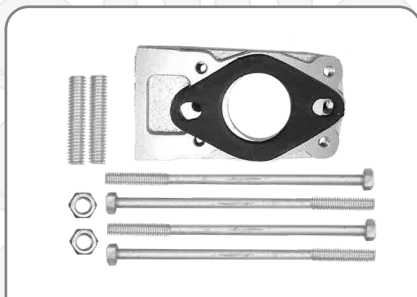

B-333A

ADAPTACIÓN

HITACHI 2 GARG. A SOLEX
(TSURU) 1 GARG.
CON TORNILLOS Y JUNTA

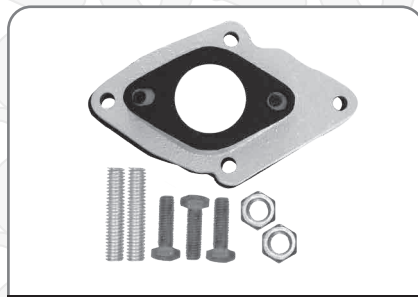

B-334A

ADAPTACIÓN

PIERBURG (VW)
2 GARG. A SOLEX (TSURU) 1 GARG. A2
CON TORNILLOS Y JUNTA

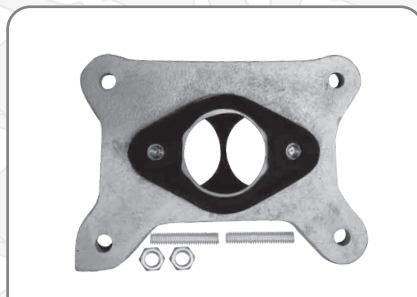

B-335A

ADAPTACIÓN

MOTORCRAFT 2 GARGANTAS
A HOLLEY 1 GARGANTAS
CON TORNILLOS Y JUNTA

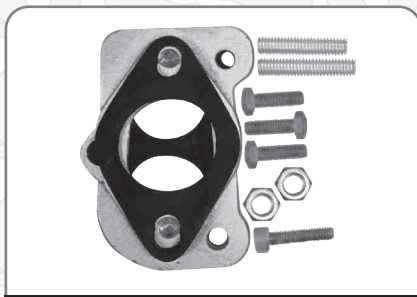

B-336A

ADAPTACIÓN

ADAPTACIÓN PIERBURG
(NISSAN) 2 GARG. A SOLEX (TSURU) 1
GARG.
CON TORNILLOS Y JUNTA

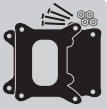

BASES DE CARBURADOR

BASES DE CARBURADOR



B-337A

ADAPTACIÓN

MOTORCRAFT 2 GARGANTAS A
HOLLEY 1 GARGANTA
CON TORNILLOS Y JUNTA

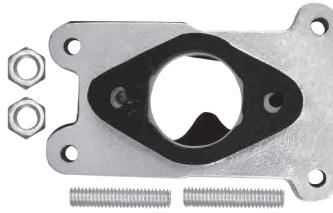

B-339A

CONVERSIÓN

CELEBRITY 2 GARG.
A HOLLEY 1 GARGANTA
CON TORNILLOS Y JUNTA

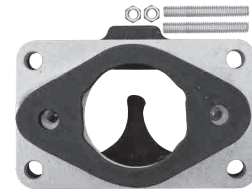

B-340A

ADAPTACIÓN

HOLLEY A HOLLEY 2 X 1 G.



B-343A

ADAPTACIÓN

TBI CHEVROLET 2 GARGANTAS A
QUADRAJET 1 GARGANTA

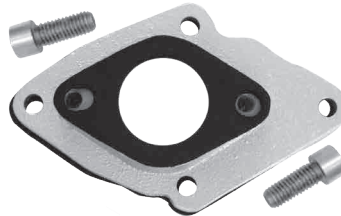

B-344A

ADAPTACIÓN

PIERBURG VOLKSWAGEN A
SOLEX 2 A 1 GARGANTA

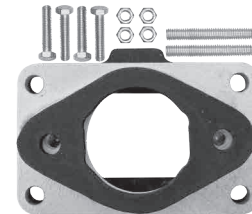

B-341A

ADAPTACIÓN

CARTER 2 GARGANTAS A HOLLEY 1 GARG.



B-345A

ADAPTACIÓN

AUMENTO 2 GARGANTAS PARA COUGAR
THUNDERBIRD Y FAIRMONT

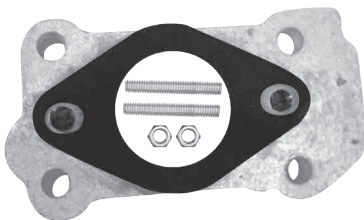

B-346A

ADAPTACIÓN

TSURU AUTOMATICO A SOLEX NISSAN
CON TORNILLOS Y JUNTA

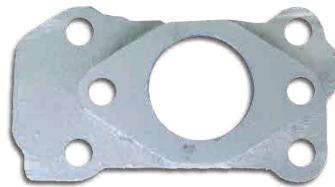

B-347A

ADAPTACIÓN

TSURU AUTOMATICO A SOLEX VW
CON TORNILLOS Y JUNTA



B-348A

ADAPTACION ROCHESTER
AMERICANO FORD 2 A 2 GARGANTAS
CON TORNILLOS Y JUNTA



DEPÓSITOS ANTICONGELANTES LIMPIAPARABRISAS Y TAPONES



Depósito sin tapón



Depósito con tapón



- 1.- Tapón
- 2.- Alimentador de Anticongelante
- 3.- Entrada para Manguera del Radiador
- 4.- Válvula de escape
- 5.- Soporte del depósito
- 6.- Punto de sujeción
- 7.- Punto de sujeción

DEPÓSITOS ANTICONGELANTES / LIMPIA PARABRISAS Y TAPONES

AUDI/ BMW

DEPÓSITOS ANTICONGELANTES

AUDI (VW)



121403B

Ref.: 21403B
DEPÓSITO ANTICONGELANTE

AUDI A3	97/03
GOLF y JETTA A4	99/06
SEAT LEÓN	01/06

No. Original: 1J0-121-403-B

Depósito CON TAPÓN
121403B-T
Ref.:21403B-T



121321B



121403L

Ref.: 21403L
DEPÓSITO ANTICONGELANTE

AUDI A4 1.8L , 4 CIL	98/02
A6 2.5 y 2.8L	96/02
PASSAT 2.8L, V6	

No. Original: 8D0-121-403-L

Depósito CON TAPÓN
121403L-T
Ref.:21403L-T



121321B

BMW



PRECIO ESPECIAL

471175

DEPÓSITO ANTICONGELANTE CON TAPÓN

SERIE 3 330, 325, 328 6 CIL	90/10
X3 2.0 & 2.5 y 3.0L, 6 CIL	-/08
X5 8 CIL	-/06

No. Original: 17 11 7 573 781
17 13 7 787 039



PRECIO ESPECIAL

471114

DEPÓSITO ANTICONGELANTE CON TAPÓN

SERIE 5 520I, 523I, 525I, 530I 3.0L	01/03
SERIE 5 528I & 528IT 3.0L	99/00

No. Original: 17 11 1 436 381



471122

TAPÓN PARA DEPÓSITO ANTICONGELANTE

SERIE 3 330, 325, 328 6 CIL	90/10
X3 2.0 & 2.5 & 3.0L, 6 CIL	-/08
X5 8 CIL (471175)	-/06
SERIE 5 520I, 523I, 525I, 530I 3.0L	01/03
SERIE 5 528I & 528IT 3.0L (471114)	99/00
SERIE 5 535I, 540I 3.0L	
SERIE 7 730I, 740I, 750I	91/03
MOTOR M73 3.0L (471167)	

No. Original: 17 11 1 742 232,
17 11 1 719 167, 17 11 2 242 256,
17 11 4 379 048



PRECIO ESPECIAL

471167

DEPÓSITO ANTICONGELANTE CON TAPÓN

SERIE 5 535I, 540I 3.0L	91/03
SERIE 7 730I, 740I, 750I MOTOR M73 3.0L	

No. Original: 17 11 1 741 167



CHRYSLER



5212510

DEPÓSITO ANTICONGELANTE
CON TAPÓN

SEBRING, STRATUS RT 2.4 y 3.0L, 4 CIL 01/05

No. Original: MR212510



5459619

TAPÓN P/ DEPÓSITO ANTICONGELANTE

JEEP LIBERTY 3.7L, V6 (59788AE) 99/06

No. Original: 0459198



52602AA

Ref.: 2602AA
DEPÓSITO ANTICONGELANTE

RAM PICK UP 3.7, 4.7 y 5.7L 02/UP

No. Original: 05072602AA



5520279

DEPÓSITO ANTICONGELANTE

COMANCHE, CHEROKEE,
WRANGLER, GRAND WAGONER 6 91/01
CIL RAM, CHARGER, RAM VAN,
WRANGLER 6 y 8 CIL 94/04

No. Original: 52027984, 52079331

Depósito CON TAPÓN
5520279-T



51074AB



558456A

DEPÓSITO ANTICONGELANTE

JOURNEY 3.6L, V6 09/18

No. Original: 05058456AE

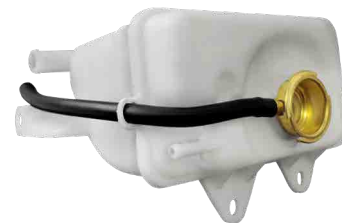

5592067

Ref.: 592067
DEPÓSITO ANTICONGELANTE

INTREPID-CONCORDE
3.5 L, 3.3L, 6 CIL 93/97

No. Original: 4592067

Depósito CON TAPÓN
5592067-T



5459619



5595575

Ref.: 595575
DEPÓSITO ANT. CON TAPÓN

STRATUS y CIRRUS 2.4L 95/00

No. Original: 04595575



DEPÓSITOS ANTICONGELANTES / LIMPIA PARABRISAS Y TAPONES

CHRYSLER (DODGE)

DEPÓSITOS ANTICONGELANTES



56258AC

Ref.: 6258AC
DEPÓSITO ANT. CON TAPÓN

STRATUS y CIRRUS 2,0L y 2,4L 01/UP

No. Original: 04596258AC



5596198

TAPÓN P/ DEPÓSITO ANTICONGELANTE

INTREPID-CONCORDE 6 CIL 3.5 L - 3.3 L 93/97
CADILLAC DEVILLE 00/05
BONEVILLE 04/05
BLAZER / JIMMY 4 CIL 2.2L 94/02
VOYAGER, NEON, PROWER, VIPER, 92/18
RAM, STRATUS-CIRRUS,
TOWN & COUNTRY, SEBRING,
LIBERTY, CRUISER,
GRAND CHEROKEE

No. Original: 04596198

APLICA PARA: 6603295



56387AA

Ref.: 6387AA
DEPÓSITO ANT. CON TAPÓN

DAKOTA, DURANGO 3.9 L, 6 CIL 97/00

No. Original: 4886387AA

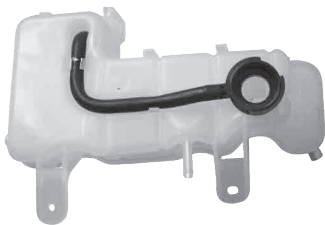

56466AG

DEPÓSITO ANTICONGELANTE

CHARGER, CHALLENGER, 05/10
300 5.7L, 8 CIL

No. Original: 04596466AG

(DODGE)



57295AA

DEPÓSITO ANT. CON TAPÓN

RAM 1500, 2500, 3500 & 4000 02/05
5.7L, 8 CIL

No. Original: 5072595AA,
55056502AA, 55056502AC



5746206

DEPÓSITO ANTICONGELANTE

NEON 1.8 y 2.0L, 4 CIL 95/99

No. Original: 04746206



58027AC

Ref.: 8027AC
DEPÓSITO ANT. CON TAPÓN

NEON 2.0L 00/06

No. Original: 05278027AC

Depósito CON TAPÓN
5746206-T



5796447



58498AC-1

DEPÓSITO ANT. CON TAPÓN

PACIFICA 3.8 y 4.0L, 6 CIL	04/08
----------------------------	-------

No. Original: 04880498AC



58269AB

Ref.: 8269AB

DEPÓSITO ANTICONGELANTE

CONCORDE-INTREPID-300M 3.5L, 3.2L, 6 CIL	97/03
--	-------

No. Original: 4758269AB

(DODGE)



58977AA

DEPÓSITO ANT. CON TAPÓN

NEON 2.0L, 4 CIL	01/06
------------------	-------

No. Original: 5018977AA



51074AB

TAPÓN P. DEPÓSITO ANTICONGELANTE

COMANCHE, CHEROKEE SPORT, WRANGLER, GRAND WAGONER 6 CIL	91/01
RAM, CHARGER, RAM VAN, WRANGLER 6 & 8 CIL	94/04
SPIRIT, SHADOW, VOYAGER, AVENGER, PATRIOT, CALIBER, DURANGO, NEON	82/16

No. Original: 55111074AB

APLICA PARA: 5520279

Depósito CON TAPÓN

58269AB-T

Ref.: 8269AB-T



677528



59421AA

DEPÓSITO ANT. CON TAPÓN

GRAND CHEROKEE 4.0 y 5.2L, 6 y 8 CIL	02/05
--------------------------------------	-------

No. Original: 5069421AA



5796447

TAPÓN P. DEPÓSITO ANTICONGELANTE

NEON 1.8 y 2.0L, 4 CIL	95/99
------------------------	-------

No. Original: 04796447

APLICA PARA: 5746206



592333

TAPÓN DE RADIADOR/ 13 LBS.

SEBRING 2.6L V6	95/97
DODGE ATOS 1.0L, 4 CIL/ GASOLINA 1.1 L	00/04
DODGE ATOS 1.0L, 4 CIL/GASOLINA 1.1 L	09/12
DODGE H100 2.5L, 4 CIL/ DIESEL	06/10

DEPÓSITOS ANTICONGELANTES / LIMPIA PARABRISAS Y TAPONES

CHRYSLER/ FIAT / FORD

DEPÓSITOS ANTICONGELANTES



59788AE

Ref.: 9788AE
DEPÓSITO ANTICONGELANTE

JEEP LIBERTY 3.7L, V6 99/06

No. Original: 52079788AE

Depósito CON TAPÓN
59788AE-T

Ref.: 9788AE-T



5459619



592527

TAPÓN DE RADIADOR / 13 LBS.

CHEROKEE 4.0L, V6 91/95



593528

TAPÓN P/DEPÓSITO Y RADIADOR 16 LBS

CONCORDE 2.7, 3.2, 3.3 y 3.5L V6	93/04
INTREPID 2.7, 3.2, 3.3 y 3.5L V6	94
INTREPID 2.7, 3.2, 3.3 y 3.5L V6	97/07
NEW YORKER 3.5L V6	94/96
SEBRING 2.5L V6	97
SEBRING 2.5L V6	99/00
DURANGO 5.2 y 5.9L, V8	98/99
NEON 2.0 y 2.4L, 4 CIL	96/04
RAM 1500 3.9L V6	99
RAM 4000 5.9 y 6.7L DIESEL	08/13
200 3.6L, V6 GASOLINA	11/12
300M 3.5L, V6 GASOLINA	04
AVENGER 2.0 y 2.4L	08/09
JOURNEY 2.4, 3.5 & 3.6L, V6	09/13
RAM SERIES PICK-UP 3.7L, V6, 4.7L, V8	02/03
STRATUS 2.0L, 2.7L, 4 CIL, V6	02
COMPASS 2.4L, 4 CIL	07/11
LIBERTY 3.7L V6	03/07
PATRIOT 2.4L, 4 CIL	07/14
PT CRUISER 2.4L, 4 CIL DOHC	03

APLICA PARA: 8269AB

FIAT

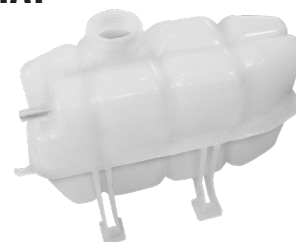

4468159

DEPÓSITO ANTICONGELANTE

PALIO ADVENTURE 1.8L, 4 CIL 01/17

No. Original: 46815905

FORD



708065E

DEPÓSITO ANT. CON TAPÓN

FUSION 2.3L, 4 CIL 05/12

No. Original: 6E5Z-8A080-AA



Salidas reforzadas



7104120

Ref.: 104120

DEPÓSITO ANTICONGELANTE

FOCUS USA 2.0 SPI y 2.0 ZETEC 01/04

No. Original: 98AB-8K218-AK

Depósito CON TAPÓN

7104120-T

Ref.: 104120-T



7163500



718080B

Ref.: 18080B

DEPÓSITO ANTICONGELANTE

TAURUS, SABLE 3.0L, 24V, 6 CIL 96/03

No. Original: 1F1Z-8A080-BA

Depósito CON TAPÓN
718080B-T

Ref.:18080B-T



7163500

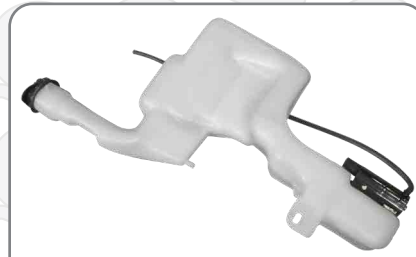

717618A

Ref.: 17618A

DEPÓSITO LIMPIA PARABRISAS
CON TAPÓN

FIESTA 1.6, 4 CIL (CHISGUETERO) 11/UP

No. Original: BE8Z-17618-A



722176L

DEPÓSITO LIMPIA PARABRISAS
CON TAPÓN

EXPLORER, RANGER 2.5L, 6 CIL 02/03
RANGER ARGENTINA 4.0L, 6 CIL

No. Original: 2L2Z-17618-AA,
8L2Z-17618-A, F57Z-17618-AA



711808A

Ref.: 11808A

DEPÓSITO ANTICONGELANTE

TAURUS SABLE 3.0L, 6 CIL 99/06

No. Original: 1F1Z-8A080-AA

Depósito CON TAPÓN
711808A-T

Ref.:11808A-T



7163500

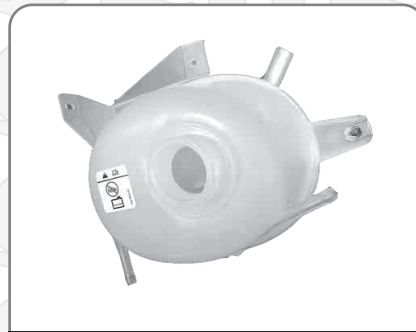

7258080A

Ref.: 258080A

DEPÓSITO ANTICONGELANTE

RANGER ARGENTINO 2.3L, 4 CIL 02/07

No. Original: 2L5Z-8A080-AA

Depósito CON TAPÓN
7258080A-T

Ref.:258080A-T



7163500



728A080

Ref.: 28A080

DEPÓSITO ANTICONGELANTE

WINDSTAR 3.8L, 6 CIL 95/05

No. Original: XF2Z-8A080-AA

Depósito CON TAPÓN
728A080-T

Ref.:28A080-T



7163500



DEPÓSITOS ANTICONGELANTES / LIMPIA PARABRISAS Y TAPONES

FORD

DEPÓSITOS ANTICONGELANTES



73288AA

DEPÓSITO ANT. CON TAPÓN

EXPLORER MOUNTAINEER 4.6L, 8 CIL	00/05
F150, LINCOLN, LOBO 5.4L, 8 CIL	03/04

No. Original: 3L2Z-8A080-AA, 3L3Z-8A080-AB



733638E

DEPÓSITO ANTICONGELANTE

F250, F350, F450, F550 SD 6.0L, 8 CIL	05/10
TRITON V10	99/08

No. Original: 3C3Z-8A080-AE, 6C3Z-8A080-B

Depósito CON TAPÓN
733638E-T



7938101



733808A

DEPÓSITO ANT. CON TAPÓN

F150, LOBO, LINCOLN 5.4L, 8 CIL	03/04
---------------------------------	-------

No. Original: 3L3Z-8A080-AB, YL3Z-8A080-AA



738080R

DEPÓSITO ANT. CON TAPÓN

MUSTANG V6 4.0L, 8 CIL	04/14
------------------------	-------

No. Original: 4R3Z-8A080-AA



753880L

DEPÓSITO ANT. CON TAPÓN

EXPEDITION, LOBO, LINCOLN 5.4L, 8 CIL	04/06
---------------------------------------	-------

No. Original: 5L3Z-8A080-AA



7428A80

DEPÓSITO ANTICONGELANTE SIN PIVOTE

ECONOLINE E150, E250, E350 5.4L, 8 CIL	04/07
--	-------

No. Original: 4C2Z-8A080-BC

Depósito CON TAPÓN
7428A80-T



7163500



74808CA

DEPÓSITO ANT. CON TAPÓN

EDGE 3.5L, 8 CIL	06/09
EDGE 2.0L, 8 CIL	09/11
EDGE 3.7L, 8 CIL	12/14
LINCOLN MKX 3.5L, 4 CIL	07/15

No. Original: 7T4Z-8A080-A, 9T4Z-8A080-A, AT4Z-8A080-CA



7216078-1

TAPÓN P/ DEPÓSITO ANTICONGELANTE: AMARILLO

FIESTA IKON HATCH 4 CIL 1.4L ZETEC (MERCADO INDU) 10/15

No. Original: 1216078

APLICA PARA: 76181AB-1



CON ENTRADA PARA SENSOR

758808A

Ref.: 58808A
DEPÓSITO ANTICONGELANTE

FORD ESCAPE 3.0L, 6 CIL 01/04

No. Original: 5L8Z-8A080-AA

Depósito CON TAPÓN 758808A-T

Ref.: 58808A-T



7L84810



76181AB-1

DEPÓSITO ANTICONGELANTE

FIESTA, IKON HATCH 1.4L, 4 CIL ZETEC (MERCADO HINDÚ) 10/15

No. Original: XF61-8100-AB

Depósito CON TAPÓN 76181AB-1-T



7216078-1



762828C

DEPÓSITO ANT.CON TAPÓN

EXPLORER SPORT TRACK 4.6L, 8 CIL 06/10
MERCURY MOUNTAINEER 4.6L, 8 CIL 07/10

No. Original: 6L2Z-8A080-C,
8L2Z-8A080-B



768A080

Ref.: 68A080
DEPÓSITO ANTICONGELANTE

TAURUS, SABLE 3.0L, 6 CIL 96/99

No. Original: F6DZ-8A080-B

Depósito CON TAPÓN 768A080-T

Ref.: 68A080-T



7938101



77618AD

Ref.:7618AD
DEPÓSITO LIMPIA PARABRISAS

FIESTA SEDAN//HATCH 02/07

No. Original: 2S65-17618-AD

Depósito CON TAPÓN 77618AD-T

Ref.:7618AD-T



77606AB



771761B

DEPÓSITO ANT. CON TAPÓN

RANGER, F350, F150 2.3L, 4 CIL 1989

No. Original: E7TZ-17618-B



DEPÓSITOS ANTICONGELANTES / LIMPIA PARABRISAS Y TAPONES

FORD

DEPÓSITOS ANTICONGELANTES



780827W

DEPÓSITO ANT. CON TAPÓN

GRAN MARQUIZ, CROWN VICTORIA 4.6L, 8 CIL LINCOLN 4.6L, 8 CIL	2002 03/06
--	---------------

No. Original: 2W7Z-8A080-AA,
3W1Z-8A080-AA



78A080B

Ref.:8A080B
DEPÓSITO ANT. CON TAPÓN

MUSTANG 5.0L, 8 CIL	94/95
---------------------	-------

No. Original: F4ZZ-8A080-B



78880AE

Ref.:8880AE

DEPÓSITO ANTICONGELANTE

ESCAPE, TRIBUTE 2.0L, 6 CIL, 16V	00/06
----------------------------------	-------

No. Original: YL8Z-8A080-AE

Depósito CON TAPÓN
78880AE-T

Ref.: 8880AE-T



7L84810



788080B

Ref.:88080B

DEPÓSITO ANTICONGELANTE

FORD ESCAPE 3.0L, 6 CIL -CON SENSOR-	01/06
---	-------

No. Original: 1L8Z-8A080-BB

Depósito CON TAPÓN
788080B-T

Ref.: 88080B-T



7L84810



78K218B

Ref.: 8K218B

DEPÓSITO ANTICONGELANTE

FORD FIESTA FIRST y SEDAN (2 SALIDAS)	2003
--	------

No. Original: 2S65-8K218-B
2S65-8K218-AC

Depósito CON TAPÓN
78K218B-T

Ref.: 8K218B-T



7163500



7A080AA

Ref.: A080AA

DEPÓSITO ANTICONGELANTE

EXCURSION F250, 350, 450 y 550 SD (ACORDEON)	98/05
---	-------

No. Original: 2C3Z-8A080-AA

Depósito CON TAPÓN
7A080AA-T

Ref.:A080AA-T



7163500



7C428AA

Ref.: C428AA
**DEPÓSITO ANTICONGELANTE
UNA SALIDA**

E-350 & E-450 SUPER DUTY, 04/07
ECONOLINE DIESEL 5.0 L, 8 CIL

No. Original: 4C2Z-8A080-AA

**Depósito CON TAPÓN
7C428AA-T**
Ref.: C428AA-T



7163500



7C617CA

Ref.: C617CA
**DOBLE DEPÓSITO ANTICONGELANTE-
LIMPIAPARABRISAS**

RANGER DOBLE DEP 2.3L, 2.4L, 04/12
3.0L, 4 CIL

No. Original: 7L551-7C617-CA

**Depósito CON TAPÓN
7C617CA-T**
Ref.: C617CA-T



7163500



7E88080

Ref.: E88080
DEPÓSITO ANTICONGELANTE

FIESTA 1.8L, 4 CIL 11/UP

No. Original: BE8Z-8A080-A

**Depósito CON TAPÓN
7E88080-T**
Ref.: E88080-T



7E88100



7K218AA

Ref.: K218AA
DEPÓSITO ANTICONGELANTE

KA 1.6L TODOS

No. Original: 98KU-8K218-AA

**Depósito CON TAPÓN
7K218AA-T**
Ref.: K218AA-T



7163500



7K218AG

Ref.: K218AG
DEPÓSITO ANTICONGELANTE

COURIER 1.6L 01/UP

No. Original: 96FB-8K218-AG

**Depósito CON TAPÓN
7K218AG-T**
Ref.: K218AG-T



7163500



7K218BA

Ref.: K218BA
DEPÓSITO ANTICONGELANTE

FIESTA, ECOSPORT (1 SALIDA) 04/10

No. Original: 2565-8K218-BA

**Depósito CON TAPÓN
7K218BA-T**
Ref.: K218BA-T



7163500



DEPÓSITOS ANTICONGELANTES / LIMPIA PARABRISAS Y TAPONES

FORD

DEPÓSITOS ANTICONGELANTES



7K218BG

Ref.: K218BG

DEPÓSITO ANTICONGELANTE

FIESTA 1.3 y 1.4L, 4 CIL

98/01

No. Original: 96FB-8K218-BG

Depósito CON TAPÓN
7K218BG-T

Ref.: K218BG-T



7163500



7K218CB

Ref.: K218CB

DEPÓSITO ANTICONGELANTE

COURIER 1.6L, 4CIL
SIN AIRE

02/08

No. Original: 96FB-8K218-CB

Depósito CON TAPÓN
7K218CB-T

Ref.: K218CB-T



7163500



7K218DG

Ref.: K218DG

DEPÓSITO ANTICONGELANTE

FOCUS EUROPEO 1.6L, 4 CIL

03/08

No. Original: 3M5H-8K218-DG

Depósito CON TAPÓN
7K218DG-T

Ref.: K218DG-T



7E88100



7K218BB

DEPÓSITO ANTICONGELANTE

ECO SPORT y FIGO 1.6L 4 CIL

14/16

No. Original: 8V21-8K218-BB

Depósito CON TAPÓN
7K218BB-T



7E88100

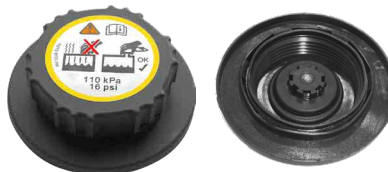

7163500

TAPÓN PARA DEPÓSITO ANTICONGELANTE

Ref.: 163500

No. Original: 7S55-8100-AA

FOCUS USA 2.0 SPI y 2.0 ZETEC (7104120)

TAURUS SABLE 6 CIL 3.0L (711808A)

TAURUS SABLE 24V 6 CIL 3.0 L (718080B)

RANGER ARGENTINO 4 CIL. 2.3L (7258080A)

WINDSTAR 3,8L 6 CIL. (728A080)

FIESTA FIRST y SEDAN (2 SALIDAS) (78K218B)

EXCURSION F250, 350, 450 Y 550 SD (ACORDEON) (7A080AA)

E-350 & E-450 SUPER DUTY, ECONOLINE DIESEL 8 CIL 5.0 L (7C428AA)

RANGER DOBLE DEP 2.3L, 2.4L, 3.0L 4 CIL (7C617CA)

Ka 1.6L (7K218AA)

COURIER 1.6L (7K218AG)

FIESTA, ECOSPORT (1 SALIDA) (7K218BA)

FIESTA 1,3 y 1,4L 4CIL (7K218BG)

COURIER 1,6L 4 CIL (SIN AIRE) (7K218CB)

ECONOLINE E150 ,E250 ,E350 5.4 L 8CIL (7428A80)

LINCOLN LS, THUNDERBIRD 6 CIL 3.0 L (75408AA)

01/04

99/06

96/03

02/07

95/05

2003

98/05

04/07

04/12

TODOS

01/UP

04/10

98/01

02/08

04/07

00/06



78100AA

TAPÓN PARA DEPÓSITO ANTICONGELANTE (AMARILLO)

Ref.:8100AA

No. Original: 7555-8100-AA

FOCUS USA 2.0 SPI y 2.0 ZETEC (7104120)	01/04
TAURUS SABLE 3.0L ,6 CIL (711808A)	99/06
TAURUS SABLE 3.0L, 6 CIL, 24V (718080B)	96/03
RANGER ARGENTINO 2.3L, 4 CIL (7258080A)	02/07
WINDSTAR 3.8L, 6 CIL (728A080)	95/05
FIESTA FIRST y SEDAN (2 SALIDAS) (78K218B)	2003
EXCURSION F250, 350, 450 y 550 SD (ACORDEON) (7A080AA)	98/05
E-350 & E-450 SUPER DUTY, ECONOLINE DIESEL 5.0L, 8 CIL (7C428AA)	04/07
RANGER DOBLE DEP 2.3L, 2.4L y 3.0L, 4 CIL (7C617CA)	04/12
Ka 1.6L (7K218AA)	TODOS
COURIER 1.6L (7K218AG)	01/UP
FIESTA, ECOSPORT (1 SALIDA) (7K218BA)	04/10
FIESTA 1.3l y 1.4L, 4CIL (7K218BG)	98/01
COURIER 1.6L, 4 CIL SIN AIRE (7K218CB)	02/08
ECONOLINE E150 ,E250 ,E350 5.4 L, 8CIL (7428A80)	04/07



77606AB

Ref.:7606AB

TAPÓN PARA DEPÓSITO LIMPIAPARABRISAS

FIESTA SEDAN//HATCH

02/07

No. Original: 2S651-7K606-AB

APLICA PARA: 77618AD



7E88100

Ref.:E88100

TAPÓN P/ DEP. ANTICONGELANTE

FIESTA 1.8L, 4 CIL (7E88080)	11/UP
FOCUS EUROPEO 1.6L, 4 CIL (7K218DG)	03/08
MAZDA 3 2.0L y 2.5L, 4 CIL (981535B)	06/13
ESCAPE 2.0L y 2.5L, 4 CIL TURBO	
FOCUS RS 2.3L, 4 CIL TURBO (780806C-1)	14/17
ESCAPE, FOCUS EUROPA 1.6L, 4 CIL (768080A)	12/16
ECOSPORT y FIGO 1.6L, 4 CIL (7K218BB)	14/16

No. Original: BE8Z-8100-A



7L84810

Ref.:L84810

TAPÓN P/ DEP. ANTICONGELANTE

ESCAPE 3.0L, 6 CIL. SIN SENSOR (758808A)	06/07
ESCAPE, TRIBUTE 2.0L, 6 CIL, 16V (78880AE)	00/06
FORD ESCAPE 3.0L, 6 CIL C/SENSOR(788808B)	01/06

No. Original: YL84-8100-A



784333

TAPÓN DE RADIADOR / 13 LBS.

ESCORT 1.8L y 1.9L, 4 CIL	91/96
MUSTANG 3.8L, V6	95/96
MUSTANG V8 4.6L y 5.0L	95/96
MERCURY MYSTIQUE 2.0L, 4 CIL	95/96
MERCURY MYSTIQUE 2.5L, V6	95/96
MERCURY VILLAGER 3.0L, V6	93/97



DEPÓSITOS ANTICONGELANTES / LIMPIA PARABRISAS Y TAPONES

FORD

DEPÓSITOS ANTICONGELANTES



781336

TAPÓN DE RADIADOR / 16 LBS.

ESCORT 1.8, 1.9 y 2.0L, 4 CIL	95/98
EXPLORER 4.0L, V6	95/03
EXPLORER 4.0, 4.6, 5.0, 5.4 y 5.8L, V8	95/03
MUSTANG 3.8L, V6	98/01
RANGER 2.3 y 2.5L, 4 CIL	96/02
RANGER 3.0 y 4.0L, V6	96/02
THUNDERBIRD 3.8L, V6	91/94
THUNDERBIRD 5.0L, V8	91/94
TOPAZ 2.0 y 2.3L, 4 CIL	90/96
TOPAZ 3.0 y 3.8L, V6	90/96
WINDSTAR 3.8 y 4.0L, V6	95/00
ESCORT ZX2 2.0L, 4 CIL	99
COUGAR 3.8L, V6	90/97
COUGAR 5.0L, V8	90/97
GHIA 2.3L, 4 CIL	90/96
GHIA 3.0L, V6	90/96
EXPEDITION 5.4L, V8 /GASOLINA	09/14
EXPLORER 4.0L, V6	95/03
EXPLORER 4.6, 5.0, 5.4 y 5.8L, V8 /GASOLINA	95/03
EXPLORER SPORT TRACK 4.0L, V6/GASOLINA	01/05
F SERIES PICK-UP 4.6, 5.4 y 6.2L, V8 /GASOLINA	09/11
F-150 4.6L, V8/ GASOLINA	09/10
F-350 SUPER DUTY 5.4L, V8/ GASOLINA	07/09
LOBO 4.6 y 5.4L, V8/GASOLINA	09/10
MUSTANG 3.8L, V6/ GASOLINA	98/01
RANGER 2.3 y 2.5L, 4 CIL / GASOLINA	96/97
RANGER 2.3 y 2.5L, 4 CIL/ GASOLINA	99/02
RANGER 3.0 y 4.0L V6/ GASOLINA	96/97
RANGER 3.0 y 4.0L V6/GASOLINA	99/02
WINDSTAR 3.0, 3.8 y 4.0L, V6	95/00
NAVIGATOR 5.4L, V8/ GASOLINA	09



780526

TAPÓN DE RADIADOR/ 7 LBS.

<i>SIN PALANCA</i>	
F-600 CUMMINS B SERIES 5.9L/ DIESEL	91/94
F-600 CUMMINS C SERIE 8.3L/ DIESEL	91/94
F-600 6.6 y 7.8L, 6 CIL/ DIESEL	91/94
F-600 6.1 y 7.0L/ V8	91/94



785528

TAPÓN DE RADIADOR/ 16 LBS.

ASTRO 3.0, 3.8 & 4.0L V6	94/97
CROWN VICTORIA 4.6L V8	92
FAIRMONT 2.3L, 4 CIL	80/83
FAIRMONT 3.3 & 3.8L, V6	80/83
FAIRMONT 4.2 & 5.0L, V8	80/83
MUSTANG 2.3L, 4 CIL	80/84
MUSTANG 3.3 & 3.8L, V6	80/84
MUSTANG 4.2 & 5.0L, V8	80/84
TAURUS 3.8L, V6	90
THUNDERBIRD 2.3L, 4 CIL	85
THUNDERBIRD 3.8L, V6	85
TOPAZ 2.0 & 2.3L, 4 CIL	84/85
TOPAZ 3.0 & 3.8L, V6	84/85
LINCOLN TOWN CAR 4.6L, V8	91/92
COUGAR 2.3L, 4 CIL	85
COUGAR 3.3 & 3.8L, V6	85
COUGAR 5.0L, V8	85
GRAND MARQUIS 3.8L, V6	82/84
GRAND MARQUIS 3.8L, V6	92
GRAND MARQUIS 4.2, 4.6, 5.0 & 5.8L, V8	82/84
GRAND MARQUIS 4.2, 4.6, 5.0 & 5.8L, V8	92



784527

TAPÓN DE RADIADOR/ 13 LBS.

ASTRO 2.3L, 4 CIL	86/93
ASTRO 3.0 & 4.0L, V6	86/93
EXPLORER 4.0L, V6	91/94
EXPLORER 4.0L, V6	98/99
EXPLORER 4.0, 5.0, 5.4 & 5.8L, V8	91/94
EXPLORER 4.0, 5.0, 5.4 & 5.8L, V8	98/99
F SERIES PICK-UP 4.9L, V6	80/96
F SERIES PICK-UP V8	91/94
F SERIES PICK-UP V8	98/99
F SERIES PICK-UP 5.0 & 5.8L, V8	80/96
F-150 4.9L, V6	95/96
F-200 5.0 & 5.8L, V8	90/94
F-250 5.0L, V8	95/96
F-350 MICRO 5.8L, V8	90/97
F-350 SUPER DUTY 5.0 & 5.8L, V8	90/97
F-450 SUPER DUTY 7.5L V8 /DIESEL	97
RANGER 2.0 & 2.3L, 4 CIL	83/93



7938101

TAPÓN P/DEPÓSITO ANTICONGELANTE

F250, F350, F450, F550 SD 6.0L, 8CIL	05/10
TRITON V10 (733638E)	99/08
TAURUS, SABLE 3.0L, 6 CIL (768A080)	96/99
SATURN SC, SL 92-02, SW 1.9L (6103088)	93/01
F-250/F-350/F-450/F-550 6.2L V8 DIESEL	07/15
EDGE 2.0L DOHC 16 V	
EXPLORER 2.0 DOHC 16 V	
FUSION 2.5L, 16 V	
MUSTANG 4.6L, 12 V	
ECONOLINE 6.8L, 16 V	
EXPEDITION 5.4L, 16V	
LOBO 5.0L V8	
RANGER 2.3L, 4 CIL	

No. Original: 9C3Z-8101-B



NUEVO

768080A

DEPÓSITO ANTICONGELANTE

ESCAPE, FOCUS EUROPA 1.6L, 4 CIL	12/16
-------------------------------------	-------

No. Original: CV6Z-8A080-A

**Depósito CON TAPÓN
768080A-T**



7E88100



NUEVO

780806C-1

DEPÓSITO ANTICONGELANTE

ESCAPE 2.0L y 2.5L, 4 CIL TURBO FOCUS RS 2.3L, 4 CIL TURBO	14/17 12/16
---	----------------

No. Original: CV6Z-8A080-C

**Depósito CON TAPÓN
780806C-1-T**



7E88100

GIANT MOTORS(FAW)



996333

TAPÓN DE RADIADOR/ 13 LBS.

GF-8 1.0L, 4 CIL GF-900 1.0L, 4 CIL	07/08 07/08
--	----------------

GENERAL MOTORS



6038190

DEPÓSITO ANT. CON TAPÓN

SATURN VUE 2.2L, 4 CIL EQUINOX	02/08 06/13
-----------------------------------	----------------

No. Original: 10381902



6104026

DEPÓSITO ANT. CON TAPÓN

CAMARO & PONTIAC FIREBIRD 5.7L, 8 CIL	93/02
--	-------

No. Original: 10188034, 10402687,
26032950



6132568

Ref.: 132568
DEPÓSITO ANTICONGELANTE

CRUZE 6 CIL BUICK VERANO 6 CIL	10/13 12/13
-----------------------------------	----------------

No. Original: 13256823

**Depósito CON TAPÓN
6132568-T**



6502353



DEPÓSITOS ANTICONGELANTES / LIMPIA PARABRISAS Y TAPONES

GENERAL MOTORS

DEPÓSITOS ANTICONGELANTES



6104213

DEPÓSITO ANT. CON TAPÓN

MALIBU, GRAND AM 3.1 y 3.4L, 6 CIL 97/03

No. Original: 10314213
12365309, 15066786



6132224

DEPÓSITO ANTICONGELANTE

MALIBU 2.0L, 4 CIL 03/15
BUICK LACROSSE 2.4L, 4 CIL 10/13
BUICK REGAL 2.4L, 4 CIL 11/13
CADILLAC XTS 2.0L, 4 CIL 2013

No. Original: 13220124

**Depósito CON TAPÓN
6132224-T**



6150751



6158572

DEPÓSITO ANTICONGELANTE

SILVERADO 2500, 3500 6.6L, V8 01/07
SIERRA 2500, 3500 6.6L, V8 01/07
AVALANCHE 6.6L, 8 CIL 03/07

No. Original: 15085725, 15808714

**Depósito CON TAPÓN
6158572-T**



6150751



6191261

DEPÓSITO ANTICONGELANTE

CADILLAC EL DORADO 4.6L, 8 CIL 92/97
CADILLAC DEVILLE 4.6L, 8 CIL 94/99
CADILLAC SEVILLE 4.6L, 8 CIL 93/97

No. Original: 19129961

**Depósito CON TAPÓN
6191261-T**



780526



6227110

**DEPÓSITO LIMPIA PARABRISAS
CON TAPÓN**

MALIBU 3.5L, 6 CIL 07/10
PONTIAC G6 3.5L, 6 CIL 05/10
SATURN AURA 3.5L, 6 CIL 07/09

No. Original: 22711037



6236339

DEPÓSITO ANT. CON TAPÓN

ASTRO y SAFARI 4.3L, 6 CIL 95/05

No. Original: 12363309, 15060681



6257752

DEPÓSITO ANTICONGELANTE

MALIBU 2.2 & 3.5L, 6 CIL	05/10
PONTIAC G6 2.2L, 6 CIL	05/09

No. Original: 25775252



6263588

DEPÓSITO ANT. CON TAPÓN

CADILLAC DEVILLE 4.6L, 8 CIL	03/04
CADILLAC SEVILLE 4.6L, 8 CIL	98/04

No. Original: 25635588



6367722

Ref.: 367722
DEPÓSITO ANTICONGELANTE

CORSA y TORNADO	06/08
CON AIRE ACONDICIONADO	

No. Original: 93367722

Depósito CON TAPÓN

6367722-T
Ref.: 367722-T



6220885



6367723

Ref.: 367723
DEPÓSITO ANTICONGELANTE

CORSA y TORNADO	03/05
SIN AIRE ACONDICIONADO	

No. Original: 93367723

Depósito CON TAPÓN

6367723-T
Ref.: 6367723-T



6220885



6386398

Ref.: 386398
**DEPÓSITO LIMPIAPARABRISAS
CON TAPÓN / MOTOR**

CHEVY 1.4 y 1.6L, 4 CIL	94/12
-------------------------	-------

No. Original: 90386398



64150AM

Ref.: 4150AM
DEPÓSITO ANTICONGELANTE

CHEVY 1.4L, 1.6L, 4 CIL	94/11
-------------------------	-------

No. Original: 90410057, 93217461

Depósito CON TAPÓN

64150AM-T
Ref.: 4150AM-T



6220885



6487670

DEPÓSITO ANT. CON TAPÓN

AVALANCHE, SILVERADO, HEAVY DUTY 3500 5.3L, 8 CIL	10/UP
--	-------

No. Original: 12487670



DEPÓSITOS ANTICONGELANTES / LIMPIA PARABRISAS Y TAPONES

GENERAL MOTORS

DEPÓSITOS ANTICONGELANTES

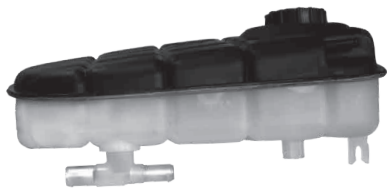

6430189

DEPÓSITO ANT. CON TAPÓN

CORVETTE 5.7L, 8 CIL 00/04

No. Original: 10430189



6473615

Ref.: 473615
DEPÓSITO ANTICONGELANTE

TORNADO 1.8L, 4 CIL 10/14

No. Original: 94736156

Depósito CON TAPÓN
6473615-T
Ref.: 473615-T



6332652



6516167

DEPÓSITO ANT. CON TAPÓN

KODIAK 8.1L, 8 CIL 03/09
KODIAK/ TOPKICK C4500,
C5500, C6500, C7500, C8500

No. Original: 15161670



6575570

Ref.: 575570
DEPÓSITO ANT. CON TAPÓN

S10 BLAZER, JIMMY, SONOMA,
BRAVADA 4.3L, 8 CIL 95/05

No. Original: 15075570



6521694

Ref.: 521694
DEPÓSITO ANTICONGELANTE

AVEO 1.6L, 4 CIL 09/13

No. Original: 95216944

Depósito CON TAPÓN
6521694-T
Ref.: 521694-T



6420303



6562624

Ref.: 562624
DEPÓSITO ANTICONGELANTE

MATIZ G1 1.0L, 4 CIL 03/08
SPARK 1.2 y 1.4L, 4 CIL 12/16

No. Original: 96562624

Depósito CON TAPÓN
6562624-T
Ref.: 562624-T



6420303



6579336

DEPÓSITO ANTICONGELANTE

MALIBU 2.4L, 4 CIL 04/06
PONTIAC G6 3.5L, 6 CIL 05/06

No. Original: 15793368

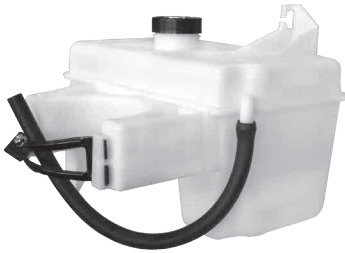

6588433

DEPÓSITO ANT. CON TAPÓN

TRAIL BLAZER SSR 4.2L, 6 CIL	00/09
BUICK RAINIER 3.5L, 6 CIL	04/07
GMC ENVOY 4.2L, 6 CIL	02/09
ISUZU ASCENDER 4.2L, 6 CIL	03/08
BRAVADA 4.2L, 6 CIL	02/04
SAAB 9-7X 4.2L, 6 CIL	05/09

No. Original: 15884833, 25780737, 25870737



6591467

Ref.: 591467

DEPÓSITO ANTICONGELANTE

MATIZ G2 y SPARK 1.0L, 4 CIL	06/10
------------------------------	-------

No. Original: 96591467

Depósito CON TAPÓN

6591467-T

Ref.: 591467-T



6420303



6595742

Ref.: 595742

DEPÓSITO ANT. CON TAPÓN

VAN 4.3L, 5.7L y 6.2L, 6 CIL y 8 CIL	84/91
--------------------------------------	-------

No. Original: 15595742



6650373

Ref.: 650373

DEPÓSITO ANT. CON TAPÓN

SILVERADO, BLAZER, SUBURBAN 4.3L, 5.7L, 7.4L 6 CIL y 8 CIL	88/02
--	-------

No. Original: 15650373



6603295

Ref.: 603295

DEPÓSITO ANTICONGELANTE

CADILLAC DEVILLE	00/05
BONEVILLE	04/05
BLAZER / JIMMY 2.2L, 4 CIL	94/02

No. Original: 26032950

Depósito CON TAPÓN

6603295-T

Ref.: 603295-T



5596198



6677855

Ref.: 677855

DEPÓSITO ANTICONGELANTE

CORVETTE 3.1L, 6 CIL	84/96
CAVALIER 3.1L, 6 CIL	95/05
MALIBU 3.1L, 6 CIL	99/05

No. Original: 22677855

Depósito CON TAPÓN

6677855-T

Ref.: 677855-T



6571316



6778386

Ref.: 778386

DEPÓSITO ANT. CON TAPÓN

AVALANCHE, SILVERADO, TAHOE, YUKON 4.3L, 5.3L 6.0L, 6 CIL y 8 CIL	99/07
---	-------

No. Original: 15778386



DEPÓSITOS ANTICONGELANTES / LIMPIA PARABRISAS Y TAPONES

GENERAL MOTORS

DEPÓSITOS ANTICONGELANTES



6712361

Ref.:712361
DEPÓSITO ANTICONGELANTE

CAVALIER Y PONTIAC SUNFIRE	95/05
MALIBU 2.2 y 2.4L	97/04
GRAND AM 2.4L	99/05

No. Original: 22712361

Depósito CON TAPÓN
6712361-T

Ref.:712361-T



6150751

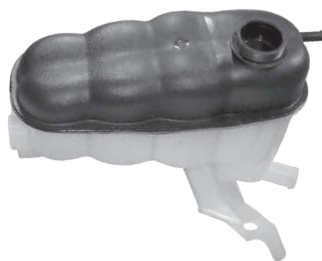

6797286

Ref.: 797286
DEPÓSITO ANTICONGELANTE

TAHOE, YUKON, AVALANCHE, SILVERADO, ESCALADE 4.3L, 4.8L, 5.3L y 6.0L	07/11
--	-------

No. Original: 22797286

Depósito CON TAPÓN
6797286-T

Ref.: 797286-T



6150751



6228531-1

DEPÓSITO ANTICONGELANTE

SUBURBAN, SILVERADO, TAHOE 5.3 & 6.0L	14/20
ESCALADE, YUKON 5.3 & 6.0L	14/20

No. Original: 22856231

Depósito CON TAPÓN
6228531-1-T



6150751



NUEVO

6228531

DEPÓSITO ANTICONGELANTE

SUBURBAN, SILVERADO, TAHOE 5.3 & 6.0L	14/20
ESCALADE, YUKON 5.3 & 6.0L	14/20

No. Original: 22856231

Depósito CON TAPÓN
6228531-1-T



6150751



6813425

Ref.: 813425
DEPÓSITO ANTICONGELANTE

OPTRA 2.0L, 4 CIL, 16 V	07/11
-------------------------	-------

No. Original: 96813425

Depósito CON TAPÓN
6813425-T

Ref.:813425-T



6220885



6813489

Ref.: 813489
DEPÓSITO ANTICONGELANTE

CAPTIVA 3.0L, 6 CIL	08/13
---------------------	-------

No. Original: 20813489

Depósito CON TAPÓN
6813489-T

Ref.:813489-T



6150751



6150751

Ref.: 150751

TAPÓN P/ DEPÓSITO ANTICONGELANTE

MALIBU 2.0L, 4 CIL	03/15
BUICK LACROSSE 2.4L, 4 CIL	10/13
BUICK REGAL 2.4L, 4 CIL	11/13
CADILLAC XTS 2.0L, 4 CIL (6132224)	2013
SILVERADO 2500/3500 6.6L V8	01/07
SIERRA 2500/3500 6.6L V8	01/07
AVALANCHE 6.6L 8 CIL (6158572)	03/07
CAVALIER Y PONTIAC SUNFIRE	95/05
MALIBU 2.2 y 2.4L	97/04
GRAND AM 2.4L (6712361)	99/05
CAPTIVA 3.0L, 6 CIL (6813489)	08/13
TAHOE, YUKON, AVALANCHE, SILVERADO, ESCALADE 4.3L, 4.8L, 5.3L y 6.0L (6797286)	07/11

No. Original: 15075118



6332652

Ref.: 332652

TAPÓN P/ DEPÓSITO ANTICONGELANTE

TORNADO 1.8L, 4 CIL	10/16
---------------------	-------

No. Original: 93326521

APLICA PARA: 6473615



6420303

Ref.: 420303

TAPÓN P/ DEPÓSITO ANTICONGELANTE

AVEO 4 CIL 1.6L (6521694)	09/13
MATIZ G1 y SPARK 1.0L 4 CIL (6562624)	03/05
MATIZ G2 y SPARK 1.0L 4 CIL (6591467)	06/10

No. Original: 96420303



6571316

TAPÓN P/ DEPÓSITO ANTICONGELANTE

CORVETTE 6 CIL 3.1L	84/96
CAVALIER 6 CIL 3.1L	95/05
MALIBU 6 CIL 3.1L (6677855)	99/05
SATURN SC, SL	92/02
SW 1.9L	93/01

No. Original: 25713160



671528

TAPÓN DE RADIADOR / 16LBS.

SEVILLE 4.6L, V8	98/99
BLAZER 3.1 y 4.3L, V6	96/05
S SERIES PICK-UP 2.2L, 4 CIL	95/97
S SERIES PICK-UP 4.3L, V6	95/97
S-10 2.2 y 4.3L, 4 CIL	96/99
GRAND AM 2.3 y 2.5L, 4 CIL	90/91
BLAZER 4.3L, V6 /GASOLINA	96/05



6352004

DEPÓSITO ANTICONGELANTE

SPARK 1.2L, 4 CIL	11/17
-------------------	-------

No. Original: 95352004

Depósito CON TAPÓN 6352004-T



6502353



6502353

TAPÓN P/ DEPÓSITO ANTICONGELANTE

SONIC 1.4L TURBO 1.6L, 4 CIL	11/17
SPARK 1.2L, 4 CIL	11/17
CRUZE 6 CIL	10/13
BUICK VERANO 6 CIL	12/13

No. Original: 13502353

APLICA PARA: 6352004, 6609220, 6132568



6530687

DEPÓSITO ANTICONGELANTE

ASTRA 2.4L, 4 CIL	04/06
ASTRA 1.8L, 4 CIL	00/01

No. Original: 90530687



DEPÓSITOS ANTICONGELANTES / LIMPIA PARABRISAS Y TAPONES

GENERAL MOTORS/ HONDA

DEPÓSITOS ANTICONGELANTES



6933363

DEPÓSITO ANTICONGELANTE

MERIVA L4 1.8L C/ 2 SALIDAS 03/UP

No. Original: 93336325

**Depósito CON TAPÓN
6933363-T**



6220885



6933977

DEPÓSITO ANTICONGELANTE

MERIVA L4 1.8L C/ 3 SALIDAS 03/UP

No. Original: 93397756

**Depósito CON TAPÓN
6933977-T**



6220885



6220885

Ref.: 220885

TAPÓN P/ DEPÓSITO ANTICONGELANTE

CORSA y TORNADO C/AIRE ACONDICIONADO (6367722)	06/08
CORSA y TORNADO S/AIRE ACONDICIONADO (6367723)	03/05
CHEVY (64150AM)	94/11
TAHOE, YUKON, AVALANCHE, SILVERADO, ESCALADE 4.3L, 4.8L, 5.3L y 6.0L (6797286)	07/11
OPTRA 4 CIL. 2.0L, 16V (6813425)	07/11
MERIVA L4 1.8L C/ 2 SALIDAS (6933363)	03/UP
MERIVA L4 1.8L C/ 3 SALIDAS (6933977)	03/UP
ASTRA 2.0L, 4 CIL (6905306)	04/06

No. Original: 93220885



6609220

DEPÓSITO ANTICONGELANTE

SONIC 1.4L TURBO 1.6L, 4 CIL 11/17

No. Original: 42609220

**Depósito CON TAPÓN
6609220-T**



6502353



6905306

DEPÓSITO ANTICONGELANTE

ASTRA 2.0L, 4 CIL 04/06

No. Original: 90530688

**Depósito CON TAPÓN
6905306-T**



6220885



NUEVO

6693016-1

DEPÓSITO ANTICONGELANTE

AVEO 1.5L, 4 CIL 18/21

No. Original: 26693016

**Depósito CON TAPÓN
6693016-1-T**



6502353



HONDA



91012A

DEPÓSITO ANT. CON TAPÓN

CIVIC 1.7L, 4 CIL	97/00
-------------------	-------

No. Original: 19101-P2A-000



91101R

DEPÓSITO ANT. CON TAPÓN

CITY 1.5L, 4 CIL	11/13
CR-Z 1.5L, 4 CIL	14/15
FIT 1.5L, 4 CIL	09/13
INSIGHT 1.3L, 4 CIL	10/13

No. Original: 19101-RB0-000



99104A

DEPÓSITO ANT. CON TAPÓN

ACCORD 2.4L, 4 & 6 CIL	08/12
CROSSTOUR 3.5L, 6 CIL	10/14
ELEMENT 2.4L, 4 CIL	03/10

No. Original: 19101-PZD-A00, 19101-PZD-A01, 19101-R40-A00

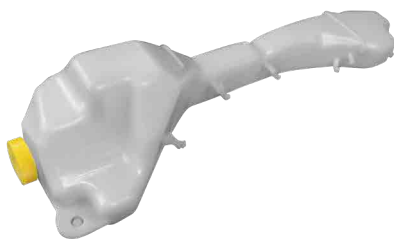

91910N

DEPÓSITO ANT. CON TAPÓN

Ref.:1910N

CRV 2.4L, 4 CIL	02/06
-----------------	-------

No. Original: 19101-PNB-000



91912M

DEPÓSITO ANT. CON TAPÓN

ACCORD 2.4L, 4 & 6 CIL	98/02
------------------------	-------

No. Original: 19101-PAA-A00, 19102-PM5-A00



913336

TAPÓN DE RADIADOR/ 16 LBS.

ACCORD 2.2L, 4 CIL	90/96
ACCORD 2.2L, 4 CIL	00/02
ACCORD 2.2L, 4 CIL	04
ACCORD 2.2L, 4 CIL	07
ACCORD 2.3L & 2.4L, 4 CIL / GASOLINA	90/96
ACCORD 2.3L & 2.4L, 4 CIL / GASOLINA	00/02
ACCORD 2.3L & 2.4L, 4 CIL / GASOLINA	04
ACCORD 2.3L & 2.4L, 4 CIL / GASOLINA	07
ACCORD 3.0L, V6/ GASOLINA	90/96
ACCORD 3.0L, V6/ GASOLINA	00/02
ACCORD 3.0L, V6/ GASOLINA	04
ACCORD 3.0L, V6/ GASOLINA	07



91910R

DEPÓSITO ANT. CON TAPÓN

ACCORD 2.4L, 4 CIL	03/07
--------------------	-------

No. Original: 19101-RAA-A00



99101C

Ref.:9101C
DEPÓSITO ANT. CON TAPÓN

CIVIC 1.7L, 4 CIL	01/05
-------------------	-------

No. Original: 19101-PLC-000



DEPÓSITOS ANTICONGELANTES / LIMPIA PARABRISAS Y TAPONES

HONDA/ HUMMER/ HYUNDAI

DEPÓSITOS ANTICONGELANTES



96802D

**DEPÓSITO LIMPIAPARABRISAS
CON TAPÓN**

ACCORD 2.4L, 4 CIL

03/07

No. Original: 76840-SDC-A02



918333

TAPÓN DE RADIADOR/ 13 LBS.

CIVIC 1.5L & 1.6L, 4 CIL

90/91



99100R

DEPÓSITO ANT. CON TAPÓN

ACCORD 2.4L, 4 CIL y 3.5L, V6
CROSSTOUR 2.4L, 4 CIL
CROSSTOUR 3.5L, V6

08/12
12/14
10/14

No. Original: 19101-R40A00

HUMMER



677528

TAPÓN DE RADIADOR/ 16 LBS

H1 6.6L, V8

06

HYUNDAI



93342AA

Ref.:3342AA

DEPÓSITO LIMPIA PARABRISAS

ATOS 1.0L, 4 CIL

01/11

No. Original: 05083342AA



96900AA

REF.: 6900AA

DEPÓSITO ANT. CON TAPÓN

ATOS 1.0L, 4 CIL

01/10

No. Original: 05069900AA



954310X-1

DEPÓSITO ANTICONGELANTE

I10 1.1L, 4 CIL

01/11

No. Original: 25431-0X000



925336

TAPÓN DE RADIADOR / 16 LBS.

ELANTRA 1.8L, 4 CIL/ GASOLINA
SONATA 2.4L, 4 CIL/ GASOLINA

13
13



9124000

REF.: 124000

TAPON DE GASOLINA / SIN LLAVE

ATOS 1.0L

01/11

No. Original: 31010-24000



ISUZU



930333

TAPÓN DE RADIADOR/ 13 LBS.

ELF 200 4JJ1-TC
ELF 300 4JJ1-TC

09/14
07/14

JAGUAR



424686

DEPÓSITO ANTICONGELANTE

JAGUAR X-TYPE 2.5L, 6 CIL

02/09

No. Original: C2S46861

**Depósito CON TAPÓN
424686 -T**



443821

**TAPÓN PARA DEPOSITO
ANTICONGELANTE**

JAGUAR X-TYPE 2.5L, 6 CIL
(424686)

02/09

No. Original: 1X438K218AG

KIA



907336

TAPÓN DE RADIADOR/ 16 LBS.

SORENTO 2.4L, 4 CIL/ GASOLINA
SPORTAGE 2.0L, 4 CIL/ GASOLINA

15
15

MAZDA

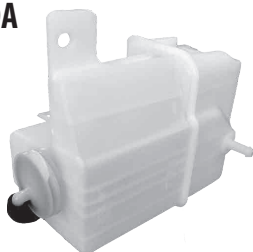

915350B

Ref.: 15350B

DEPÓSITO ANTICONGELANTE

PROTEGE 5 1.8L, 4 CIL

95/03

No. Original: B6BF15350B

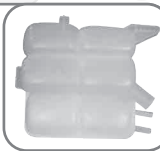

981535B

Ref.: 81535B

DEPÓSITO ANTICONGELANTE

MAZDA 3 2.0L y 2.5L, 4 CIL

06/13

No. Original: LF8B15350B

Depósito CON TAPÓN

981535B-T

Ref.: 81535B-T



7E88100



932115L

DEPÓSITO ANT. CON TAPÓN

MAZDA 6 1.8L, 4 CIL

03/06

No. Original: L32115350



DEPÓSITOS ANTICONGELANTES / LIMPIA PARABRISAS Y TAPONES

MAZDA/ MERCEDES BENZ/ MITSUBISHI

DEPÓSITOS ANTICONGELANTES



941350C

REF.: 41350C

DEPÓSITO ANT. CON TAPÓN

626 2.5L, 6 CIL

98/02

No. Original: KLG415350C



949336

TAPÓN DE RADIADOR/ 16 LBS.

626 2.0L, 4 CIL

CX-9 3.7L V6 /GASOLINA

MX-5 MIATA 2.0L, 4 CIL /GASOLINA

93/97

09/11

06/07

MERCEDES BENZ



469550

TAPÓN DE RADIADOR

1215/ 1218/ 1318/ 1418/ 1420/1620/

1634/ 1718/ 1720/ 193/1938/2238/

2420/ 709/ 710/ 712/ 914/ M2000/

O500/OF1417/ OF1428/ OF1721/

OF1722/ OH1417/ OH1418/ OH1421/

OH1621

MITSUBISHI



959735

DEPÓSITO ANT. CON TAPÓN

ECLIPSE 2.4L, 4 CIL

ENDEAVOR 3.8L, 4 CIL

GALANT 2.4L, 4 CIL

06/12

04/08

04/08

No. Original: MR597325



945023

DEPÓSITO ANT. CON TAPÓN

LANCER 1.6L, 4 CIL

04/06

No. Original: MR450237



964333

TAPÓN DE RADIADOR / 13 LBS.

GALANT 2.0L, 4 CIL

PICK-UP 2.0L & 2.4L, 4CIL

90/93

87/96



961336

TAPÓN DE RADIADOR/ 16 LBS.

LANCER 2.0 y 2.4L 4 CIL/ GASOLINA

MONTERO 3.8L V6/ GASOLINA

OUTLANDER 2.4L, 4 CIL/ GASOLINA

OUTLANDER 3.0L, V6/ GASOLINA

03/11

04/06

04/11

04/11



966527

TAPÓN DE RADIADOR/ 13 LBS.

PICK-UP 2.0L, 4 CIL

83/86



917040

DEPÓSITO ANT. CON TAPÓN

PATHFINDER 3.5L, 6 CIL

INFINITI QX4 3.5L, 6 CIL

99/04

01/03

No. Original: 21710-4W000,
21710-4W00A



NISSAN

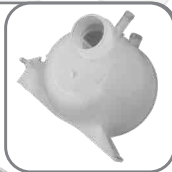

9000QAA

Ref.: 000QAA

DEPÓSITO ANTICONGELANTE

PLATINA 1.6L, 4 CIL
RENAULT CLIO 1.6 y 2.0L

TODOS

No. Original: 21710-00QAA

Depósito CON TAPÓN

9000QAA-T

Ref.:000QAA-T



9215160



910610

Ref: 10610

DEPÓSITO ANT. CON TAPÓN

SENTRA B15 1.8 y 2.0L, 4 CIL

01/06

No. Original: 21710-6M100

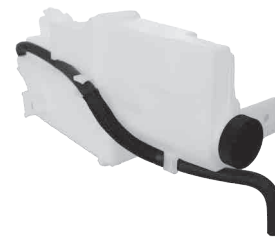

917101

DEPÓSITO ANT. CON TAPÓN

VERSA 1.6L, 4 CIL

12/UP

No. Original: 21710-1HS3A



917102

DEPÓSITO ANT. CON TAPÓN

MAXIMA 3.0L, 6 CIL

INFINITI I30 3.0L, 6 CIL

INFINITI I35 3.5L, 6 CIL

99/08

00/01

02/04

No. Original: 21710-2Y000,
21710-2Y00A



921710

DEPÓSITO ANT. CON TAPÓN

REF.: 21710

TSURU III

SENTRA

TSUBAME

92/09

96/00

TODAS

No. Original: 21710-F4300



921718

Ref.: 21718

DEPÓSITO ANT. CON TAPÓN

ALTIMA, MAXIMA 2.5L, 6 CIL

02/07

No. Original: 21710-8J000



927100-1

DEPÓSITO ANT. CON TAPÓN

TIIDA SEDAN 1.6L y 1.8L, 4 CIL

07/16

No. Original: 21710-ED000

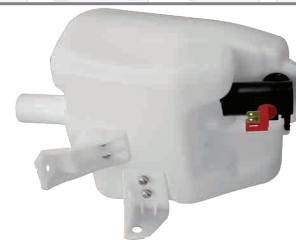

928910

Ref.: 28910

DEPÓSITO LIMPIA PARABRISAS

TSURU III

SENTRA

TSUBAME

92/09

96/00

TODAS

No. Original: 28910-F4300



DEPÓSITOS ANTICONGELANTES / LIMPIA PARABRISAS Y TAPONES

NISSAN

DEPÓSITOS ANTICONGELANTES



971001

Ref.: 71001

DEPÓSITO ANT. CON TAPÓN

URVAN 2.5L, 4 CIL

05/13

No. Original: 21710-VW010



971020

Ref.: 71020

DEPÓSITO ANT. CON TAPÓN

NP300 CHASIS

NP300 DOBLE CABINA

NP300 ESTACAS 720

NP300 PICK-UP

D22 2.4L, 4 CIL

07/14

07/14

07/14

08/12

No. Original: 21710-VN20A



971250

Ref.: 71250

DEPÓSITO ANT. CON TAPÓN

TSURU II y III 4 CIL

92/UP

No. Original: 21712-50M01

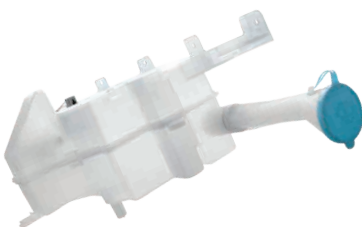

991084

REF.: 91084

DEPÓSITO LIMPIAPARABRISAS C/ TAPÓN

ALTIMA, MAXIMA 2.5L, 6 CIL

02/06

No. Original: 28910-8J400



9F4020

Ref.: F4020

DEPÓSITO ANT. CON TAPÓN

D21 2.4 L, 4 CIL

98/UP

No. Original: 21710-F4020



991003

Ref.: 91003

DEPÓSITO LIMPIA PARABRISAS

D21 2.4L, 4 CIL

94/07

No. Original: 28910-G03G0



9DDH180

Ref.: DDH180

DEPÓSITO DE DIRECCIÓN CON TAPÓN

D21

TODOS

No. Original: 49180-8B410



9ZG00A

Ref.: ZG00A

DEPÓSITO LIMPIAPARABRISAS C/ TAPÓN

SENTRA

01/06

No. Original: 28910-ZG00A



921712F

Ref.: 21712F

TAPÓN P/ DEPÓSITO ANTICONGELANTE

TSURU III B13,

SENTRA B14

TSUBAME (921710)

NISSAN D21 2.4L, 4 CIL (9F4020)

URVAN 2.5L, 4 CIL (971001)

92/09

96/00

TODOS

98/UP

00/10

No. Original: 21712-F4100



921430F

REF.:21430F

TAPÓN DE RADIADOR / 09 LBS.

TSURU III B13

93/07

No. Original: 21430-F430A



9215160

TAPÓN P/ DEPÓSITO ANTICONGELANTE

Ref.: 215160

PLATINA (9000QAA)

MEGANE I 2.0L, 4 CIL

SCENIC I 2.0L, 4 CIL (468746)

(ENCENDIDO CON LLAVE)

CHEROKEE 4.0L, 6 CIL (5773849)

TODOS

01/04

01/04

87/96

No. Original: 21516-00QAB



956333

TAPÓN DE RADIADOR / 13 LBS.

350Z 3.5L, V6/ GASOLINA

03

ALTIMA 2.4L y 2.5L, 4 CIL, 3.5L, V6/ GASOLINA

93/06

FRONTIER 2.4L, 4 CIL, 2.3L, V6/GASOLINA

99/04

JUKE 1.6L, 4 CIL/ GASOLINA

12/15

MARCH 1.6L, 4 CIL/ GASOLINA

11/15

MAXIMA 3.0L y 3.5L, V6/ GASOLINA

85/86

MAXIMA 3.0L y 3.5L, V6/ GASOLINA

90/07

MURANO 3.5L, 6 CIL, V6/GASOLINA

04/07

PATHFINDER 3.3L y 3.5L V6/ GASOLINA

90/04

QUEST 3.3L Y 3.5L V6/GASOLINA

93/07

SENTRA 1.6 L,1.8L, 2.0L y 2.5L, 4 CIL /

90/15

GASOLINA

TIIDA 1.8L, 4 CIL/GASOLINA

07/12

TSURU 1.6L, 4 CIL/ GASOLINA

01/15

URVAN 2.5L, 4 CIL/ GASOLINA

09/12

URVAN 3.0L, 4 CIL/ DIESEL

09/12

VERSA 1.6L, 4 CIL/GASOLINA

12/15

X-TERRA 2.4L, 4 CIL, 3.3L V6/ GASOLINA

00/04

CABSTAR NISSAN /DIESEL y D25DDTi

08/13

240SX 2.4L, 4 CIL

91/98

300ZX 3.0L, V6

94/96

ALTIMA 2.4L, 4 CIL

93/06

ALTIMA 3.5L, V6

93/06

ESTAQUITAS 1.8L y 2.4L, 4 CIL

85/96

FRONTIER 2.4L, 4 CIL

99/04

FRONTIER 3.3L, V6

99/04

ICHI VAN 1.8 L y 2.4L, 4 CIL

85/96

MAXIMA 3.0L y 3.5L V6

85/86

MAXIMA 3.0L y 3.5L V6

90/07

PATHFINDER V6, 3.0L, 3.3L y 3.5L

90/04

PICK-UP 2.4L, 4 CIL

85/97

QUEST V6, 3.0L y 3.3L

93/02

QUEST V6, 3.0L y 3.3L

04/07

SENTRA 1.6L,1.8L y 2.0L, 4 CIL

90/15

INFINITI I30 3.0L, V6/ GASOLINA

98/01

INFINITI Q45 4.5L, V8/ GASOLINA

03



958527

TAPÓN DE RADIADOR/ 13 LBS.

PICK-UP 2.4L, 4 CIL

83/86



953336

TAPÓN DE RADIADOR/16 LBS.

INFINITI Q45 4.1L V8

99

INFINITI Q45 4.1L V8

01

300ZX 3.0L V6

90/93

FRONTIER 2.5L, 4 CIL/ GASOLINA

05/09

FRONTIER 4.0L, V6/ GASOLINA

05/09

PATHFINDER 4.0L, V6/ GASOLINA

05/07

PICK-UP 2.4L, 4 CIL/ GASOLINA

00/07

X-TERRA 4.0L, V6/GASOLINA

05/07



917341

ROSCA Y EMPAQUE PARA BOMBA DE GASOLINA

CLIO y PLATINA 1.6L, 4 CIL

06/10

No. Original: 17341-00QAC

**NÚMEROS QUE APLICAN PARA NISSAN Y RENAULT:
9215160, 9000QAA,
9000QAA-T**



DEPÓSITOS ANTICONGELANTES / LIMPIA PARABRISAS Y TAPONES

RENAULT/ SUBARU/ SUZUKI/ TOYOTA

DEPÓSITOS ANTICONGELANTES



9214303

TAPÓN P/ DEPÓSITO ANTICONGELANTE

PLATINA (9000QAA) MEGANE II 2.0L, 4 CIL SCENIC II 2.0L, 4 CIL (ENCENDIDO CON TARJETA) (477499)	TODOS 05/09 04/06
---	-------------------------

No. Original: 21430-AX300

SUBARU



905336

TAPÓN DE RADIADOR/ 16 LBS.

FORESTER 2.5L, 4 CIL/ GASOLINA IMPREZA 2.5L, 4 CIL/ GASOLINA LEGACY 2.5L, 4 CIL/ GASOLINA OUTBACK 2.5L, 4 CIL/ GASOLINA	06/07 06/07 06/07 06/07
--	----------------------------------

SUZUKI



988333

TAPÓN DE RADIADOR/ 13 LBS.

SAMURAI 1.3L, 4 CIL SIDEKICK 1.6L, 4 CIL	90/95 90/91
---	----------------

RENAULT

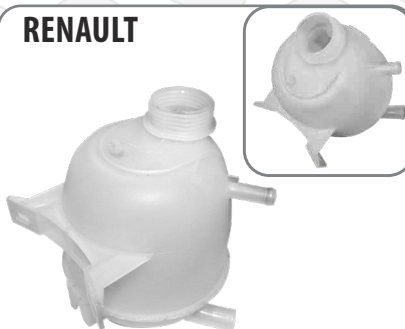

468746

Ref.:68746

DEPÓSITO ANTICONGELANTE

MEGANE I 2.0L, 4 CIL SCENIC I 2.0L, 4 CIL (ENCENDIDO CON LLAVE)	01/04 01/04
---	----------------

No. Original: 7701468746, 7701468745

**Depósito CON TAPÓN
468746-T**

Ref.:68746-T



9215160



477499

Ref.: 77499

DEPÓSITO ANTICONGELANTE

MEGANE II 2.0L, 4 CIL SCENIC II 2.0L, 4 CIL (ENCENDIDO CON TARJETA)	05/09 04/06
---	----------------

No. Original: 7701474499, 8200273157

**Depósito CON TAPÓN
477499-T**



9214303

TOYOTA



912353

DEPÓSITO ANT. CON TAPÓN

COROLLA 1.8L, 4 CIL	98/02
---------------------	-------

No. Original: 85315-02030,
85316-01011



916711

Ref.:16711
DEPÓSITO ANTICONGELANTE

TACOMA 4.0L, 6 CIL

05/10

No. Original: 16711-0P020



916405

DEPÓSITO ANT. CON TAPÓN

TACOMA 4.0L, 6 CIL
HI-LUX 2.5L, 4 CIL

95/04
04/12

No. Original: 16405-0C010
16470-0C011



975121

DEPÓSITO ANTICONGELANTE

Ref.: 75121

HIACE 2.4L, 4 CIL

05/11

No. Original: 16470-75121



964210

DEPÓSITO ANT. CON TAPÓN

HIGHLANDER 2.4L, 4 CIL

01/07

No. Original: 16470-20100



964720

DEPÓSITO ANT. CON TAPÓN

CAMRY 2.4L, 4 CIL

07/11

No. Original: 16470-0P020



916714

DEPÓSITO ANTICONGELANTE

TACOMA 4.0L, 6CIL

05/UP

No. Original: 16711-0C140

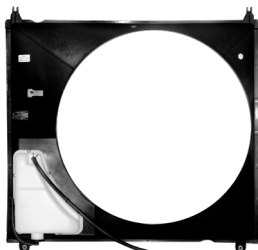

916710

DEPÓSITO ANTICONGELANTE

TUNDRA 4.5L, 8 CIL

07/UP

No. Original: 16711-0P100

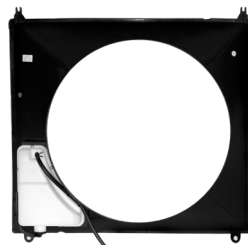

916715

DEPÓSITO ANTICONGELANTE

SEQUOIA 4.7L, 8 CIL

08/09

No. Original: 16711-0F050



970333

TAPÓN DE RADIADOR/ 13 LBS.

4 RUNNER 2.4L, 4 CIL
CAMRY 2.0L, 4 CIL
CAMRY 2.5L, V6,
CORSIKA 1.6L, 4 CIL
TERCEL 1.5L, 4 CIL

86/95
90/91
90/91
90/93
90



DEPÓSITOS ANTICONGELANTES / LIMPIA PARABRISAS Y TAPONES

TOYOTA / UNIVERSAL / VOLKSWAGEN

DEPÓSITOS ANTICONGELANTES



979336

TAPÓN DE RADIADOR/ 16 LBS.

CAMRY 3.0L, V6	94/97
CAMRY 3.0L, V6	01/06
LAND CRUISER 4.7L, V8/ GASOLINA	03/07
SIENNA 3.0L, V6/ GASOLINA	03/06
SOLARA 3.3L, V6/ GASOLINA	05/06



970527

TAPÓN DE RADIADOR/ 13 LBS.

4 RUNNER 2.4L, 4 CIL	85
----------------------	----

UNIVERSAL



145679

DEPÓSITO ANT. CON TAPÓN

UNIVERSAL	TODOS
-----------	-------

VOLKSWAGEN



1121403

Ref.: 121403
DEPÓSITO ANTICONGELANTE

COMBI 1800 1,8L ENFRIADO POR AGUA SUPERIOR	92/02
---	-------

No. Original: 025-121-403-B

Depósito CON TAPÓN
1121403-T
Ref.:121403-T



1121321



1121407

Ref.: 121407
DEPÓSITO ANTICONGELANTE

POLO, CÓRDOBA, IBIZA 1.6L, 4 CIL VENTO 1.6L, 4 CIL	00/09 15/UP
---	----------------

No. Original: 6Q0-121-407,
6Q0-121-407-B

Depósito CON TAPÓN
1121407-T
Ref.:121407-T



121321B



121403B

Ref.: 21403B
DEPÓSITO ANTICONGELANTE

AUDI A3 GOLF y JETTA A4 SEAT LEÓN	97/03 99/06 01/06
---	-------------------------

No. Original: 1J0-121-403-B

Depósito CON TAPÓN
121403B-T
Ref.:21403B-T



121321B



121403L

Ref.: 21403L

DEPÓSITO ANTICONGELANTE

AUDI A4 1.8L, 4 CIL
A6 2.5 y 2.8L
PASSAT 2.8L, V6

98/02

96/02

No. Original: 8D0-121-403-L

**Depósito CON TAPÓN
121403L-T**

Ref.:21403L-T



121321B



121407A

Ref.: 21407A

**DEPÓSITO ANTICONGELANTE
CON SENSOR**

GOLF y JETTA A2-A3
POINTER 1.8L, 4 CIL
PASSAT y POLO

88/99
00/08

No. Original: 1H0-121-407-A

**Depósito CON TAPÓN
121407A-T**

Ref.:21407A-T



121321C



121407C

Ref.: 21407C

DEPÓSITO ANTICONGELANTE

EUROVAN T4 2.5L

00/04

No. Original: 707-721-407-C

**Depósito CON TAPÓN
121407C-T**

Ref.:21407C-T



121321C



121407E

Ref.: 21407E

DEPÓSITO ANTICONGELANTE

POINTER A1 1.8L, 4 CIL
CARIBE y ATLANTIC 1.8L, 4 CIL
GOLF y PASSAT

97/99
77/87

No. Original: 171-121-407-E

**Depósito CON TAPÓN
121407E-T**

Ref.:21407E-T



1312132



121407K

Ref.: 21407K

DEPÓSITO ANTICONGELANTE

BORA, GOLF GTI 1.8L, 4 CIL
PASSAT y A3
JETTA 2.5L
JETTA A4 2.5L, 5 CIL
LEÓN y TOLEDO

05/09
05/Up
06/10
06/10

No. Original: 1K0-121-407-A

**Depósito CON TAPÓN
121407K-T**

Ref.:21407K-T



121321B



1501247

DEPÓSITO ANTICONGELANTE

GOL SAVEIRO 1.6L, 4 CIL

01/06

No. Original: 5U0-121-407

**Depósito CON TAPÓN
1501247-T**



1201213



DEPÓSITOS ANTICONGELANTES / LIMPIA PARABRISAS Y TAPONES

VOLKSWAGEN

DEPÓSITOS ANTICONGELANTES



1512140

Ref.:512140
DEPÓSITO ANTICONGELANTE

COMBI 1800 1,8L 92/02
ENFRIADO POR AGUA INFERIOR

No. Original: 025-121-403

Depósito CON TAPÓN
1512140-T

Ref.:512140-T



1121482



1521407

Ref.:521407
DEPÓSITO ANTICONGELANTE

LUPO, CROSS FOX 1.6L, 4 CIL 03/08

No. Original: 5Z0-121-407

Depósito CON TAPÓN
1521407-T

Ref.:521407-T



121321B



1701214-1

DEPÓSITO ANTICONGELANTE

EUROVAN T5 1.9L, 4 CIL 05/UP
TRANSPORTER 2.0L, 4 CIL

No. Original: 7H0-121-407-C

Depósito CON TAPÓN
1701214-T-1



1201213



1201213

TAPON PARA DEP. ANTICONGELANTE

GOL SAVEIRO 1.6L, 4 CIL TODOS

No. Original: 2Q0-121-321

APLICA PARA: 1501247, 1701214-1



1775-1AM

Ref.: 755-1AM
DEPÓSITO LIMPIAPARABRISAS C/ TAPÓN

JETTA A4 2.0L 4 CIL 99/07

No. Original: 1J0-955-453-P



122371D

Ref.: 22371D
DEP. LÍQUIDO DIRECCIÓN HIDRÁULICA

GOLF JETTA A2 1.8L, 4 CIL 87/92

No. Original: 191-422-371-D



HUECO

1DDH371

Ref.: DDH371

DEP. LÍQUIDO DIRECCIÓN HIDRÁULICA

POLO, IBIZA, CORDOBA 1.4L, 4 CIL	03/07
PARA ABRAZADERA CON TAPÓN	

No. Original: 6Q0-423-371

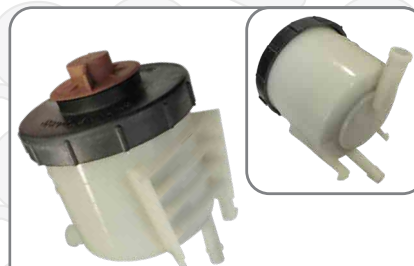

1DDH711

Ref.: DDH711

DEP. LÍQUIDO DIRECCIÓN HIDRÁULICA

POINTER-CORSAR 1.8L, 4 CIL	94/10
----------------------------	-------

No. Original: 325-422-371-1



1DDH71A

DEP. LÍQUIDO DIRECCIÓN HIDRÁULICA

POLO IBIZA CORDOBA 1.4L, 4 CIL	03/08
P/TORNILLOS	

No. Original: 6Q0-423-371-A



1DDH71B

Ref.: DDH71B

DEP. LÍQUIDO DIRECCIÓN HIDRÁULICA

EUROVAN T4 2.5L	00/04
-----------------	-------

No. Original: 701-422-371-B



1DDH71C

Ref.: DDH71C

DEP. LÍQUIDO DIRECCIÓN HIDRÁULICA

GOLF/ JETTA A4 2.0L, 4 CIL	99/06
GOL LEON 2.0L, 4 CIL	02/06

No. Original: 1J0-422-371-C



1DDH71D

Ref.: DDH71D

DEP. LÍQUIDO DIRECCIÓN HIDRÁULICA

A3-DERBY 1.8L, 4 CIL	93/99
----------------------	-------

No. Original: 1H0-422-371-D



1121321

Ref.: 121321

TAPÓN P/ DEPÓSITO ANTICONGELANTE

COMBI 1800 1.8L (ENFRIADO POR AGUA SUPERIOR) (1121403)	92/02
GOLF GTI 1.8L 4 CIL	88/92

No. Original: 025-121-321-B



1121482

Ref.: 121482

TAPÓN P/ DEPÓSITO ANTICONGELANTE

T2A COMBI 1800 1.8L (ENFRIADA POR AGUA) INFERIOR (1512140)	92/02
--	-------

No. Original: 025-121-482



113485A

Ref.: 13485A

TAPÓN DE ACEITE

CARIBE ATLANTIC A1, GOLF, JETTA A2 A3	87/92
DERBY	93/99
	95/97

No. Original: 026-103-485-A



DEPÓSITOS ANTICONGELANTES / LIMPIA PARABRISAS Y TAPONES

VOLKSWAGEN

DEPÓSITOS ANTICONGELANTES



121321B

Ref.: 21321B

TAPÓN P/ DEPÓSITO ANTICONGELANTE

AUDI A4 1.8L 4 CIL, A6 2.5 y 2.8L	98/02
PASSAT 2.8L V6 (121403L)	96/02
GOLF y JETTA A4	99/06
AUDI A3	97/03
SEAT LEÓN (121403B)	01/06
POLO, CORDOBA E IBIZA 1.6L, 4 CIL (121407)	00/09
BORA, GOLF GTI 1.8L 4CIL.	05/09
PASSAT y A3	05/UP
JETTA 2.5L	06/10
JETTA A4 2.5L, 5 CIL.	06/10
LEÓN y TOLEDO (121407K)	
LUPO, CROSS FOX 1.6L, 4 CIL (1521407)	03/08

No. Original: 1J0-121-321-B



121321C

Ref.:21321C

TAPÓN P/ DEPÓSITO ANTICONGELANTE

GOLF y JETTA A2-A3	88/99
POINTER 1.8L, 4CIL.	00/08
PASSAT y POLO (121407A)	
EUROVAN T4 2.5L (121407C)	00/04

No. Original: 357-121-321-C



1312132

Ref.:312132

TAPÓN P/ DEPÓSITO ANTICONGELANTE

POINTER A1 1.8L, 4 CIL	97/99
CARIBE y ATLÁNTIC 1.8L, 4CIL.	77/87
GOLF y PASSAT (121407E)	

No. Original: 443-121-321

APLICA PARA: 121407E



121553B

Ref.: 21553B

TAPÓN DE GASOLINA

A3 DERBY	95/02
NB	98/01
POLO, LUPO, AUDI-A3	97/00
AUDI A4 SIN LLAVE	95/01

No. Original: 1H0-201-553-B



FREIGHTLINER

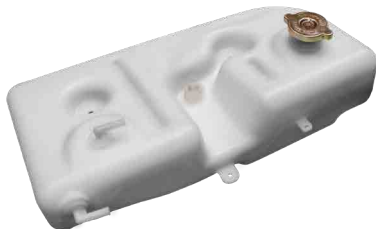

905

DEPÓSITO ANT. CON TAPÓN

FLD120, FLD120 SD FLD132	02/04 03/04
-----------------------------	----------------

No. Original: A0523574000, A0519234000



907

DEPÓSITO ANT. CON TAPÓN

CASCADIA, M2 112 CORONADO COLUMBIA CENTURY CLASS	08/19 18/19 10/15 08/11
---	----------------------------------

No. Original: A0525263007,
A0525263006, A0525263005



914

DEPÓSITO ANT. CON TAPÓN

M2 106, M2 112 BUSINESS CLASS M2 M2	08/14 08/12 08/09
---	-------------------------

No. Original: A1414796003, A1419133000



922

DEPÓSITO ANTICONGELANTE

M2 106, M2 112 M2 M2 100	04/10 04/09 04/06
--------------------------------	-------------------------

No. Original: A2262487000, A2258778000



930

DEPÓSITO ANT. CON TAPÓN

FLD120, FLD120SD, FLD132	05/07
--------------------------	-------

No. Original: EX03AC00019SP



945

DEPÓSITO ANTICONGELANTE

CENTURY CENTURY CST 112 CENTURY CST 120 COLUMBIA COLUMBIA 112 COLUMBIA 120	04/09 04/05 04/09 04/09 04/08 04/09
---	--

No. Original: 05-23045-000,
05-23045-001, 05-20529-000



952

DEPÓSITO ANT. CON TAPÓN

M2 106 BUSINESS CLASS M2	12/19 2012
-----------------------------	---------------

No. Original: A0528531002,
A0528531001, A0528531000

DEPÓSITOS ANTICONGELANTES / LIMPIA PARABRISAS EQUIPO PESADO

GMC/HINO

DEPÓSITOS ANTICONGELANTES



978

DEPÓSITO ANTICONGELANTE

FREIGHTLINER M2	05/10
FREIGHTLINER M2 106	05/10
FREIGHTLINER M2 112	09/10
THOMAS C2	05/10
THOMAS SAF-T LINER C2	05/10

No. Original: 05-21178-000
05-23195-000



995

DEPÓSITO ANTICONGELANTE

TRACTO NUEVO CASCADIA 10/UP

No. Original: A22-60952-004

GMC



968

DEPÓSITO ANTICONGELANTE

C6500/C7500 KODIAK, TOPKICK V8 366 6.0L & V8 427 7.0L	97/98
C60/C70 KODIAK V8 366 6.0L & V8 427 7.0L	90/96
C6000/C7000 TOPKICK V8 366 6.0L & V8 427 7.0L	90/96
C5500/C5000 KODIAK V8 366 6.0L	90/91

No. Original: 15688604



985

DEPÓSITO ANTICONGELANTE

W3500 TILTMASER, W4500 TILTMASER, W3500 FORWARD, W4500 FORWARD,	95/07
W5500 TILTMASER, W5500 FORWARD W5500HD TILTMASER, W5500HD FORWARD	99/07 05/07

No. Original: 897855656



989

DEPÓSITO ANT. CON TAPÓN

W5500HD FORWARD, TILTMASER W3500/W4500/W5500 FORWARD, TILTMASER	05/07 99/07
---	----------------

No. Original: 8975530122

HINO



910

DEPÓSITO LIMPIA-PARABRISAS CON TAPÓN

145, 165, 185, 238, 268, 338, DUTRO, FD 258LP	05/10 06/10
258ALP, 268A, 338CT, 358 308	08/10 2007

No. Original: 85310E0020

DEPÓSITOS ANTICONGELANTES / LIMPIA PARABRISAS EQUIPO PESADO

HINO/ IC CORPORATION/ INTERNATIONAL



DEPÓSITOS ANTICONGELANTES



947

DEPÓSITO ANTICONGELANTE

145, 165, 185, 238, 268, 338, DUTRO, FD 258LP	05/10
258ALP, 268A, 338CT, 358	06/10
308	08/10
	2007

No. Original: 16470E0030

IC CORPORATION



926

DEPÓSITO ANTICONGELANTE

1300 FBC, CE COMMERCIAL/ INTEGRATED/SCHOOL BUS	06/15
FE COMMERCIAL	08/12
FE SCHOOL BUS	07/11
FE INTEGRATED	07/08

No. Original: 2602943C91, 2602872C91,
2599039C91, 2591625C92



935

DEPÓSITO ANT. CON TAPÓN

FE SCHOOL BUS	02/04
CE SCHOOL BUS, FE COMMERCIAL, RE SCHOOL BUS	03/04
CE COMMERCIAL, RE COMMERCIAL	03/05
3000 IC	2004
3000/3300 CHASSIS, CE/FE/RE INTEGRATED	2005

No. Original: 3578833C3, 4C4Z8B379A,
2602935C91, BC4Z8A080A, 2587324C1,
2039390C3

INTERNATIONAL



900

DEPÓSITO ANT. CON TAPÓN

9200	03/08
5900	03/09
9900I	03/17
PROSTAR	07/18

No. Original:



903

**DEPÓSITO LIMPIA-PARABRISAS
CON TAPÓN**

3000	97/02
4700LP/4700LPX/4800/4900	97/03
4700	97/05
3000RE	2005
3200	03/07
3300	05/07

No. Original: 2033902C92, 2033902C91,
2033903C92



921

DEPÓSITO ANT. CON TAPÓN

4700 & 4900 4.8L, 4 CIL	89/02
-------------------------	-------

No. Original: 5C4Z8A080AA,
2002105C2, 2002105C3



DEPÓSITOS ANTICONGELANTES / LIMPIA PARABRISAS EQUIPO PESADO

INTERNATIONAL / ISUZU

DEPÓSITOS ANTICONGELANTES



925

DEPÓSITO ANT. CON TAPÓN

7300/7400/7500/CXT	01/11
MXT	05/09
7300 SFA	07/11
7300 SBA	08/11

No. Original: 2587216C1, 2591802C1



926

DEPÓSITO ANTICONGELANTE

4300, 4300LP, 4400, 4400LP	06/15
3200, 8500	06/11
CXT	06/08
3300, RXT	06/07

No. Original: 2602943C91, 2602872C91, 2599039C91, 2591625C92



935

DEPÓSITO ANT. CON TAPÓN

2574, 2674, 4800, 8000, 8100	02/03
3800, 4700	02/04
4300, 4300LP, 4400, 4400LP, 4900,	02/05
5500I, 5600I, 7300, 7400, 7500,	
8500, 3200	
3000RE, CXT	2005

No. Original: 3578833C3, 4C4Z88379A, 2602935C91, BC4Z8A080A, 2587324C1, 2039390C3



940

DEPÓSITO LÍQUIDO DIRECCIÓN HIDRÁULICA

4300, 4300LP	14/16
4400, 4400LP	12/16
5500I, 5900I, 5900I SBA, 7300, 7300 SFA,	08/10
7400, 7500, 8600, 8600 TRANSTAR, 9900I,	
9900IX, CXT	
9400, 9400I SBA	08/09
5500I, 5600I, 5900I, 5900I SBA	03/07
7300, 7400, 7500, CXT	02/07
7300 SFA	2007
7600, 8600, 8600 SBA, 9200I SBA, 9400,	03/07
9400I SBA, 9900I, 9900IX	
7700	05/07
9900I SFA, 9900IX SFA	2003

No. Original: 4043516C91, 3558153C93, 3558303C4, 3558153C94, 3569593C93



970

DEPÓSITO ANT. CON TAPÓN

TRACTOCAMIÓN 9200 y 9400	2004
11.0L, 6 CIL	

No. Original: 2508700C91, 2508700C92, 2508700C93, 3565217F93

ISUZU



6516167

DEPÓSITO ANTICONGELANTE

HTR, HVR	05/08
----------	-------

No. Original: 15161670

DEPÓSITOS ANTICONGELANTES / LIMPIA PARABRISAS EQUIPO PESADO

ISUZU/ KENWORTH/ MACK



DEPÓSITOS ANTICONGELANTES



985

DEPÓSITO ANTICONGELANTE

NPR	95/07
NPR-HD, NQR	99/07
NRR	05/07

No. Original: 897855656



989

DEPÓSITO ANTICONGELANTE

NPR/NPR-HD/NQR	99/07
NRR	05/07

No. Original: 8975530122

KENWORTH



920

DEPÓSITO ANT. CON TAPÓN

T600 & T800	TODOS
MOTOR CUMMINS ISX 6 CIL	
T300 MOTOR CUMMINS ISX 6 CIL	99/02

No. Original: K114-20



953

DEPÓSITO ANTICONGELANTE

T600	08/15
T660	08/17
T800, W900	08/18

No. Original: N5346001



955

DEPÓSITO ANTICONGELANTE

T680	13/16
------	-------

No. Original: N5355001

MACK

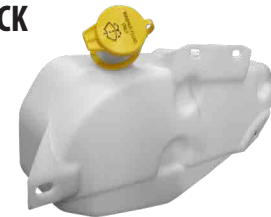

928

DEPÓSITO LIMPIA-PARABRISAS

MR600K	02/03
MR600P	01/03
MR	97/00
MR600P	91/96

No. Original: 25128217



943

DEPÓSITO LIMPIA-PARABRISAS

RD	87/02
----	-------

No. Original: 25128543



951

DEPÓSITO LIMPIA-PARABRISAS

GU7, GU8	2008
CV	04/07

NO PRESURIZADO

No. Original: 25133601



976

DEPÓSITO ANTICONGELANTE

GU7, GU8	2008
CV	04/07

PRESURIZADO

No. Original: 76MF520M, 25174629

DEPÓSITOS ANTICONGELANTES / LIMPIA PARABRISAS EQUIPO PESADO

MACK/ MERCEDES B./ PETERBILT / STERLING TRUCK

DEPÓSITOS ANTICONGELANTES



997

DEPÓSITO ANTICONGELANTE

CHU, CXU	08/18
CXN	2008
PINNACLE	08/15

No. Original: 21846997, 22061290, 20968795, 21074569, 21000194, 21074555, 22564837, 21314361, 21067134, 21513975, 21038101

MERCEDES BENZ



469550

TAPÓN DE RADIADOR

1215/ 1218/ 1318/ 1418/ 1420/1620/
1634/ 1718/ 1720/ 193/1938/2238/
2420/ 709/ 710/ 712/ 914/ M2000/
O500/OF1417/ OF1428/ OF1721/
OF1722/ OH1417/ OH1418/ OH1421/
OH1621

PETERBILT



953

DEPÓSITO ANTICONGELANTE

377, 385	08/14
388	08/15
384, 386	08/16
382	08/17
365, 367	08/18
389	08/19
348	10/18

No. Original: N5346001



955

DEPÓSITO ANTICONGELANTE

335 CATERPILLAR, 378 CATERPILLAR,	06/07
378 CUMMINS, 385 CATERPILLAR	
335/385 CUMMINS	06/08
320 CATERPILLAR	06/09
387 CATERPILLAR & CUMMINS	06/11
386 CATERPILLAR	06/12
320/382 CUMMINS	06/15
340 CUMMINS	07/08
365/367/384/388 CATERPILLAR	07/11
365/367/384/386/388/389 CUMMINS	07/15
362	2006
330 CATERPILLAR, 330 CUMMINS,	2007
340 CATERPILLAR, 389 CATERPILLAR	
357 CATERPILLAR & CUMMINS	2008

No. Original: N5355001



986

DEPÓSITO LIMPIA-PARABRISAS

357, 377, 379	89/07
375	89/00

No. Original: R866001

STERLING TRUCK



942

DEPÓSITO ANTICONGELANTE

A9500, AT9500, L8500, LT8500, L9500, LT9500	99/04
LT9513	99/02
A9513, AT9513, L8513, LT8513, L9511, LT9511,	99/01
LT8511, LT9501, LT9522	
AT9522, L8511, L9501, L9513	99/00
A9522, L8501, L9522, LT8501	1999

No. Original: A523573000, 24224219



VOLVO



901

DEPÓSITO LIMPIA-PARABRISAS

VNL	97/15
VN	01/14

No. Original: 21067134, 21038101, 21314361, 21000194, 82711780, 82714827, 21846997, 22061290, 82711782, 21074569, 20968795, 21074555



939

DEPÓSITO ANTICONGELANTE

WG	96/00
WI	90/98
WC, WH, WX	90/94

No. Original: 3966106, 212073202, 212013201, 212013202, 212073201, 3966107



984

DEPÓSITO ANTICONGELANTE

VN, VNL, VNM	98/03
--------------	-------

No. Original: 8140024, 1674922, 21399626, 20517007, 1674916



990

DEPÓSITO ANTICONGELANTE

VN, VNL, VNM	04/07
--------------	-------

No. Original: 20519039, 20519037



996

DEPÓSITO LIMPIA-PARABRISAS

VHD	04/12
-----	-------

No. Original: 22143196, 20481269, 20935852, 20815266, 82712975, 20912202, 20543377, 82716512



997

DEPÓSITO ANTICONGELANTE

VHD	08/15
VN	08/14
VNL, VNM	08/18
VNM	08/18

No. Original: 21846997, 22061290, 20968795, 21074569, 21000194, 21074555, 22564837, 21314361, 21067134, 21513975, 21038101

MOTORES DE DEPÓSITO DE LIMPIAPARABRISAS

VOLKSWAGEN

MOTORES DEP. LIMPIAPARABRISAS

VOLKSWAGEN



17700

Ref.: 7700AM
OE# 301177700AM

MOTOR DE DEPÓSITO DE LIMPIAPARABRISAS
GOLF-JETTA A4, NEW BEETLE

99/UP



19556

Ref.: 955651
OE# 1H6955651

MOTOR DE DEPÓSITO DE LIMPIAPARABRISAS
GOLF A3, JETTA
EUROVAN T4 2.5L

93/04
00/04



15955

Ref.: 595565
OE# 1H5955651

MOTOR DE DEPÓSITO DE LIMPIAPARABRISAS
GOLF A3-DERBY, JETTA

95/02



19652

Ref.: 955652
OE# 1J5955651

MOTOR DE DEPÓSITO DE LIMPIAPARABRISAS
JETTA A4, NEW
BEETLE, POLO, LUPO

99/UP



11695

Ref.: 169556
Oe # 1J6955651

MOTOR DE DEPÓSITO DE LIMPIAPARABRISAS
GOLF y JETTA A4

99/UP

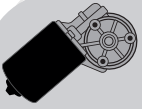

VOLKSWAGEN

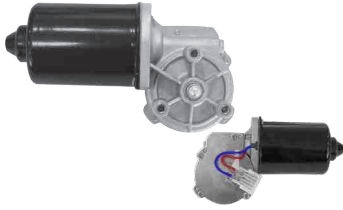

11919

Ref.: 191955
OE# 191955113A

**MOTOR DEL BRAZO
LIMPIADOR DE PARABRISAS**
GOLF y JETTA A2

87/92

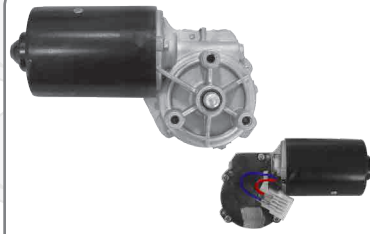

19511

Ref.: 955113
OE# 1HM955113C

**MOTOR DEL BRAZO
LIMPIADOR DE PARABRISAS**
GOLF y JETTA A3

93/99

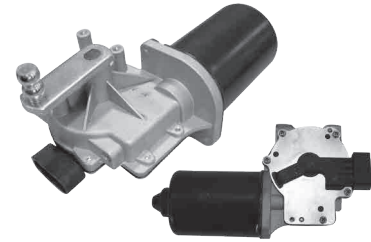

17195

Ref.: 71955E
OE# 7E1955113

**MOTOR DEL BRAZO LIMPIADOR
DE PARABRISAS**
EUROVAN T4 2.5 LTS
T5 TDI, 1.9 LTS.

00/04
05/UP



DIRECCIÓN: REPUESTOS DE DIRECCIÓN/ CAMPANAS

VOLKSWAGEN/ FORD /CHRYSLER

DIRECCIÓN

REPUESTOS DE DIRECCIÓN



57012

REF. TRANSTEC: 57012K

VW
POINTER DIRECCION
TRW BRASILEÑA

98/05

FORD



228

MAVERICK
(SIN CANDADO DE VOLANTE)

76/77

No. Original: D6DZ-7228-A



228-A

MAVERICK
GALAXIE
(CON SEGURO DE VOLANTE)

70/76
70/73

No. Original: D6BZ-7228-A



228-C

PICK-UP V8, F-100
AUTOMÁTICA

73/78

No. Original: D5TZ-7228-A



228-D

V8, F-100
F-150. (CAÑON CORTO)

80/UP
81/85

No. Original: EOTZ-7228-D

CHRYSLER



8849

CHRYSLER 6 y 8 CIL / STD.

70/82

No. Original: 3748849

DIRECCIÓN: DIAGRAMA DE FLAUTA

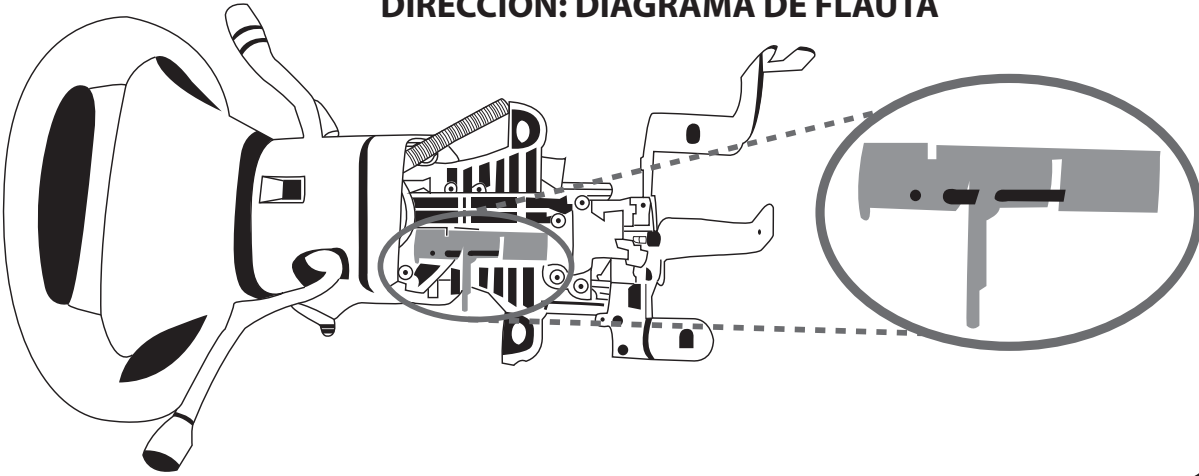

7212A-KIT

No. Original:
F57Z-7212-A
F7DZ-7R264-AA

KIT FLAUTA E INSERTO CAMPANA DE DIRECCIÓN

TRUCK E-150, 250, 350 ECONOLINE	97/02
TRUCK EXCURSION	00/05
EXPEDITION	97/02
EXPLORER	95/05
TRACK F SERIES PICK UP	99/07
SUPER DUTY, F-150 PICKUP WO/ROUGH y HERITAGE	98/03
RANGER	2004
LINCOLN BLACKWOOD	95/07
NAVIGATOR	02/03
MERCURY MOUNTAINEER	98/02
6 y 8 CIL	97/01



7212AA-KIT

No. Original:
1F1Z-7212-AA,
F7DZ-7R264-AA

KIT FLAUTA E INSERTO CAMPANA DE DIRECCIÓN

<i>SELECTOR DE VELOCIDAD</i>	
TODAS PICK UP 6 CIL TAURUS Y SABLE	90/00
CROWN VICTORIA	90/07
TAURUS	90/07
TRUCK AEROSTAR	90/91
BRONCO	92/96
E-150, 250 y 350 ECONOLINE	92/96
F SERIES PICK UP	91/97
FREESTAR	04/07
WINDSTAR	95/03
LINCOLN CONTINENTAL	90/03
LINCOLN TOWN CAR	90/04
MERCURY COLONY PARK	90/91
MERCURY GRAND MARQUIS	90/07
MERCURY MONTEREY	04/07
MERCURY SABLE 6 y 8 CIL	90/05



PARTES DIESEL Y GASOLINA

BIELAS

BIELAS



422

BIELA DE CIGUEÑAL DE COMPRESOR DE AIRE TUFLO 400 y 401

No. Original: Bendix 292527



8151

BIELA DE CIGUEÑAL DE COMPRESOR DE AIRE MOTORES DINA 155 V-6, 210 V-8 SERIES 500 y 600

No. Original Dina: 4067-05,
No. Original Cummins: 3018151



904

BIELA PARA COMPRESOR WABCO 904 MECANICO MEDIANA, MERCEDES BENZ

No. Original: 911-145-738-6



906

BIELA PARA COMPRESOR WABCO LARGA, MERCEDES BENZ

No. Original: 411-151-732-6



908

BIELA COMPRESOR BX-2150 BENDIX 88KX

No. Original: 102398



911

BIELA WABCO, CUMMINS, ISX, ISM, ISC 318

No. Original: 911-153-732-6



912

BIELA WABCO CORTA IRIZAR 2 PISTONES

No. Original: 912-560-730-6



916

BIELA WABCO, CUMMINS, ISB

No. Original: 911-153-732-6



918

BIELA P/COMPRESOR TUFLO 550 / 750 HIERRO

No. Original: 108841



924

BIELA COMPRESOR HIERRO TUFLO 501 (BENDIX)

No. Original: 246428, 286258



934

BIELA P/COMPRESOR MIDLAND 2-3/4

PARTES DIESEL Y GASOLINA

BALANCINES, COMPRESORES Y DEPÓSITOS

PARTES DIESEL



REMATE

SP-332

SOPORTE BARRA DE BALANCÍN

PERKINS DIESEL 6.354
FASE 2

No. Original: 37521332



9628

**CODO P/TAPA DE
COMPRESOR DE AIRE MOTOR**

MOTOR DINA 155 V-6, 210 V-8
SERIES 500 Y 600,
CUMMINS 350

No. Original: 196281



REMATE

PD-5170

BRIDA ARBOL DE LEVAS

MOTORES DINA 155 V-6, 210 V-8
SERIES 500 y 600
FASE 2

No. Original: 72628-05-167305



6050

RETEN RUEDA DELANTERA

DINA 531

70/UP

No. Original: A-50760-17

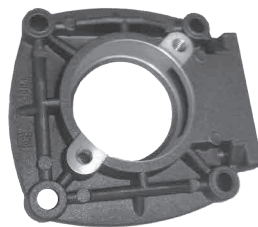

3964

TAPA DE COMPRESOR DE AIRE

DINA : 155, V-6, 210, V-8.
SERIES : 500 Y 600

No. Original: 3414-05-153964



2864

**TAPA TRASERA DE
COMPRESOR P/BUJE**

TUFLO 501 (BENDIX) POLEA,
PERKINS, GMC, CATERPILLAR

No. Original: 282064



REMATE

C-580

TAPA DE DIRECCION

CHRYSLER DIRECCION ROSS D-400, D-500, D-600
CON EJE 5000 y 7000
GENERAL MOTORS, TODO CAMION,
FORD F-600 Y B-600
6 y 8 CIL

63/79
63/UP
65/85
61/74

No. Original: 5689286

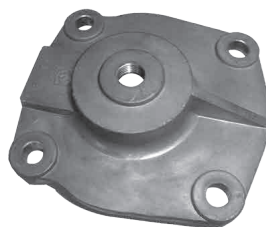

581-B

TAPA DE SECTOR

FORD CAMION F-600 y B-600
8 CIL

75/84

No. Original: D0HZ-3580-A



PARTES DIESEL Y GASOLINA

SEPARADORES DE VENTILADOR

SEPARADORES DE VENTILADOR

DIESEL

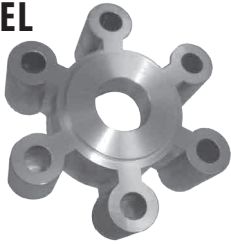

REMATE

1775

NAVISTAR MAQUINA 210

No. Original: 481775-C

GASOLINA



REMATE

700

RAMBLER AMERICAN CON AIRE
WAGONEER y PICK-UP *I*
6 CIL

75/80
79/82

No. Original: 3213700

TAPAS: DEFLECTORES / CARTER

VOLKSWAGEN



TAPAS: DEFLECTORES / CARTER

VOLKSWAGEN

REMATE



11121-K

Ref.:1121-K

TAPA DE TERMOSTATO

PASSAT 2.8L, 6 CIL

00/05

No. Original: 078-121-121-K

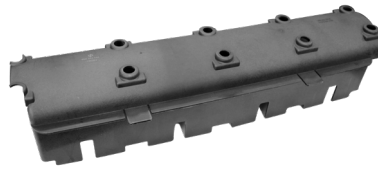

13544

Ref.:3544

DEFLECTOR ACEITE

GOLF y JETTA A4
(CABEZA-MOTOR 2.0 LITROS)

99/UP

No. Original: 06A-103-544



13547-A

REF.:3547-A

DEFLECTOR ACEITE

GOLF y JETTA A1, A2, A3, COMBI
1800
CORSA, DERBY
POINTER

00/04

No. Original: 026-103-547-A



11321-M

TAPA CARTER

JETTA CLÁSICO 2.0L, 4 CIL
CAMBIO ATOMÁTICO 4 MARCHAS

00/07

No. Original: 01M-321-359



11361-A

TAPA CARTER PARA CAJA AUTOMÁTICA

JETTA CLÁSICO 2.0L, 4 CIL

99/16

No. Original: 09G-321-361-A



13601-H

TAPA DE CARTER

JETTA CLÁSICO 1.8L, 4 CIL
TURBO (ABIERTA)

00/12

No. Original: 06A-103-601-AP

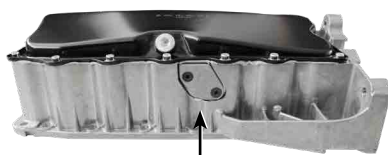

Cerrada

13601-H-T

REF.: 13601-A

CARTER VW CON TAPA (16030-A)

JETTA CLÁSICO 2.0L, 4 CIL
GOLF, BEETLE 2.0L, 4 CIL
JETTA CLÁSICO 1.8L, 4 CIL TURBO

01/11

01/07

00/12

No. Original: 06A103603AA



16030-A

TAPA P/CARTER VW (13601-H)

JETTA CLÁSICO 1.8L, 4 CIL TURBO

00/12

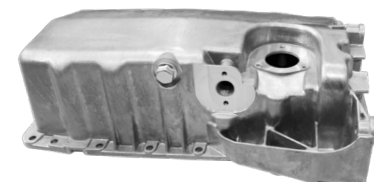

13810-M

TAPA DE CARTER

BEETLE, JETTA, GOLF, AUDI TT
QUATTRO 1.8L

00/06

No. Original: 038-103-603-M

Compañía Industrial Quezada S. A. de C. V.

San Esteban No. 47-1 Col. San Sebastián, C.P. 02040, Azcapotzalco - Ciudad de México

Tels. (01-55) 5353-0690, 5353-0816, 5353-0774 / www.quezada.com.mx / E-mail: ventas@quezada.com.mx



TAPAS: DEFLECTORES / CARTER

VOLKSWAGEN

TAPAS: DEFLECTORES / CARTER

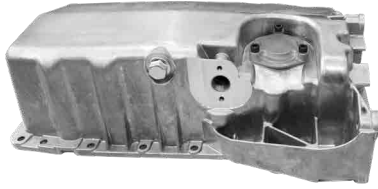

13810-M-T

CARTER VW CON TAPA (11985-C)

BEETLE, JETTA, GOLF, AUDI TT QUATTRO 1.8L

00/06

No. Original: 038-103-603-M



11985-C

TAPA P/CARTER VW (13810-M)

BEETLE, JETTA, GOLF, AUDI TT QUATTRO 1.8L

00/06

No. Original: 058 198 598 C

GENERAL MOTORS



13396

Ref.:3396
TAPÓN P/ TAPA CUBIERTA DE PUNTERÍAS

CORSA MERIVA y TORNADO 1.8L, 4 CIL
CHEVY 1.6L, 4 CIL

03/12

No. Original: 93334742



19046

Ref.:9046
TAPÓN P/ TAPA CUBIERTA DE PUNTERÍAS

CHEVY 1.6L, 4 CIL

94/12

No. Original: 90467976

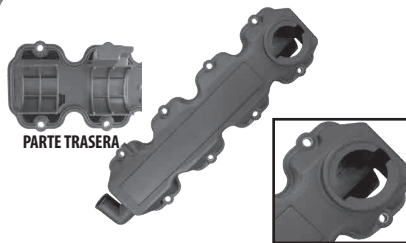

TP-14670

Ref.:4670
TAPA CUBIERTA DE PUNTERÍAS

CHEVY 1.6L, 4 CIL

94/05

No. Original: 94670481



TP-14670-T

Ref.:4670-T
TAPA CUBIERTA DE PUNTERÍAS CON TAPÓN

CHEVY 1.6L, 4 CIL

94/06

No. Original: 94670481

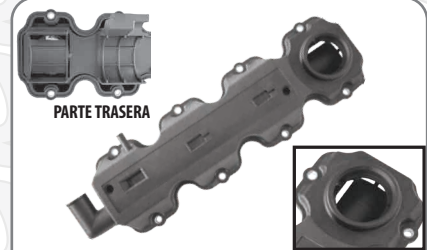

TP-14741

Ref.:4741
TAPA CUBIERTA DE PUNTERÍAS

CORSA, MERIVA y TORNADO 1.8L, 4 CIL

03/08

No. Original: 93334741

TAPAS: DEFLECTORES / CARTER/ PUNTERIAS

VW/ GENERAL MOTORS



TAPAS: DEFLECTORES / PUNTERÍA



TP-14741-T

Ref.:4741-T

TAPA CUBIERTA DE PUNTERÍAS CON TAPÓN

CORSA, MERIVA y TORNADO 1.8L, 4 CIL	03/08
CHEVY 1.6L, 4 CIL	03/08
<i>(UNICAMENTE CON TAPÓN)</i>	

No. Original: 93334741



TP-64395-1

TAPA DE CUBIERTA DE PUNTERIAS

CRUZE 1.8L, 4 CIL	10/16
TRAX 1.8L, 4 CIL	13/16
SONIC 1.6L, 4 CIL	12/16
PONTIAC G3 1.6L, 4 CIL	2009
AVEO 1.6L, 4 CIL	08/09
ASTRA, MERIVA, ZAFIRA 1.8L, 4 CIL	07/09

No. Original: 55564395

NISSAN



TP-91326

TAPA DE CUBIERTA DE PUNTERÍAS

ALTIMA 2.5L, 4 CIL	01/06
--------------------	-------

No. Original: 13264-3Z001



TP-93264-1

TAPA CUBIERTA DE PUNTERÍAS

SENTRA-B15 1.8L, 4 CIL	01/06
------------------------	-------

No. Original: 13264-4Z011



TP-92643-1

TAPA CUBIERTA DE PUNTERÍAS

ROGUE, X-TRAIL 2.5L, 4 CIL	09/13
----------------------------	-------

No. Original: 13264-JG30C



TP-96400-1

TAPA CUBIERTA DE PUNTERÍAS

URVAN 2.5L, 4 CIL MOTOR A GASOLINA	13/17
---------------------------------------	-------

No. Original: 13264-MA00A



TAPAS/ SOPORTES ÁRBOLES DE LEVAS

GENERAL MOTORS

SOPORTES/ ÁRBOLES DE LEVAS

GM

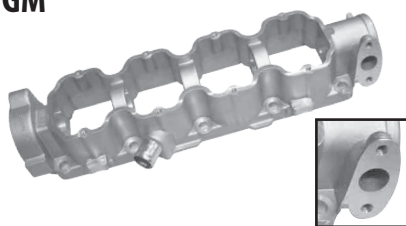

63718

SOPORTE DE ÁRBOL DE LEVAS
-ENTRADA PARA SENSOR CERRADA-

CHEVY 1.6L, 4 CIL
CORSA 1.8L, 4 CIL

94/12
03/05

No. Original: 93376218

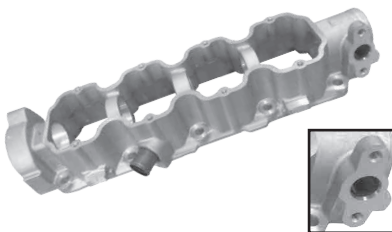

63720

SOPORTE DE ÁRBOL DE LEVAS
-ENTRADA PARA SENSOR ABIERTA-

CORSA, MERIVA y TORNADO 1.8L, 4 CIL
CON ORIFICIO PARA SENSOR

06/09

No. Original: 93376220



62244

ÁRBOL DE LEVAS

CHEVY 1.6L, 4 CIL
CORSA 1.8L, 4 CIL

02/12
03/05

No. Original: 92244916, 93244916



63219

ÁRBOL DE LEVAS

CHEVY 1.4L, 4 CIL

94/02

No. Original: 93219507, 9120301

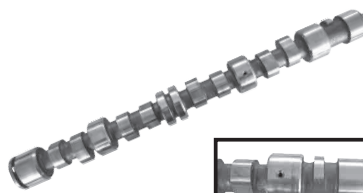

63338

ÁRBOL DE LEVAS

CORSA 1.8L, 4 CIL

06/09

No. Original: 93338425

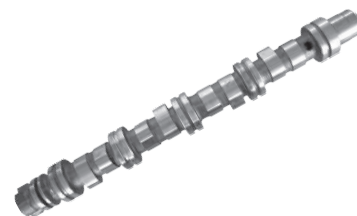

69517

ÁRBOL DE LEVAS

SPARK 1.0L, 4 CIL
MATIZ 1.0L, 4 CIL

11/UP
05/07

No. Original: 96951781

TAPAS DE DISTRIBUCIÓN

CHRYSLER / FORD



TAPAS DE DISTRIBUCIÓN

CHRYSLER

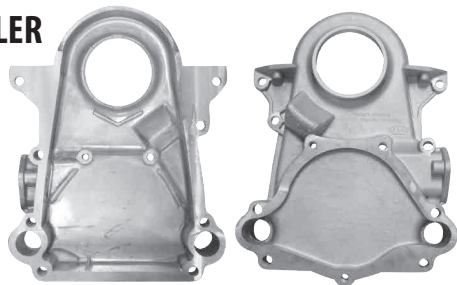

TD-5001

Ref.:TD-9964

DODGE 318, 360. 8 CIL

68/86

No. Original: D53009638

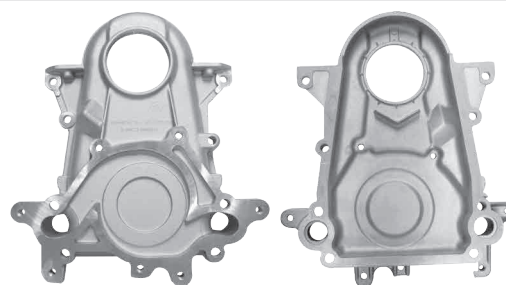

TD-5002

Ref.: TD-6705

DODGE 318 y 360 FUEL INJECTION 8 CIL

TODOS

No. Original: D53006705

FORD

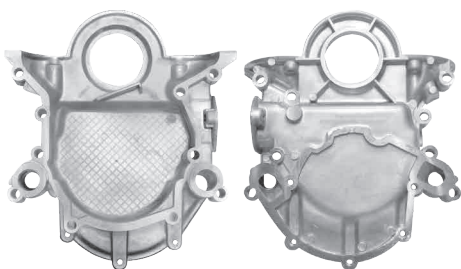

TD-7001

Ref.: TD-6059

V-8. 289, 302, 335 y 351 (SIN BARRENO)
PARA BOMBA MECÁNICA

70/91

No. Original: 86TY-6059-BB

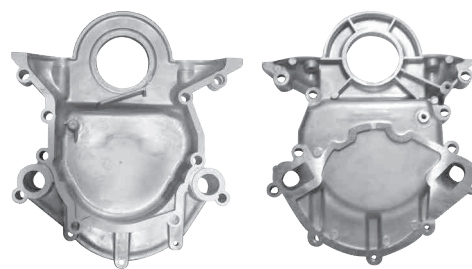

TD-7002

Ref.: TD-6019

V-8. (FUEL INJECTION) MICROBUS y PICK-UP.

92/UP

No. Original: F6TZ-6019-NA, F6TE-6059-JB

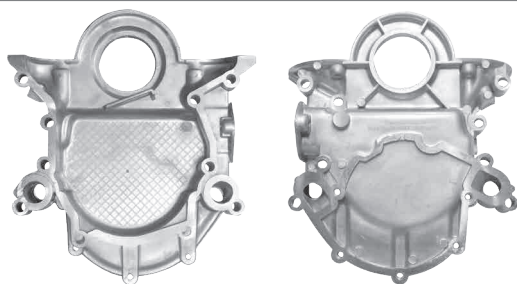

TD-7003

Ref.:TD-6059-A

V-8, 289, 302, 335 y 351 (ABIERTA)

70/91

No. Original: D0AM-6059-A

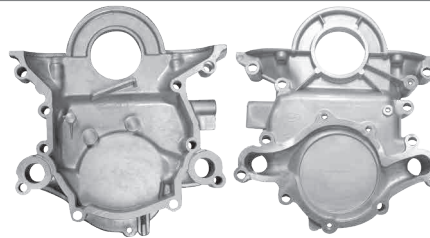

TD-7004

Ref.:TD-F152

COUGAR, THUNDERBIRD 5.0L, 8 CIL
PICK UP, F-250 8 CIL
F-350 SUPER DUTY,
EXPLORER 5.0L, 8 CIL
CLUB WAGON

89/95
87/98
99/00
96/01

No. Original: F1SZ-6019-A, F87E-6059-AA



TAPAS DE DISTRIBUCIÓN

FORD

TAPAS DE DISTRIBUCIÓN

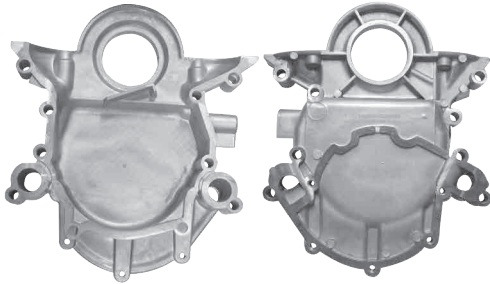

TD-7005

Ref.: TD-6059-FA

V-8, 302, 351
BOMBA DE GASOLINA ELÉCTRICA

92/UP

No. Original: E5AE-6059-FA

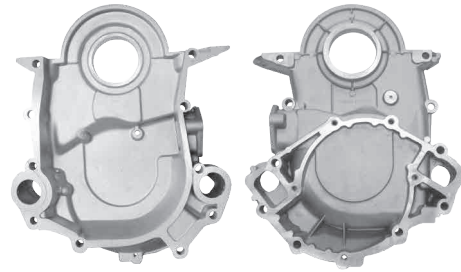

TD-7006

Ref.: TD-F460

V8, 429, 460 UNIVERSAL

76/90

No. Original: E8TE-6059-AA

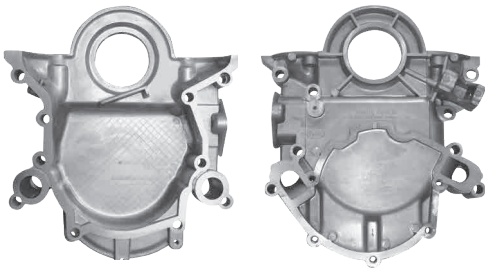

TD-7007

Ref.: TD-6059-AA

FORD V-8, 302, 351
CON SENSOR BOMBA DE GASOLINA ELÉCTRICA

85/92

No. Original: E7PE-6059-AA



TD-7008

Ref.: TD-6019H

FORD 300 3.9 y 4.9L, 6 CIL COUNTRY, CUSTOM,
GALAXIE BRONCO SERIES

87/91

No. Original: E5TE-6019-H



TD-7009

Ref.: TD-6019-D

FORD WINDSTAR 3.8L

95/00

No. Original: F4SZ-6019-DA

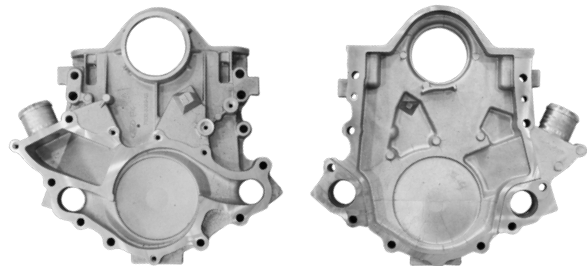

TD-7010

Ref.: TD-6019-A

FORD WINDSTAR 3.0L

95/98

No. Original: F4SZ-6019-A

TAPAS DE DISTRIBUCIÓN

GENERAL MOTORS



TAPAS DE DISTRIBUCIÓN

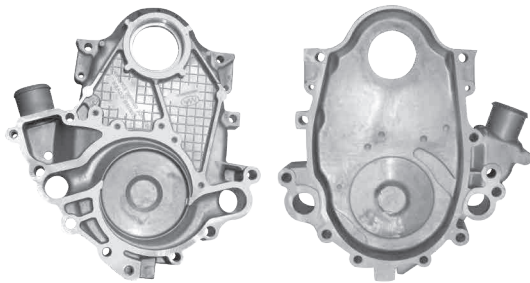

TD-6001

Ref.: TD-0537

PICK-UP y BLAZER 2.8L , 6 CIL
CAMARO, FIREBIRD, 5-10 2.8L

85/92

No. Original: 14090537

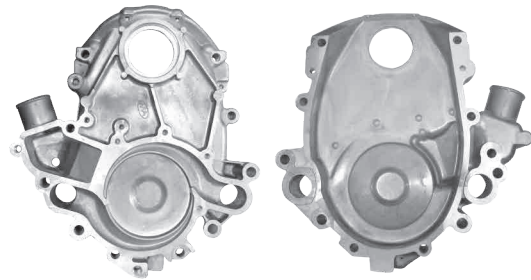

TD-6002

Ref.: TD-4263

CUBIERTA DE TIEMPO GM BLAZER, CAMARO, FIREBIRD
y 5-10 MOTOR 173 2.8L (COLA DE PATO)

90/00

No. Original: 14024263



TD-6003

Ref.: TD-KITS/CHEVY

CHEVY KIT 3 TAPAS DISTRIBUCIÓN 1.4 y 1.6 L
(TRASERA, SUPERIOR E INFERIOR)

94/12

No. Original: 93441534, 93441535, 93441536

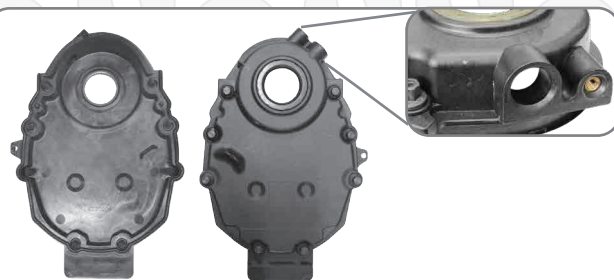

TD-6004

Ref.: TD-4318

MOTORVORTEC 8 CIL 350 5.7L y 305 5.0L
CON ENTRADA PARA SENSOR

96/UP

No. Original: 12562818

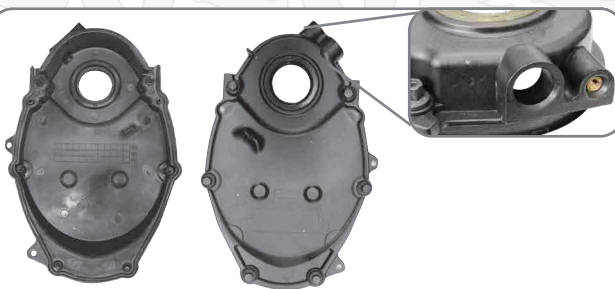

TD-6005

Ref.: TD-5557

MOTORVORTEC 6 CIL 262 4.3L
CON ENTRADA PARA SENSOR

96/UP

No. Original: 12554557



TD-6006

Ref.: TD-2883

PONTIAC 4.9, 5.7, 6.6 y 7.5L V8
CON MARCA DE TIEMPO

69/77

No. Original: 482883

Compañía Industrial Quezada S. A. de C. V.

San Esteban No. 47-1 Col. San Sebastián, C.P. 02040, Azcapotzalco - Ciudad de México

Tels. (01-55) 5353-0690, 5353-0816, 5353-0774 / www.quezada.com.mx / E-mail: ventas@quezada.com.mx



TAPAS DE DISTRIBUCIÓN

GENERAL MOTORS/NISSAN

TAPAS DE DISTRIBUCIÓN

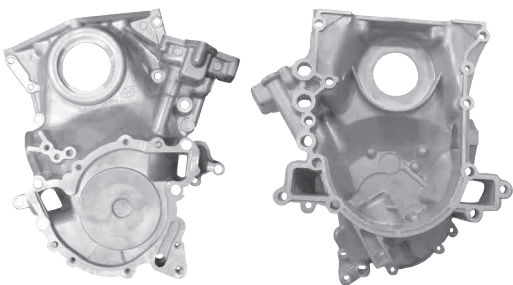

TD-6007

Ref.: TD-5465

BUICK 6.2, 3.8, 4.1, 5.7L V6, V8 TRANS TRAS 72/94

No. Original: 25525465

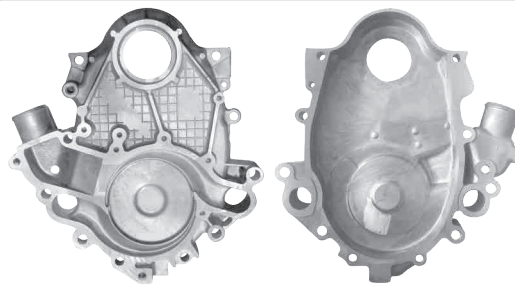

TD-6008

Ref.: TD-9037

CHEVROLET 2.8 y 3.1L, S-10 BLAZER V6, PICK UP, FIREBIRD 82/92

No. Original: 12509037

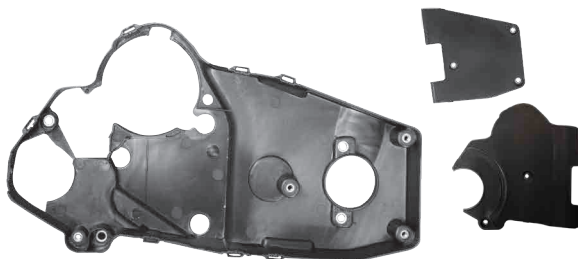

TD-6012

Ref.: TD-KITS/CORSA

CORSA 1.8L KIT 3 TAPAS DISTRIBUCIÓN (TRASERA, SUPERIOR E INFERIOR) 03/09

No. Original: 93386262, 93388683, 93388684

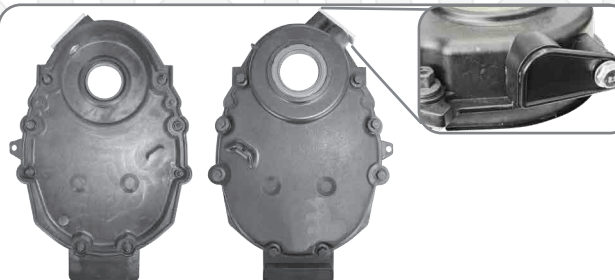

TD-6013

MOTOR VORTEC 8 CIL 350 5.7L y 305 5.0L 96/UP
SIN ENTRADA PARA SENSOR

No. Original: 12558343

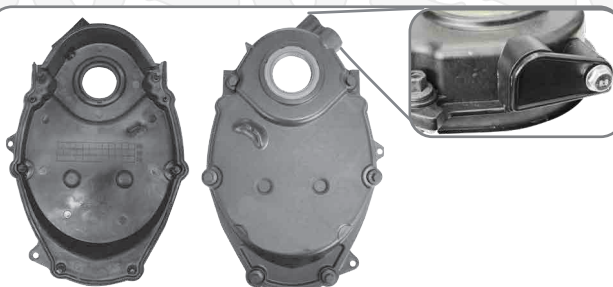

TD-6014

MOTOR VORTEC 6 CIL 262 4.3L 96/UP
SIN ENTRADA PARA SENSOR

No. Original: 12554555

NISSAN



Tiempo de Perno Alto

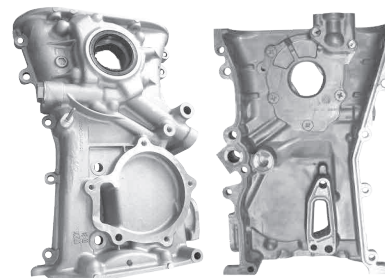

TD-9001

Ref.: TD-1206

TSURU III, TSUBAME 94/UP
SENTRA B-14 TODOS 16V 96/00

No. Original: 13500-F4300

TAPAS DE DISTRIBUCIÓN

NISSAN



TAPAS DE DISTRIBUCIÓN



Tiempo de Perno Bajo

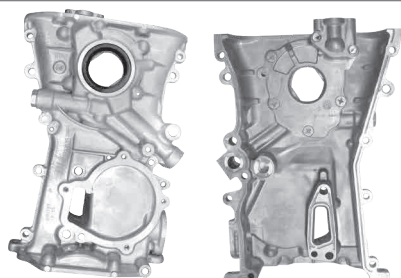

TD-9002

Ref.: TD-1207

SENTRA B-13
TSURU III
(TIEMPO DE PERNO BAJO)

93/94

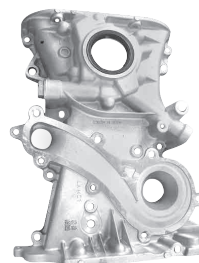

TD-9003

Ref.: TD-1213

SENTRA 1.8L, 16V H5 B-15 4 CIL

01/06

No. Original: 13500-5M000

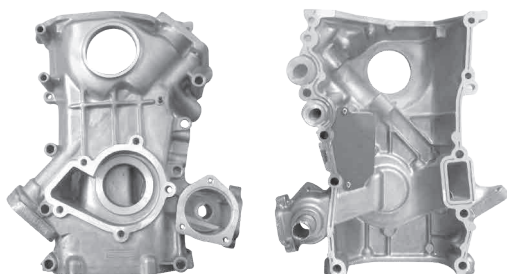

TD-9004

Ref.: TD-S701

CAMIONETA D21 MOTOR 2.4L

96/04

No. Original: 13501-1S701

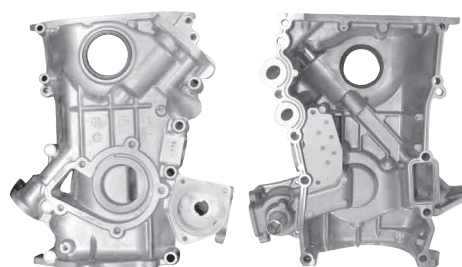

TD-9005

Ref.: TD-J26A

URVAN 2.4L

02/07

No. Original: 13500-VJ26A



TD-9006

Ref.: TD-A00A

ALTIMA, URVAN 2.5 16V, 4 CIL

07/UP

No. Original: W13500-JA00A

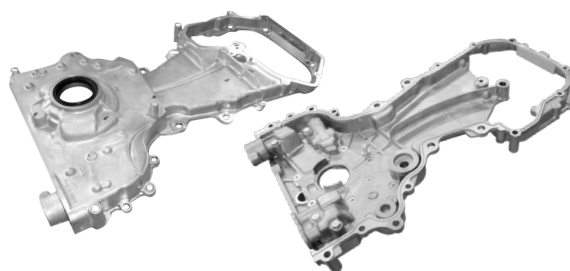

TD-9007

Ref.: TD-J002

ALTIMA y XTRAIL 2.5L, 16V, 4 CIL

00/06

No. Original: W13500-8J002

Compañía Industrial Quezada S. A. de C. V.

San Esteban No. 47-1 Col. San Sebastián, C.P. 02040, Azcapotzalco - Ciudad de México

Tels. (01-55) 5353-0690, 5353-0816, 5353-0774 / www.quezada.com.mx / E-mail: ventas@quezada.com.mx



TAPAS DE DISTRIBUCIÓN

TOYOTA/ VOLKSWAGEN

TAPAS DE DISTRIBUCIÓN

TOYOTA

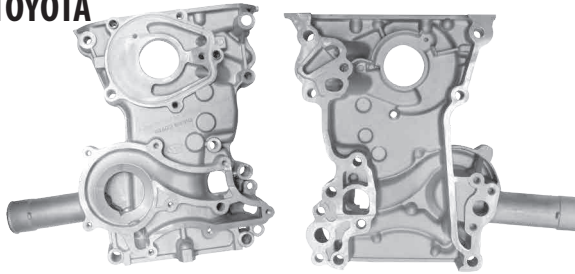

TD-9101

Ref.: TD-8010

PICK-UP MOTOR 2.4L

85/96

No. Original: 11302-35010

VOLKSWAGEN

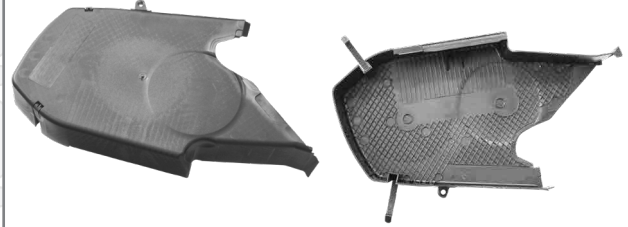

TD-1002-1

CUBIERTA DE BANDA DE DISTRIBUCIÓN
JETTA A4 2.0L, 4 CIL

00/UP

No. Original: 06A-109-108-T



TD-1003

TOLVA P/CUBIERTA DE BANDA DENTADA

CARIBE, ATLANTIC, GOLF y JETTA A2 1.6, 1.7 & 1.8L

83/92

No. Original: 261-091-731

TOMAS DE AGUA

ESQUEMA DE KIT



TOMAS DE AGUA

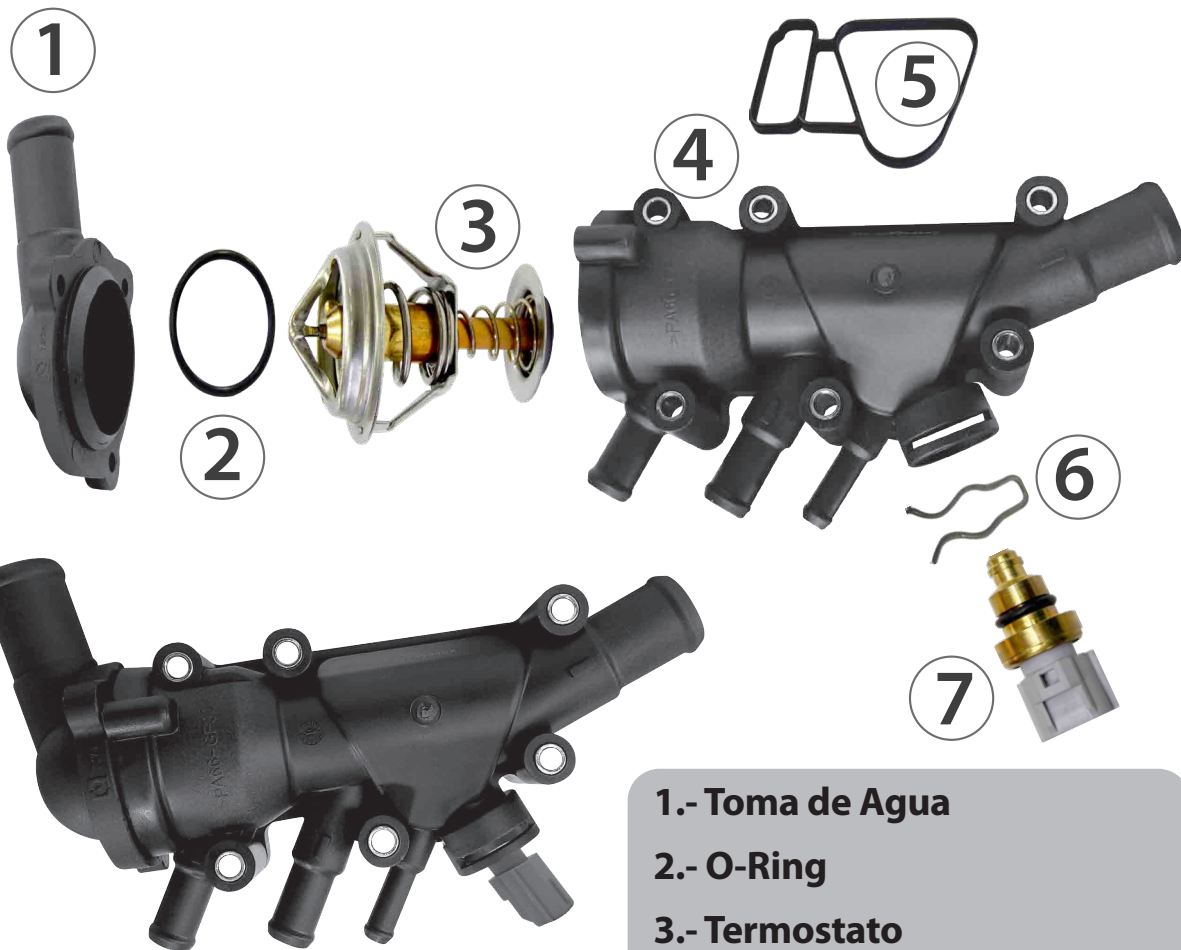

- 1.- Toma de Agua
- 2.- O-Ring
- 3.- Termostato
- 4.- Caja de termostato (Housing)
- 5.- Liga
- 6.- Seguro
- 7.- Sensor de termostato



Toma de Agua



Toma de Agua
con termostato

NOMENCLATURA DE TOMAS Y TERMOSTATO:

T-#TOMA= TERMOSTATO INDIVIDUAL



#TOMA-T= TOMA CON TERMOSTATO





TOMAS DE AGUA

ACURA/AUDI

TOMAS DE AGUA

ACURA



9136

AMERICANA

ACURA	86/90
ALL AMC & JEEP 258 (4.2L), 151(2.5L),	81/90
JEEP CHEROKEE,	
COMANCHE, WAGONNER 4.0L	89/90

No. Original: 3235347
Ref.: 5347/8178

AUDI



109-AQ

NACIONAL

CODO DE AGUA EN FORMA DE "Y" CON MANGUERA	
GOLF y JETTA A4, SHARAN, AUDI	00/05
TURBO 1.8L	

No. Original: 1J0-122-109-AQ



111-D

CON TERMOSTATO

A3 V6 3.2L	06/07
A4 y A6 V6, 3.2L	
TT V6 3.2L	04/06

No. Original: 06E-121-111-D



111-K

NACIONAL
HOUSING CON TOMA DE AGUA,
TERMOSTATO Y SENSOR DE TEMPERATURA

A4 1.8L, 4 CIL	04/UP
----------------	-------

No. Original: 06B-121-111-K

AUDI/VW



122

NACIONAL

A4 AVANT (8D5, B5)	96/01
A6 AVANT (4B, C5) 4 CIL	97/05

AMERICANA

A4 1.6 AHL	95/01
A6 AJP, AQE, ARH, AWT 1.8 PASSAT	98/05
4 MOTION AHL,	97/02
ARM APV, ANA 1.6	

No. Original: 06B-121-121



132-F

NACIONAL

A4 (8D2, B5) 1.6L, 4 CIL	00/07
PASSAT (3B2)	00/07

AMERICANA

PASSAT AUG 1.8	98/01
A4 AWT 1.8	99/01
A6 APV, AEB, AWT 1.8	98/01

No. Original: 058-121-132-A,
058-121-132-B, 058-121-132-C



133-A

NACIONAL Y AMERICANA

GOLF 1.8L, 4 CIL	82/93
AUDI 80 1.8L, 4 CIL	84/86
AUDI COUPE 1.8L, 4 CIL	84/88

No. Original: 027-121-133,
027-121-133-A



133-BC

NACIONAL

PASAT 1.8L, 4 CIL	-/02
AUDI 1.8L, 4 CIL (BASE CORTA 8 CM)	

No. Original: 06B-121-133-D



133-BL

NACIONAL

PASAT 1.8L, 4 CIL	03/UP
AUDI 1.8L, 4 CIL (BASE LARGA 9 CM)	

No. Original: 06B-121-133-D



133-E

NACIONAL

AUDI A4	95/00
A4 AVANT	96/01
A6 1.8L, 4 CIL	97/05
PASSAT	96/00

AMERICANA

AUDI 200 ANZ 1.8	96/99
------------------	-------

No. Original: 058-121-133-B



133-J

NACIONAL

AUDI, PASSAT 1.6L, 4 CIL	00/UP
--------------------------	-------

No. Original: 06D-121-133-C



145-B

NACIONAL

AUDI 80	90/91
AUDI 80 (8C, B4) 4 CIL	91/94
PASSAT (3B6)	00/05

AMERICANA

AUDI, CABRIO 2.0 A6, ABK	92/00
--------------------------	-------

No. Original: 048-121-145-B

BMW



4502

NACIONAL

SERIE 5 E39 2.0L, 4 CIL	95/98
SERIE 7 E38 3.0L, 6 CIL	

No. Original: 11 53 1 740 478



4503

NACIONAL

SERIE 5 E34 530I, 540I	
SERIE 5 E34 TOURING 530I 3.0L, 6 CIL	
SERIE 5 E34 TOURING 540I	
SERIE 7 E38	
SERIE 8 E31 840I 4.4L, 8 CIL	

No. Original: 11 53 1 720 173



4504

**NACIONAL
CON TERMOSTATO**

SERIE 3 E36 316I, 318I, Z3 E36 2.0L, 4 CIL	93/00
--	-------

No. Original: 11 53 1 739 752,
1153 1 247 125, 11 53 1 432 881,
11 53 1 739 755, 11 53 1 743 544



TOMAS DE AGUA

BMW

TOMAS DE AGUA



4506

NACIONAL

SERIE 3 E36 316I, 318I 90/95
SERIE 5 518I 2.0L, 4 CIL

No. Original: 11 53 1 247 122



4509

NACIONAL

SERIE 3 E46 316I, 318I 95/98
Z3 E36 2.0L, 4 CIL

No. Original: 11 53 1 709 232



4513

NACIONAL
CON TERMOSTATO

SERIE 1 E81 04/UP
SERIE 1 E87 1.6L, 4 CIL
SERIE 3 E46 98/UP
SERIE 3 E90 2.0L, 4 CIL

No. Original: 11 51 7 500 597



4507

NACIONAL

SERIE 3 E46 316I, 318I 98/05
Z3 E36 2.0L, 4 CIL

No. Original: 11 53 1 708 808



4511

NACIONAL
CON TERMOSTATO

SERIE 1 E81, SERIE 1 E82 04/UP
SERIE 1 E87, SERIE 1 E88
SERIE 3 E90, SERIE 3 E91 1.6L, 4 CIL
SERIE 3 E92, SERIE 3 E93, SERIE 5 05/UP
E60, SERIE 5 E61 2.0L, 4 CIL

No. Original: 11 53 7 549 476



4508

NACIONAL

SERIE 5 E39 2.0L, 4 CIL 93/00
SERIE 7 E38 3.0L, 6 CIL

No. Original: 11 53 1 743 679



4514

NACIONAL

SERIE 1 1.6L, 4 CIL 04/UP
SERIE 3 2.0L, 4 CIL 02/UP
SERIE 5 2.0L, 4 CIL 07/10
X3 2.0L, 4 CIL 03/10

No. Original: 11 51 7 572 859,
11 51 7 506 576



4515

NACIONAL
CON TERMOSTATO

SERIE 3 E46 2.0L, 4 CIL	98/05
SERIE 5 E60 2.0L, 4 CIL	98/UP
SERIE 7 E38, E65 3.0L, 6 CIL	98/UP
X3 2.0L, 4 CIL	-/10
X5 3.0L, 6 CIL	-/07

No. Original: 11 53 1 437 040,
11 53 1 436 823, 11 53 1 437 040,
11 530 139877



4516

NACIONAL
CON TERMOSTATO

SERIE 3 E46 2.0L, 4 CIL	98/03
SERIE 5 E39 2.0L, 4 CIL	98/04
SERIE 7 E38 3.0L, 6 CIL	98/01
X5 3.0L, 6 CIL	01/03

No. Original: 11 51 2 354 056,
93171547, 13 38 139

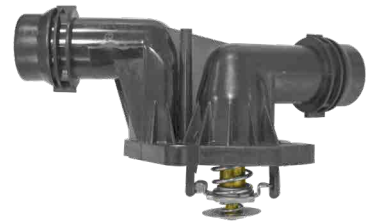

4517

NACIONAL
CON TERMOSTATO

SERIE 3 E46 2.0L, 4 CIL	98/05
SERIE 5 E39 2.0L, 4 CIL	00/03

No. Original: 11 53 2 247 019,
11 53 2 247 020



4518

NACIONAL
CON TERMOSTATO

SERIE 1 E81, E82, E84, E87 1.6L, 4 CIL	04/UP
SERIE 3 E90, E91, E92, E93 2.0L, 4 CIL	05/UP
SERIE 5 E60, E61 2.0L, 4 CIL	05/UP
SERIE 7 E63, E64, E65, E66 3.0L, 6 CIL	04/UP
X3 2.0L, 4 CIL	06/10

No. Original: 11 53 7 552 403,
11 53 7 536 655, 11 53 7 544 788



4519

NACIONAL

SERIE 3 E36, E46 316I, 318I 2.0L, 4 CIL	
--	--

No. Original: 11 53 1 743 329



CON TERMOSTATO

4520

NACIONAL

540I	98/03
740I	98/01
740IL	98/01
X5	00/03
Z8	2003

No. Original: 11 53 1 436 386



TOMAS DE AGUA

CHRYSLER: DODGE-RAM-JEEP

TOMAS DE AGUA

CHRYSLER



5022

AMERICANA

DODGE D 50 & 2.0L (U) & 156 2.6L POWER RAM PICK-UP (F&W) 6 CIL 79/86

No. Original: MD020634
Ref.: 9171

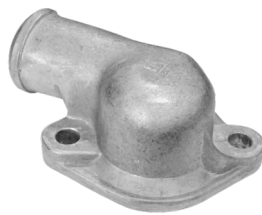

5023

NACIONAL Y AMERICANA

Ref.:524

DODGE & PLYMOUTH 3.7L, 4.0L, 6 CIL CHRYSLER 6 CIL MOTOR 225 AUTOS, CAMIONES Y CAMIONETAS 60/85 65/UP

No. Original: 2121524, 2121908

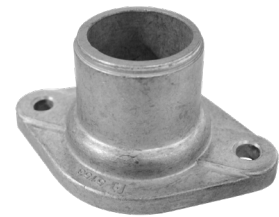

5153

AMERICANA

ALL DODGE L.D. TRUCK 239 3.9L V-8 LE BARON. CAMIONETAS. 87/91 79/82 70/UP

No. Original: 4100490
Ref.: 490



5063

NACIONAL CHRYSLER V8 318 Y 360

AMERICANA CHRYSLER, DODGE, PLYMOUTH V8 CIL 83, 318 CAMIONETAS MAQ. 318, 360 400 y 440 DODGE 67/78 74/78 61/78

No. Original: 3698565, 2780970, 3751958

Ref.: 4013



5083

AMERICANA

DODGE (EXC. STEALTH), PLYMOUTH 3.0L V 8 59/71

No. Original: 1855605



5169

NACIONAL Y AMERICANA

ALL CHRYSLER, 135 2.2L, 150 2.5L & 1.6L CHRYSLER 4 CIL SERIE "K" y "E" BODY SHADOW, SPIRIT, PHANTOM DAKOTA 82/90 82/UP 86/90 83/90 82/83 82/89 82/88 83/87 81/87 85/89

No. Original: 5214514
Ref.: 4514



5096

AMERICANA

CHRYSLER TODOS MAQ. 383 A/C 8 CIL DODGE y PLYMOUTH MAQ. 400 y 440 D-600 1971 1972

No. Original: 3614013, 3614012



5172

AMERICANA

CHRYSLER, DODGE (EXCEPT STEALTH), PLYMOUTH V-6 3.0L	87/94
---	-------

No. Original: MD097041

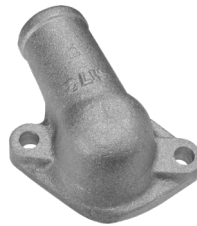

5173

AMERICANA

CHRYSLER TOWN & COUNTRY 3.3, 3.8L, 6 CIL	90/92
DODGE DYNASTY 3.3L	90/93
DODGE CARAVAN, MINI RAM 3.3L y PLYMOUTH VOYAGER	90/92

No. Original: 5281188



5174

AMERICANA

SHADOW, SPIRIT, LEBARON 2.5L	91/94
CARAVAN, VOYAGER 3.3L	93/94
TOWN & COUNTRY TODAS	

No. Original: 5281063



5175

NACIONAL Y AMERICANA

B150, 1500, 250, 2500, 350 VAN, D 150, 250, 350 PICK-UP, DAKOTA DURANGO, JEEP GRAND CHEROKEE, RAM 1500 2500, 3500, 3.9, 5.2 y 5.9L	94/00
DODGE	92/03

No. Original: 53020115



5176

NACIONAL Y AMERICANA

GRAND VOYAGER, TOWN & COUNTRY, CARAVAN, GRAND CARAVAN V-6 3.3 y 3.8L; VOYAGER 2000, CHRYSLER	99/00
DODGE Y PLYMOUTH	90/00 96/00

No. Original: 4621162AC



5177

NACIONAL Y AMERICANA

DODGE R 2500, 3500 PICK-UP	
DODGE RAM 2500, 3500	
PICK-UP 5.9L	

No. Original: 53006192



5178

NACIONAL Y AMERICANA

DODGE R 2500, 3500 PICK-UP	94/98
DODGE RAM 2500, 3500 PICK-UP 5.9L	94/99

No. Original: 04761293



TOMAS DE AGUA

CHRYSLER: DODGE-RAM-JEEP

TOMAS DE AGUA



5179

NACIONAL Y AMERICANA

DODGE RAM 2500, 3500
PICK-UP 5.9L, 6 CIL 00/UP

No. Original: 5015713AA



5180

NACIONAL
CIRRUS 2000 2.0L, 4 CIL (UN ÁRBOL) 94/00

AMERICANA
CIRRUS SOHC 4 CIL 2.0L 95/99
NEON SOHC 95/00
STRATUS SOHC 95/00
BREEZE SOHC 96/00
DODGE y PLYMOUTH 95/00

No. Original: 4546729



5181

NACIONAL
NEON 2000 2.0L, 4 CIL 00/06

AMERICANA
NEON 2.0L, 4 CIL 00/01
ACR Y ES 02
R/T 01/04
SE 02/05
SXT, CHRYSLER 00
DODGE 00/05
PLYMOUTH 00/01

No. Original: 5278156AA



5182

NACIONAL
STRATUS 2.4L, 4 CIL 95/06

AMERICANA
CIRRUS, SEBRING 96/00
STRATUS 95/06
BREEZE 2.0L, 4 CIL 98/00

No. Original: 04663501AA



5184

NACIONAL Y AMERICANA

STRATUS TURBO 2.4L, 4 CIL 96/02

No. Original: 04849098AC



5185

NACIONAL
NEON 2.0L, 4 CIL 03/05
STRATUS 2.0L, 4 CIL 02/06

AMERICANA
NEON 2.0L, 4 CIL 03/05
STRATUS 2.0L, 4 CIL 05/06

No. Original: 04777171AB



5183

NACIONAL Y AMERICANA

NEON 2.0L, 4 CIL DHOC (DOS
ÁRBOLES) 95/99

No. Original: 04495717

DISPONIBLE TAMBIÉN EN LA SECCIÓN
DE TUBOS Y MANGUERAS

TOMAS DE AGUA

CHRYSLER: DODGE-RAM-JEEP



TOMAS DE AGUA



5186

NACIONAL PT CRUISER 2.4L, 4 CIL	00/09
AMERICANA PT CRUISER PT CRUISER LIMITED, PT CRUISER STREET CRUISER, PT CRUISER TOURING 2.4L, 4 CIL	01/07 2006
No. Original: 05278203AB	



5187

NACIONAL INTREPID 2.7L, 6 CIL	96/01
AMERICANA INTREPID, INTREPID ES INTREPID SE CONCORDE CONCORDE LX 2.7L, 6 CIL	98/01 02/04 98/01 02/04
No. Original: 04792328	



5188

NACIONAL CIRRUS V6 2.7L	01/06
AMERICANA SEBRING V6 2.7L CON SENSOR DE TEMPERATURA	01/06
No. Original: 04792630AA	



5189

NACIONAL CHARGER, CONCORDE, CIRRUS, STRATUS 2.7L, 300 LE, LX, L2 6 CIL	06/10
AMERICANA CONCORDE V6 2.7L	98/02
No. Original: 05017183AB	

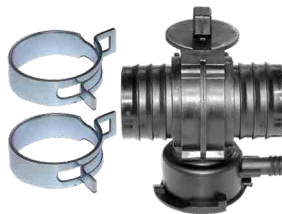

5190

NACIONAL RAM VAM, PICK UP, DAKOTA, CHEROKEE, DURANGO 3.9L, 8 CIL	00/03
AMERICANA DAKOTA V6 3.9L DURANGO	00/03 00/04
No. Original: 52029195AK	



5191

NACIONAL Y AMERICANA	
INTREPID 3.2L, 6 CIL	98/00
No. Original: 04792361	



TOMAS DE AGUA

CHRYSLER: DODGE-RAM-JEEP

TOMAS DE AGUA



5192

NACIONAL Y AMERICANA

V6 2.5L, SEBRING JX y JXI	96/00
LX y LXI	95/00
AVENGER	97/00
AVENGER COUPE DODGE V6 2.5L	95/98

No. Original: 191144830

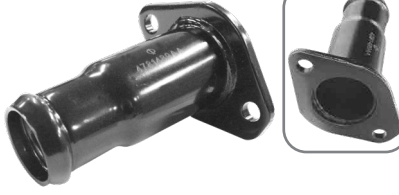

5193

NACIONAL

JEEP WRANGLER 2.4L 4 CIL	01/08
--------------------------	-------

AMERICANA

VOYAGER y CARAVAN	01/03
SE	04/07
LIBERTY	02/05
WRANGLER 2.4L, 4 CIL	03/06

No. Original: 4781489AA



5194

NACIONAL

VOYAGER 3.0L, 6 CIL	91/00
---------------------	-------

AMERICANA

VOYAGER 00	00
DODGE CARAVAN	96/00
GRAND CARAVAN, PLYMOUTH	96/97
GRAND VOYAGER	
PLYMOUTH VOYAGER 3.0L, 6 CIL	96/00

No. Original: 4625656



5195

NACIONAL

RAM, DURANGO, NITRO, LIBERTY, CHEROKEE 6 y 8 CIL 3.7 y 4.7L	99/12
---	-------

AMERICANA

DODGE DAKOTA, DURANGO 4.7L, 8 CIL	00/09
DODGE DAKOTA, DURANGO 3.7L, 6 CIL	04/05
DODGE RAM 1500 PICK UP 3.7L, 6 CIL	02/07
DODGE RAM 1500 PICK UP 4.7L, 8 CIL	02/07
JEEP GRAND CHEROKEE LAREDO, LIMITED 4.7L, 8 CIL,	00/07
JEEP GRAND CHEROKEE OVERLAND 4.7L, 8 CIL,	0/04
JEEP LIBERTY LIMITED, RENEGADE, SPORT 3.7L, 6 CIL,	03/05
CHRYSLER ASPEN LIMITED 4.7L, 8 CIL	07
JEEP COMMANDER 4.7L, 8 CIL	06/07
MITSUBISHI RAIDER 3.7L, 6 CIL	06/07

No. Original: 53020887AD



5196

NACIONAL

AVENGER 2.0L, 4 CIL	06/15
COMPASS PATRIOT 2.0L, 4 CIL	
JOURNEY 2.4L, 4 CIL	
CALIBER 1.8L, 4 CIL	

AMERICANA

CHRYSLER SEBRING, JEEP COMPASS y PATRIOT 2.4L, 4 CIL	06/15
---	-------

No. Original: 4884571AB



5197

NACIONAL

MAGNUM, 300, CHARGER 2.7L, 6 CIL	04/10
----------------------------------	-------

AMERICANA

CHRYSLER 300, DODGE CHARGER y MAGNUM 2.7L, 6 CIL	07
---	----

No. Original: 4792916AE

TOMAS DE AGUA

CHRYSLER: DODGE-RAM-JEEP



TOMAS DE AGUA



5198

NACIONAL

300C 2.7L, 6 CIL MAGNUM, 300, CHARGER 2.7L, 6 CIL	06/10 00/10
--	----------------



5199

NACIONAL

CIRRUS 2.7L, 6 CIL	01/06
--------------------	-------

No. Original: 04792612AA



5200

NACIONAL

CIRRUS, SEBRING 2.5L, 6 CIL	96/01
-----------------------------	-------

No. Original: MD308982



5201

NACIONAL

VOYAGER 3.8L, 6 CIL	01/UP
---------------------	-------

No. Original: 04781387AA



5202

ATTITUDE 1.4 & 1.6L, 4 CIL VERNA 1.6L, 4 CIL	05/11 TODOS
---	----------------

No. Original: 25611-26100
Ref.: 9510

5202-T

Ref.: 9510-T

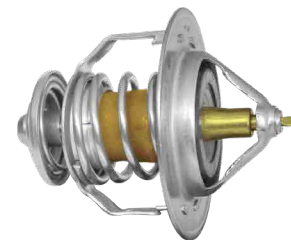

T-5202

ATTITUDE 1.4 & 1.6L, 4 CIL VERNA 1.6L, 4 CIL	05/11 TODOS
---	----------------

No. Original: 25611-26100
Ref.: T-9510

APLICA PARA TOMA DE AGUA 5202



5203

ATTITUDE 1.4 & 1.6L, 4 CIL VERNA 1.6L, 4 CIL	05/11 TODOS
---	----------------

No. Original: 25620-26160
Ref.: 9511

APLICA PARA T/A 5202

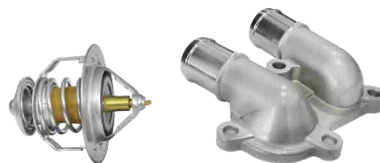

APLICA PARA HOUSING 5203



TOMAS DE AGUA

CHRYSLER/ FIAT

TOMAS DE AGUA



5202-KIT

(TOMA DE AGUA, HOUSING Y TERMOSTATO)

ATTITUDE 1.4 y 1.6L, 4 CIL	05/11
VERNA 1.6L, 4 CIL	TODOS

No. Original: 25611-26100,
25620-26160
Ref.: 9510-KIT



5204

VOYAGER 3.3 & 3.8L, 6 CIL	01/07
PACIFICA 3.8L, 6 CIL	07/08

No. Original: 4666054AA



5205

TOWN & COUNTRY, GRAND	11/15
CARAVAN, JOURNEY 2.4L, 4 CIL	
AVENGER, 200 2.4L, 4 CIL	11/14

No. Original: 5184570AH



5207

CHRYSLER 200 2.4L, 4 CIL	15/17
DODGE DART 2.0L, 2.4L, 4 CIL	12/15
JEEP CHEROKEE 2.4L, 4 CIL	14/19
JEEP RENEGADE 2.4L, 4 CIL	15/19

No. Original: 05047772AB



5206

AVENGER 2.4L 4CIL	10/14
-------------------	-------

No. Original: 68003582AB

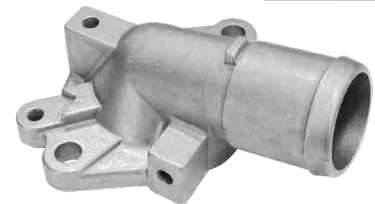

NUEVO

5208

GALANT, GRANDIS 2.4L 4 CIL	03/10
----------------------------	-------

No. Original: MN149478



NUEVO

5209

RAM PICK UP 2500 6.7L	13/17
-----------------------	-------

No. Original: 68210190AA

FIAT

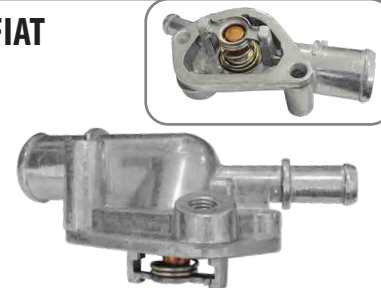

4301

NACIONAL Y AMERICANA

FIAT PALIO, SIENA y STRADA 1.6L, 4 CIL/ 8V	98/00
--	-------

No. Original: 7778655

TOMAS DE AGUA

FORD: MERCURY-LINCOLN



TOMAS DE AGUA

FORD



7009

AMERICANA

COURIER PICK-UP 110 & 122 1.8L, 4 CIL MAZDA B SERIES PICK-UP 1000CC, 1200CC, 1600CC, 1800CC, 2000CC & 2200CC 72-82, 4 CIL	72/80 72/82
--	----------------

No. Original: D27Z-8592-B,
0290-15-172A, 0290-15-1720
Ref.: 9198

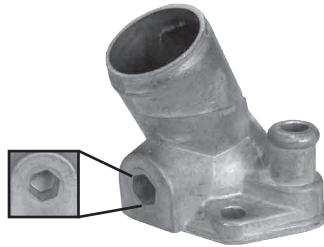

7026

SIN ENTRADA DE VÁLVULA DIFUSORA
DE TEMPERATURA

NACIONAL FORD V8 F100, 150, 200, 250, 350 Y 600	98/00
--	-------

AMERICANA FORD TODOS MAQ 289 BRONCO MAQ 305, 335, 351	60/61 65/69
--	----------------

No. Original: C5AZ-8592-E
C90Z-8592-A
Ref.: 1592-B



7047

AMERICANA

B-F-N 100/700 272 P 350/500 292 V8; ALL FORD TRUCK 239 y 256 6 CIL 54 y 55	56/58 58/64
---	----------------

No. Original: B5C-8592-A



7051

AMERICANA

FORD SERIES E y F 100/350 ECONOLINE VAN y PICK-UP MAQ 300 EXCEPTO CALIFORNIA	73/78
SERIE P 350/500 STEP VAN y PARCEL DELIVERY MAQ 300	73/76

No. Original: C8AZ-8592-B, C5AZ-8592-A,
C5AZ-8592-D



7064

AMERICANA

FORD CAMIONETAS TODAS MAQ 330, 361 y 391	66/74
FORD CAMIONETAS TODAS MAQ 351	64/67

No. Original: C4TZ-8592-B



7050

AMERICANA

FORD TODOS MAQ. 352, 390 410 V-8 MERCURY MAQ 427 y 428	65/67
--	-------

No. Original: C5AZ-8592-B



7073

AMERICANA

FORD y MERCURY TODOS MAQ 289 BRONCO TODOS MAQ 302 LINCOLN MERCURY	60/61 65/69 77/90 63/91
--	----------------------------------

No. Original: C5AZ-8592-E

Compañía Industrial Quezada S. A. de C. V.

San Esteban No. 47-1 Col. San Sebastián, C.P. 02040, Azcapotzalco - Ciudad de México

Tels. (01-55) 5353-0690, 5353-0816, 5353-0774 / www.quezada.com.mx / E-mail: ventas@quezada.com.mx



TOMAS DE AGUA

FORD: MERCURY-LINCOLN

TOMAS DE AGUA

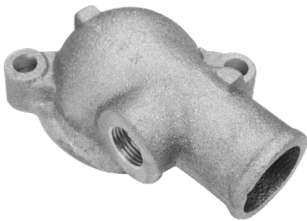

7072

NACIONAL FORD 200, FALCON BRONCO 6 CIL 144, 200	60/72
--	-------

AMERICANA FORD TODOS L-6 MAQ 144, 170 y 200 2.8 y 3.3L MERCURY	66/74 60/83
--	----------------

No. Original: C1DZ-8592-B,
C8DZ-8592-A, C1DZ-8592-C



7074

AMERICANA

FORD TODOS MAQ 390, 410, 427, 428, 428CJV-8, F100, 350 V-8 MAQ 360, 390 MERCURY	66/73 73/76 67/70
--	-------------------------

No. Original: C4TZ-8592-C,
C7AZ-8592-A

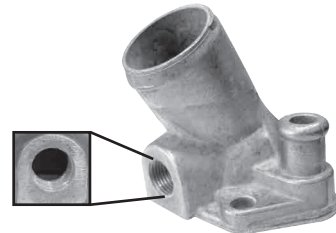

7079

NACIONAL Y AMERICANO

*CON ENTRADA DE VÁLVULA
DIFUSORA DE TEMPERATURA*

ALL FORD MUSTANG ENG. 289, 302 & 351 W, CROWN VICTORIA, CUSTOM 5.8L, GALIXE & LTD V 8	68/81 86/91
LINCOLN TOWN CAR 302 (5.0) & 351 FORD V-8	86/91 62/UP

No. Original: C90Z-8592-B
C30Z-8592-A
Ref.: 1592



7080

NACIONAL

FALCON F 100 6 CIL MAQ. 250	68/84
-----------------------------	-------

AMERICANA

FORD y MERCURY TODOS L-6 250 4.1L SIN A/C	68/84
--	-------

No. Original: C9DZ-8592-B,
C8DZ-8592-B, C9DZ-8592-A



7081

NACIONAL FALCON, F 100 6 CIL 250	68/84
--	-------

AMERICANA FORD y MERCURY TODOS L-6 250 4.1L CON A/C	68/84
--	-------

No. Original: C9DZ-8592-A

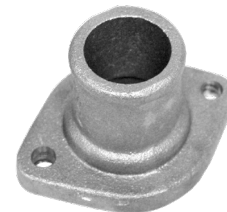

7091

AMERICANA

FORD SERIES E-F 100/350 ECONOLINE, VAN y PICK-UP FORD y MERCURY MAQ 351 y 400 5.8, 6.6 y 7.5L	75/76 TODOS
--	----------------

No. Original: D1AZ-8592-A,
D0AZ-8592-A

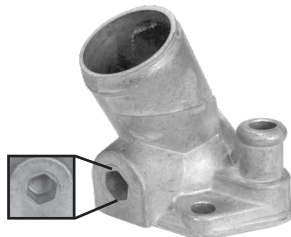

7089

AMERICANA

FORD V-8 MAQ 302, 335, 351 F100, 150, 250, 350 y 600	62/92
---	-------

No. Original: C90Z-8592-A,
74ZY-8592-AA
Ref.: 1592-B

TOMAS DE AGUA

FORD: MERCURY-LINCOLN



TOMAS DE AGUA



7102

AMERICANA

FORD SERIES E-F 100/350 ECONOLINE, VAN y PICK-UP FORD y MERCURY TODOS MAQ 351C, 351M 400 V-8 5.8, 6.6, y 7.5L	75/79 74/76
---	----------------

No. Original: D5AZ-8592-A
D4AZ-8592-A



7107

AMERICANA

FORD y MERCURY TODOS FRENTE BAJO V-6 MAQ 171 2.8L	74/79
---	-------

No. Original: D4ZZ-8592-C



7112

AMERICANA

FORD V-6 MAQ. 171 2.8L FORD y MERCURY TODOS	74/76 71/79
--	----------------

No. Original: D5FZ-8592-A,
D6FZ-8592-A

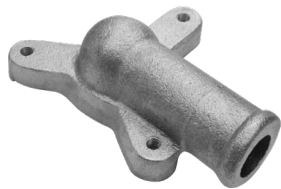

7113

AMERICANA

ALL FORD (2800CC) ENGINE, LOWER FRONT; ALL MERCURY (2.8L) (2800CC) ENGINE, LOWER FRONT ALL MERCURY (2600CC) ENGINE, LOWER REAR 2.8L V6	74/79
---	-------

No. Original: D2RY-8592-C



7118

NACIONAL

THUNDERBIRD, COUGAR MICROBUS TBI V-8 302, 351 MAQ. 302 5.0L	90/94 92/02
---	----------------

AMERICANA

FORD E 100/350 ECONOLINE VAN 351 y 400 MUSTANG 4.2 y 5.8L EXPLORER y LOBO; F100 PICK UP LINCOLN CONTINENTAL & MARK VII FORD LINCOLN MERCURY MAQ. 351 5.7L	75/79 74/89 81/83 86/91 74/01 86/92 80/01
--	---

No. Original: D5TZ-8592-A,
F0ZZ-8592-A



7123

NACIONAL

MARQUIZ, CROWN VICTORIA LTD 351, 400, BRONCO 351M y 400 CAÑON CORTO 5.8 y 6.6L	77/79
--	-------

AMERICANA

ALL FORD, F 100/350 PICKUP LINCOLN y MERCURY ALL FORD BRONCO 8 CIL	77/79 78/79
--	----------------

No. Original: D7AZ-8592-A



7117

AMERICANA

TOPAZ TEMPO PINTO SIN AIRE ACONDICIONADO RANGER, COURIER 140 2.3L FORD y MERCURY 4 CIL	74/82 74/78
---	----------------

No. Original: D4FZ-8592-A



TOMAS DE AGUA

FORD: MERCURY-LINCOLN

TOMAS DE AGUA



7124

AMERICANA

FORD 429 LINCOLN, MERCURY ECONOLINE 429 y 460 V-8 7.5L	68/79 73/74
--	----------------

No. Original: D6RY-8592-A, D6FZ-8592-A



7125

AMERICANA

FORD 429 LINCOLN, MERCURY ECONOLINE 429 y 460 V-8 7.5L	68/79 73/74
--	----------------

No. Original: D7VY-8592-A, C8SZ-8592-A



7128

AMERICANA

FORD SERIES E-F 100/350 ECONOLINE VAN y PICK-UP P 600 STEP VAN Y PARCEL DELIVERY V-8 MAQ. 300 Y 240	73/79 78
---	-------------

No. Original: D37Z-8592-A



7130

AMERICANA

FORD FIESTA W/O A/C 1.6L, 4 CIL	78/80
---------------------------------	-------

No. Original: D8RZ -8592-A



7152

AMERICANA

TOPAZ TEMPO, PINTO CON A/A MAQ. 140 2.3L	78/88
RANGER 4 CIL C/A ALL FORD & MERCURY , EXCEPT HSCC	78/82
ALL FORD y MERCURY , EXCEPT FORD TEMPO y MERCURY TOPAZ LPG	86/88 83/85

No. Original: D8FZ-8592-A



7166

AMERICANA

FORD BRONCO, ECONOLINE, F-100 MAQ 351 y 400 CAÑON LARGO	80/81
F-150	80/81
F-250 y F-350	80/82
E-100, E-150, E-250 y E-350 ECONOLINE	80/82

No. Original: E0TZ-8592-A



7136

AMERICANA

FORD F 100, 350, ECONOLINE, PICK-UP 460 7.5L CALIFORNIA	78/85 86/87
---	----------------

No. Original: E5TZ-8592-C, D8TZ-8592-A

TOMAS DE AGUA

FORD: MERCURY-LINCOLN



TOMAS DE AGUA



7168

NACIONAL BRONCO, E-150 ECONOLINE, F100, 150, 250, 350 4.9L, 6 CIL (CARBURADO)	80/87
AMERICANA BRONCO 6L 4.9L E-150, 250, 350, ECONOLINE 6L (4.9L) F-100, 350 PICK-UP 250 4.9L, 6 CIL	85/86 73/82 74/83
No. Original: E0TZ-8592-B	



7202

NACIONAL COUGAR Y THUNDERBIRD F-150 y F-200	85/UP 86/UP
AMERICANA MUSTANG 3.8L, 6 CIL MERCURY V-6 230 3.8L F-100 PICK UP V6 LINCOLN TODOS	80/88 80/88 82/84 80/87
No. Original: E2DZ-8592-A E3DE-8592-A Ref.: 6592	



7217

NACIONAL 4 CIL 140 2.3L ESCORT 2.0L, MERCURY LYNIX, LN7 y TOPAZ 2.0L	84/88
AMERICANA FORD TEMPO Y MERCURY TOPAZ	84/UP
No. Original: E43Z-8592-A Ref.: 4594	



7219

AMERICANA FORD MUSTANG y MERCURY CAPRI V-6 230 3.8L	85
No. Original: E3ZZ-8592-A	



7220

AMERICANA FORD BRONCO II y RANGER LADO FRONTAL 6 CIL 2.8L	83/85
No. Original: E4TZ-8592-L, E3TZ-8592-L	



7222

AMERICANA FORD y MERCURY TODOS EXCEPT TURBO, FORD TEMPO y MERCURY, TOPAZ MAQ 140 4 CIL	83/91
No. Original: E3BZ-8592-A	



TOMAS DE AGUA

FORD: MERCURY-LINCOLN

TOMAS DE AGUA



7223

AMERICANA

BRONCO II y RANGER	83/88
AEROSTAR 2.0, 2.3L, 4 CIL	
F 100 350 6 CIL	84/87

No. Original: E4TZ-8592-B



7258

NACIONAL

BRONCO, E-150 ECONOLINE, F150, 250, 350 4.9L, 6 CIL (F.I.)	85/90
CON ENTRADA PARA BULBO	

AMERICANA

BRONCO 6L 4.9L	80/84
E-150 ECONOLINE 6 CIL M-240-300	5/90
F-150 PICK-UP 6 CIL	85/89
F-250 PICK-UP 6 CIL	85/87
F-350 PICK-UP 6 CIL	85/89

No. Original: E5TZ-8592-E, E7TZ-8592-B

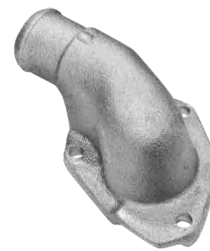

7261

AMERICANA

BRONCO II, RANGER 2.9L, 6 CIL	86/92
-------------------------------	-------

No. Original: E6TZ-8592-A



7262

AMERICANA

F 250, 350 VAN, PICK-UP EXCEP CALIFORNIA 460 V-8	86/87
--	-------

No. Original: E5TZ-8592-D



7264

NACIONAL

FORD V6 MOTOR 230 3.8L TAURUS	84/88
-------------------------------	-------

AMERICANA

AEROSTAR 3.0L, TAURUS, MERCURY SABLE 3.8L V-6 (ALTURA: 53.16 MM)	86/93
--	-------

No. Original: E8DZ-8592-B, E69Z-8592-A Ref.: 8594



7268

NACIONAL

BRONCO, E-150 ECONOLINE, F100, 150, 250, 350 4.9L, 6 CIL (F.I.) SIN ENTRADA PARA BULBO	90/97
--	-------

AMERICANA

F-150, 250, 350, PICK-UP 4.9L, 6 CIL	91/96 90/97
--------------------------------------	----------------

No. Original: F0TZ-8592-H, F5TZ-8592-BA



7263

AMERICANA

TEMPO, TOPAZ, TAURUS EXCEP SUPER HIGH OUTPUT, SABLE, PROBE 3.0L V-6	86/94
FORD y MERCURY	86/95

No. Original: E8DZ-8592-A

TOMAS DE AGUA

FORD: MERCURY-LINCOLN



TOMAS DE AGUA



7269

NACIONAL

TOPAZ FI 2.2 y 2.3L, 4 CIL
C/DOBLE BARRENO PARA BULBO DE
MOTOVENTILADOR Y TEMP.
(CARBURADO)

89/91

AMERICANA

FORD TEMPO & MERCURY
TODOS 2.3L, 4 CIL

88/94

No. Original: E93Z-8592-A



7270

NACIONAL

F 150, 350 ECONOLINE VAN,
PICK-UP 8 CIL
WINDSTAR 6 CIL

97/00

97/05

AMERICANA

F 150/350 ECONOLINE VAN &
PICKUP TRUCK 8 CIL

97/00

No. Original: F75Z-8592-CA

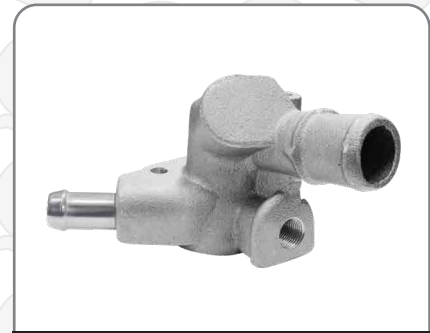

7271

NACIONAL

TOPAZ FI 2.2L y 2.3L, 4 CIL
C/UN BARRENO PARA BULBO
DE TEMPERATURA

92/94

AMERICANA

TEMPO & TOPAZ 2.3L 4 CIL

92/94

No. Original: F23Z-8592-A



7272

NACIONAL

ESCORT ZX2 1.8, 1.9 y 2.0L, 4 CIL

98/03

AMERICANA

ZX2 2.0L, 4 CIL

00/03

No. Original: XS4Z-8592-TB



7273

**NACIONAL
HOUSING**

FOCUS DOS ÁRBOLES 16V 2.0L, 4 CIL

00/04

CONTOUR y MYSTIQUE,
COUGAR 2.0L 4 CIL
ESCAPE
FOCUS
FOCUS LE
S2

00
00/02
01/04
02/04
00
02

No. Original: YS4Z-8592-BD Ref.: 9199

APLICA PARA TOMA DE AGUA 7280

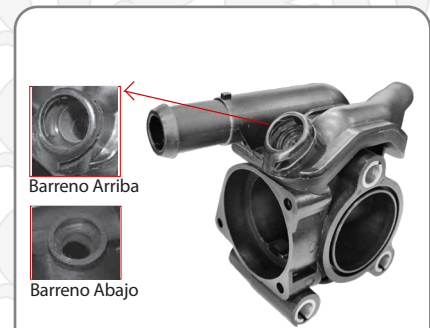

7273-H

**Nacional y Americana
HOUSING**

(CON BARRENOS PARA SENSOR DE
TEMPERATURA A PRESIÓN Y DE
MOTOVENTILADOR)

FOCUS UN ÁRBOL SPY 16V, 2.0L

02/03

No. Original: YS4Z-8592-AD

APLICA PARA TOMA DE AGUA 7280



TOMAS DE AGUA

FORD

TOMAS DE AGUA



7274

NACIONAL Y AMERICANA

FIESTA, IKON y KA
1.4 y 1.6L, 4 CIL
(TORTUGA) TODOS

No. Original: XS6E-8A586-AL,
XS6E-8250-AD



7274-A

NACIONAL Y AMERICANA

FIESTA, IKON y KA 1.4 y 1.6L,
4 CIL
ALUMINIO (TORTUGA) TODOS

No. Original: XS6E-8A586-AL,
XS6E-8250-AD

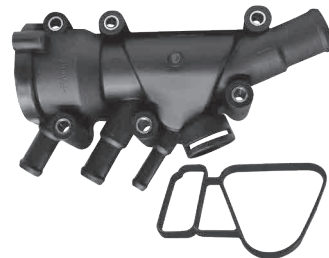

7274H

REF. 7274H-E

NACIONAL Y AMERICANA

HOUSING (CON JUNTA)
FIESTA, IKON y KA
1.4 y 1.6L 4 CIL (7274) TODOS
COURIER (7275)

No. Original: 5S6G-9K478-AA

SENSOR S-815

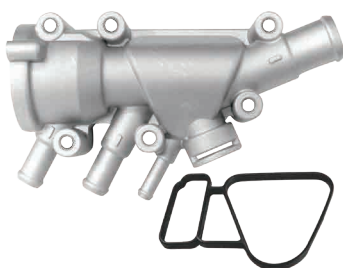

7274H-A

NACIONAL Y AMERICANA

HOUSING (CON JUNTA)
FIESTA, IKON y KA
1.4 y 1.6L, 4 CIL (7274) TODOS
Courier (7275) ALUMINIO

No. Original: 5S6G-9K478-AA

SENSOR S-815



7274H-T

NACIONAL Y AMERICANA

HOUSING
(CON JUNTA Y TERMOSTATO)
FIESTA, IKON y KA 4 CIL 1.4 Y 1.6L
(7274) TODOS
COURIER (7275)

No. Original: 2S6G-8A586-D1C

SENSOR S-815



7274/KIT

REF. 7274-KIT

NACIONAL Y AMERICANA

FIESTA, IKON y KA
1.4 y 1.6L, 4 CIL TODOS
HOUSING, TOMA DE AGUA,
TERMOSTATO, JUNTA,
O-RING, SENSOR Y SEGURO DE
SENSOR
(TORTUGA)

No. Original: XS6E-8A586-AL

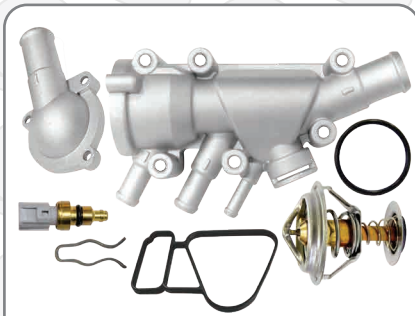

7274/KIT-A

REF. 7274-KIT-A

NACIONAL Y AMERICANA

FIESTA, IKON y KA
1.4 y 1.6L, 4CIL,
**(HOUSING, TOMA DE AGUA,
TERMOSTATO ,JUNTA, O-RING,
SENSOR Y SEGURO DE SENSOR)**
(TORTUGA)

ALUMINIO

TODOS

No. Original: XS6E-8A586-AL

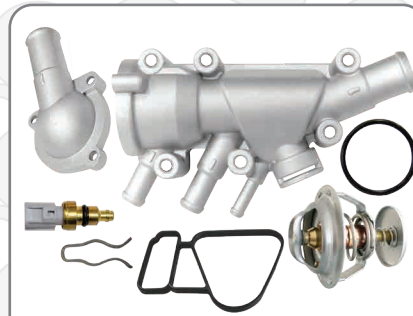

7274/KIT-A-1

REF. 7274-KIT-A-1

NACIONAL Y AMERICANA

FIESTA, IKON y KA
1.4 y 1.6L, 4CIL
**(HOUSING, TOMA DE AGUA,
TERMOSTATO ORIGINAL (BRASIL),
JUNTA, O-RING, SENSOR Y
SEGURO DE SENSOR)**
(TORTUGA)

ALUMINIO

TODOS

No. Original: XS6E-8A586-AL



S-815

NACIONAL Y AMERICANA
SENSOR DE TEMPERATURA (A PRESIÓN)

FIESTA, IKON y KA
1.4L y 1.6L, 4 CIL
FORD COURIER 1.6L, 4 CIL

TODOS

TODOS

No. Original: XS6F-12A648-BA
Ref.: 815

**APLICA PARA: 7274-H,
7274-H-E, 7274H-A, 7274-H-T**



PRECIO ESPECIAL

T-7274

Ref.: 2265.82

TERMOSTATO (BRASIL)

FIESTA, IKON, KA y COURIER

TODOS

No. Original: 1254371

APLICA PARA: 7274-H, 7274-H-T



T-7274-E

REF.: 2265.82-E

**TERMOSTATO
AMERICANO (ECONÓMICO)**

FIESTA, IKON, KA y COURIER

TODOS

No. Original: 1254371

APLICA PARA: 7274-H, 7274-H-T



7275

NACIONAL Y AMERICANA

COURIER 1.6L, 4 CIL
(CUELLO EN U, TIPO ALACRÁN)

TODOS

No. Original: 2S6G-8250-A1B



TOMAS DE AGUA

FORD

TOMAS DE AGUA



7275-A

NACIONAL Y AMERICANA

COURIER 1.6, 4 CIL
(CUELLO EN U, TIPO ALACRÁN)
ALUMINIO

TODOS

No. Original: 2S6G-8250-A1B



7275/KIT

Ref. 7275-KIT
NACIONAL Y AMERICANA

COURIER 1.6L, 4 CIL
(HOUSING, TOMA DE AGUA,
JUNTA, TERMOSTATO, O'RING,
SENSOR Y SEGURO DE SENSOR)
(ALACRAN)

TODOS

No. Original: 2S6G-8A586-D1C

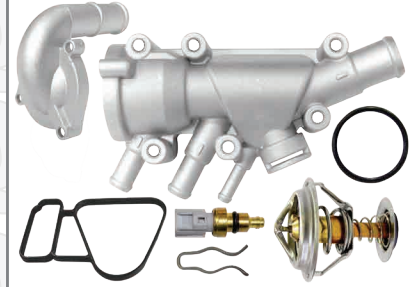

7275/KIT-A

Ref. 7275-KIT-A
NACIONAL Y AMERICANA

COURIER 1.6L, 4 CIL
(HOUSING, TOMA DE AGUA,
JUNTA, TERMOSTATO, O'RING,
SENSOR Y
SEGURO DE SENSOR)
ALUMINIO
(ALACRAN)

TODOS

No. Original: 2S6G-8A586-D1C

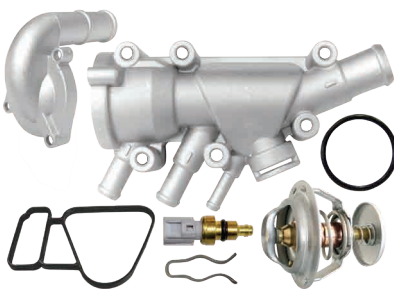

7275/KIT-A-1

Ref. 7275-KIT-A-1
NACIONAL Y AMERICANA

COURIER 1.6L, 4 CIL
(HOUSING,
TOMA DE AGUA, JUNTA,
TERMOSTATO ORIGINAL (BRASIL),
O'RING, SENSOR y
SEGURO DE SENSOR)
ALUMINIO

TODOS

No. Original: 2S6G-8A586-D1C



7274-75-KIT-E

**NACIONAL Y AMERICANA
ECONÓMICO**

FIESTA, IKON y KA 4 CIL 1.4 y 1.6L
COURIER 1.6L, 4CIL
(ALACRÁN y TORTUGA)
(HOUSING, TOMA DE AGUA (2),
JUNTA, TERMOSTATO, O'RING,
SENSOR y SEGURO DE SENSOR)

TODOS

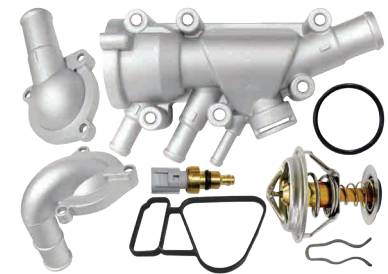

7274-75-KIT-A

NACIONAL Y AMERICANA

FIESTA, IKON, KA y COURIER
1.6L, 4 CIL
(ALACRÁN y TORTUGA)
(HOUSING, TOMA DE AGUA (2),
JUNTA, TERMOSTATO, O'RING,
SENSOR y SEGURO DE SENSOR)
ALUMINIO

TODOS

TOMAS DE AGUA

FORD



TOMAS DE AGUA

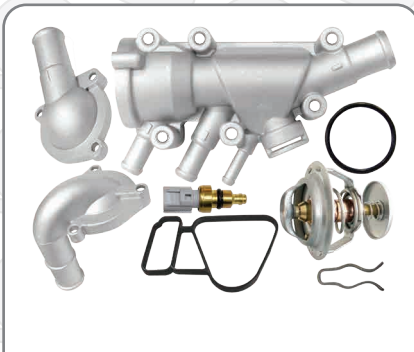

7274-75-KIT-A-1

NACIONAL Y AMERICANA

FIESTA, IKON, KA y COURIER 1.6L, 4 CIL TODOS
(ALACRÁN y TORTUGA)
(HOUSING, TOMA DE AGUA (2), JUNTA, O'RING, SENSOR TERMOSTATO ORIGINAL (BRASIL), y SEGURO DE SENSOR)
 ALUMINIO

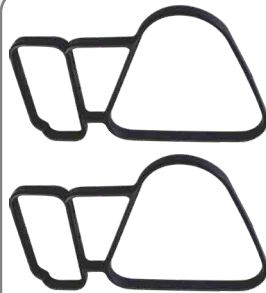

8255-BE ORIGINAL

8255-BE-E ECONÓMICA

JUNTA PARA HOUSING FORD

FIESTA, IKON y KA (7274/KIT) TODOS
 EN TODAS SUS VERSIONES
 COURIER (7275/KIT)
 EN TODAS SUS VERSIONES

No. Original: XS6E-8255-BE

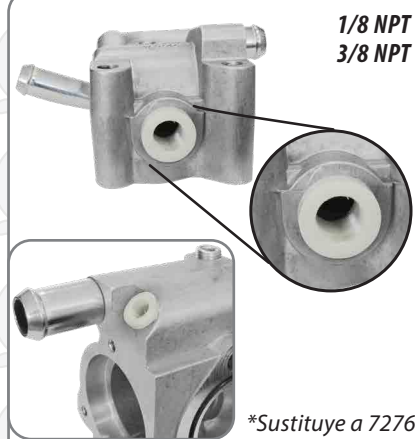

1/8 NPT
3/8 NPT

*Sustituye a 7276

7276-A

HOUSING ALUMINIO

NACIONAL
 CONTOUR y MYSTIQUE 2.5L, 4 y 6 CIL 95/99

AMERICANA
 CONTOUR 99
 ESCORT 98/99
 COUGAR, MYSTIQUE 2.0L 99

No. Original: F5RZ-8592-B

APLICA PARA TOMA DE AGUA 7277



7277

NACIONAL
 CONTOUR, MYSTIQUE 2.5L, 4 y 6 CIL 95/01

AMERICANA
 CONTOUR, MYSTIQUE 2.0L 4 y 6 CIL MERCURY 95/00

No. Original: F5RZ-8592-A
 Ref.: 9137

APLICA PARA HOUSING 7276-A



7277/KIT

Ref. 7277-KIT
NACIONAL Y AMERICANA

CONTOUR, MYSTIQUE 2.0 4 y 6 CIL 95/01
(HOUSING 7276-A y TOMA DE AGUA 7277)

No. Original:
 F5RZ-8592-B, F5RZ-8592-A



7278

NACIONAL Y AMERICANA

RANGER 2.3L, 4 CIL 93/97
 C/ENTRADA P/ SENSOR

No. Original: F2TZ-8592-AA



TOMAS DE AGUA

FORD

TOMAS DE AGUA



7279

NACIONAL RANGER 3.0L, 6 CIL	91/95
---------------------------------------	-------

AMERICANA RANGER 3.0L, 6 CIL RANGER EDGE 3.6L, 6 CIL FORD	00/01 '01 91/01
---	-----------------------

No. Original: XL5Z-8592-AB Ref.: 9146



7280/KIT

Ref. 7280-KIT NACIONAL	
FOCUS 16V 2.0L, 4 CIL ESCAPE 2.0L, 4 CIL (HOUSING 7273 Y TOMA DE AGUA 7280)	00/04 01/04

No. Original: YS4Z-8592-BD
YS4Z-8592-AC



7282

NACIONAL RANGER 4.0L, 6 CIL MOTOR OHV 35 MILIMETROS	90/00
--	-------

AMERICANA RANGER, EXPLORER 4.0L, 6 CIL FORD	'00 90/00
--	--------------

No. Original: F0TZ-8592-CA
Ref.: 9148

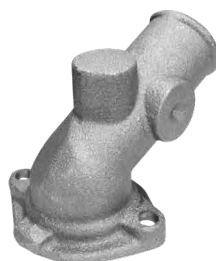

7281

NACIONAL Y AMERICANA	
RANGER 6V 3.0L	95/97

No. Original: F5TZ-8592-AA



7280

NACIONAL	
FOCUS 16V 2.0L, 4 CIL ESCAPE 2.0L, 4 CIL	00/04 01/04

AMERICANA ESCAPE 01/04 FOCUS S2, STREET SE, ZTS, ZX3 ZTW ZX5	01/04 01/02 02/03 02/04
---	----------------------------------

No. Original: XS4Z-8592-AC
Ref.: 9147

APLICA PARA HOUSING 7273



7283

NACIONAL Y AMERICANA (CON ENTRADA PARA SENSOR)	
RANGER 2.3L, 4 CIL	93/97

No. Original: F57Z-8592-AB



7284

NACIONAL WINDSTAR FREESTAR 3.8L, 6 CIL	03/07
--	-------

AMERICANA WINDSTAR 3.8L, 6 CIL FREESTAR y FREESTAR SE 3.9L, 6 CIL FREESTAR LIMITED y SEL 4.2L 6 CIL MERCURY MONTEREY 4.2L 6 CIL <i>(ALTURA: 57.26mm)</i>	96/03 07 07
--	-------------------

No. Original: F78Z-8592-BA,
F78Z-8592- BB



7285

NACIONAL
(CON SENSOR Y TERMOSTATO)
ECOSPORT 2.5L, 4 CIL
RANGER 2.0L, 4 CIL
MONDEO

04/UP
01/04
TODOS

AMERICANA
ECOSPORT CON SENSOR
2.5L, 4 CIL

04/UP

No. Original: 1S7Z-8575-AG
Ref.: 9149



7287

NACIONAL Y AMERICANA

ESCAPE 3.0L, 6 CIL

01/04

No. Original: YL8Z-8592-AB



7290

NACIONAL
EXPLORER 4.6L

89/04

AMERICANA
EXPLORER 4.0L, 6 CIL
MERCURY MOUNTAINEER 4.0L, 6 CIL
RANGER 4 CIL 4.0L

97/01
98/01
02/UP

No. Original: F7TZ-8594-A

APLICA PARA HOUSING 7295



7288

NACIONAL Y AMERICANA

ESCAPE 3.0L, 6 CIL

05/08

No. Original: 2M5Z-8592-CD



7286

CON TERMOSTATO SIN SENSOR

NACIONAL
ESCAPE 3.0L, 4 CIL
FUSIÓN 1.6L, 6 CIL
RANGER
ECOSPORT 2.0L, 4 CIL

07/10
07/12
04/08
03/12

AMERICANA
ESCAPE
ECOSPORT W/O
SENSOR 2.5L, 4 CIL.

07/10
03/12

No. Original: 3M4Z-8575-B
Ref.: 9150



7289

NACIONAL Y AMERICANA

ESCAPE 3.0L, 6 CIL

09

No. Original: 9L8Z-8592-A



7290/KIT

Ref. 7290-KIT
NACIONAL
ENTRADA PARA 2 SENSORES
CON ROSCA

EXPLORER 4.6L

89/04

AMERICANA
EXPLORER 4.0L, 6 CIL
MERCURY MOUNTAINEER 4.0L, 6 CIL
RANGER 4.0L, 4 CIL
(HOUSING 7295 Y TOMA DE AGUA 7290)

97/01
98/01
02/UP

No. Original: F7TZ-8594-A

**SENSOR S-648 y S-884
TERMOSTATO 2285.98**



TOMAS DE AGUA

FORD

TOMAS DE AGUA



7290-KIT-T-S

HOUSING: 7295
TOMA DE AGUA: 7290
SENSORES: S-648 y S-884
TERMOSTATO: T-2285.98

NACIONAL EXPLORER 4.6L	89/04
----------------------------------	-------

AMERICANA EXPLORER 4.0L, 6 CIL MERCURY MOUNTAINEER 4.0L, 6 CIL RANGER 4.0L, 4 CIL	97/01 98/01 02/UP
---	-------------------------

No. Original: F7TZ-8594-A



7291

NACIONAL CROWN VICTORIA GRAND MARQUIS 4.6L, 8 CIL	96/99
--	-------

AMERICANA TOWN CAR 4.6L, 8 CIL FORD LINCOLN	91/95 97/07 98/99
---	-------------------------

No. Original: F1VY-8592-AA



7292

NACIONAL ESCORT 16V, 4 CIL	98/99
--------------------------------------	-------

AMERICANA ZX2 2.0L, 4 CIL	
-------------------------------------	--

No. Original: F8RZ-8592-AC



7293

NACIONAL EXPLORER 4.0L RANGER 4 CIL	00/UP 97/01
--	----------------

AMERICANA EXPLORER EXPLORER SPORT MOUNTAINEER 4.0L, 6 CIL RANGER 3.0L, 6 CIL	01/05 01/03 01/04 02/04
---	----------------------------------

No. Original: 2L2Z-8592-AA

APLICA PARA HOUSING 7294

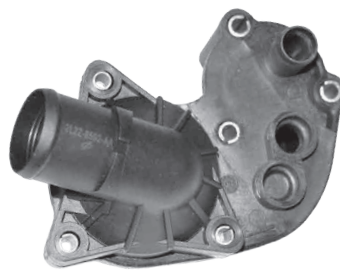

7293/KIT

Ref. 7293-KIT
NACIONAL
ENTRADA PARA UN SENSOR A PRESIÓN

EXPLORER 4.0L RANGER 4.0L, 4 CIL	00/UP 97/01
-------------------------------------	----------------

(HOUSING 7294 Y TOMA DE AGUA 7293)

No. Original: 2L2Z-8592-AA

SENSOR S-381 Y TERMOSTATO T-2285.98

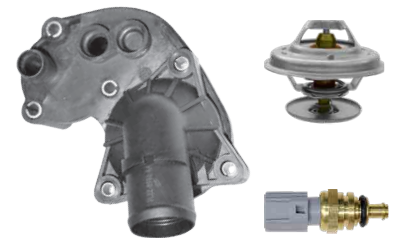

7293-KIT-T-S

HOUSING: 7294
TOMA DE AGUA: 7293
SENSOR: S-381
TERMOSTATO: T-2285.98

NACIONAL EXPLORER 4.0L RANGER 4.0L, 4 CIL	00/UP 97/01
--	----------------

No. Original: 2L2Z-8592-AA

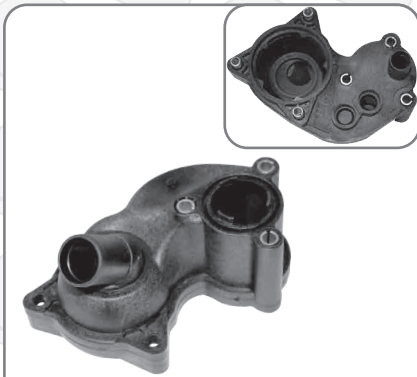

7294

HOUSING
ENTRADA PARA UN SENSOR A PRESIÓN

NACIONAL EXPLORER 4.0L RANGER 4.0L, 4 CIL MUSTANG V6 12V 4L, 8 CIL	00/UP 97/01 06/10
--	-------------------------

No. Original: 2L2Z-8592-BA

APLICA PARA T.A. 7293 y 7313
SENSOR S-381
TERMOSTATO T-2285.98



7295

HOUSING
ENTRADA PARA 2 SENSORES CON ROSCA

NACIONAL EXPLORER 4.6L RANGER 4.0L, 4 CIL	89/04 02/UP
--	----------------

AMERICANA EXPLORER MOUNTAINEER	97/00 02/UP
---	----------------

No. Original: 2L5Z-8592-BB

APLICA PARA T.A. 7290
SENSOR S-648 Y S-884
TERMOSTATO T-2285.98

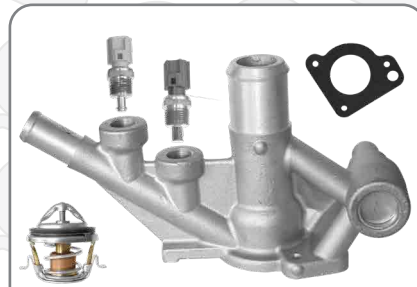

7296

NACIONAL
ESCORT 2.0L, 4 CIL
CON 2 SENSORES y TERMOSTATO

97/00

No. Original: F8CZ-8592-AA



7297

NACIONAL Y AMERICANA
CON 2 SENSORES Y TERMOSTATO

RANGER 2WD 2.3L, 4 CIL	89/91
------------------------	-------

No. Original: F87Z-8592-AM



7298-KIT

HOUSING, TAPON Y TERMOSTATO

THUNDERBIRD V8, 3.9L LINCOLN LS V8, 3.9L	03/05 03/06
---	----------------

No. Original: 3W4Z-8548-AD



7299

NACIONAL Y AMERICANA
CON TERMOSTATO

E-300, 350 y 450 ECONOLINE V8, 6.0L	04/05
E-350 SUPER DUTY V8, 6.0L	06/08
EXCURSION V8, 6.0L	03/05
F250 y 350 V8, 6.0L	03/07
F450, 500 y 550 PICK-UP V8, 6.0L	05/07
F450, SUPER DUTY V8, 6.0L (ALTURA: 78.75mm)	03/04

No. Original: 3C3Z-8575-AA



7298

NACIONAL Y AMERICANA
CON TERMOSTATO

THUNDERBIRD V8, 3.9L LINCOLN LS V8, 3.9L	03/05 03/06
---	----------------

No. Original: 3W4Z-8592-AA



TOMAS DE AGUA

FORD

TOMAS DE AGUA



7300

NACIONAL Y AMERICANA CON TERMOSTATO, SENSOR Y SEGURO	
FOCUS 2.0L, 4 CIL (1 ÁRBOL)	01/03
No. Original: 2M5Z-8592-AC	



7301

NACIONAL	
MUSTANG COBRA, GT V8, 4.6L	96/03
COUGAR V6, 2.5L	99/02
SABLE 3.0L	01/02
CONTOUR V6, 2.5L	98/00
MYSTIQUE V6, 2.5L	99/00
AMERICANA	
CONTOUR SVT 00	00
COBRA	01/04
MACH1	03/04
TAURUS	01/05
LINCOLN LS	00/05
COUGAR	00/02
MARAUDER	03/04
MYSTIQUE	00
SABLE	00/05
LINCOLN y MERCURY	96/05
No. Original: F6ZZ-8592-BB	



7302

NACIONAL	
V8 4.6L, CROWN VICTORIA	99/03
GRAND MARQUIS	98/03
MUSTANG GT, COBRA	96/03
THUNDERBIRD, COUGAR	96/97
AMERICANA	
MUSTANG GT 4.6L, 8 CIL	'00
MUSTANG BULLITT, GT 8 CIL,	'01
MERCURY	96/97
No. Original: F6ZZ-8592-C	

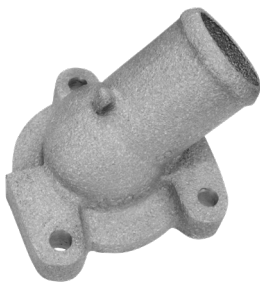

7303

NACIONAL	
TAURUS V6 3.0L	1999
TAURUS G/GL/LX, SABLE	96/03
AEROSTAR, RANGER/SUPER	96/97
AMERICANA	
TAURUS y SABLE	00/05
TAURUS SE y SEL CIL 3.0L,	06/76
MERCURY	96/05
SUBARU	78/79
No. Original: YF1Z-8592-CA	



7304

NACIONAL	
EXPEDITION MOTOR V8 24V	04/08
5.7L, 8 CIL (SIN ORIFICIO)	
No. Original: 3L3Z-8592-AA	



7305

NACIONAL	
ECONOLINE	00/04
EXCURSION	01/05
F-250, F-350, F-450 y F-550	04/09
10L, 8 CIL	
AMERICANA	
E SUPER DUTY	00/02
E 350 ECONOLINE, EXCURSION,	00/03
F-250/350/450/550,	
SUPER DUTY PICK UP	
E450 ECONOLINE, E550 SUPER	03
DUTY CUSTOM	
No. Original: F81Z-8592-AA	



7306

NACIONAL ECONOLINE 7.3L, 8 CIL	00/04
AMERICANA E-350 ECONOLINE SUPER DUTY F250/350 SUPER DUTY 7.3L, 8 CIL	94/03 96/99 94/97

No. Original: F4TZ-8592-AA



7307

NACIONAL COUGAR MUSTANG THUNDERBIRD 3.8L, 6 CIL	80/96 80/00 80/96
--	-------------------------

No. Original: E9SZ-8592-B, F2SZ-8592-A



7310/KIT

Ref. 7310-KIT
HOUSING 7311 Y T.A. 7310
(ENTRADA 2 SENSORES A PRESIÓN)

NACIONAL EXPLORER 5.0L, 8 CIL.	07/10
EXPLORER MOUNTAINEER 5.0L, 8 CIL.	07/10
MUSTANG 5.0L, 8 CIL	05/10
EXPLORER SPORT TU 5.0L, 8 CIL	01/03

No. Original: 2L2Z-8592-BA,
2L5Z-8592-BB

-SENSOR S-381 Y S-311 TERMOSTATO
T-2285.98



7309

NACIONAL FIESTA 1.3 y 1.4L, 4 CIL	95/98
---	-------

No. Original: 98MM-9K478-DA
98MM-9K478-DB



7308

NACIONAL ESCAPE 4.0L, 6 CIL FUSION 3.8L, 6 CIL	03/07 06/07
AMERICANA FORD ESCAPE FUSION MERCURY MARINER MERCURY MILAN 6 CIL 3.0L	01/07 06/07 07 06/07

No. Original: YL8Z-8K528-AE



7310

NACIONAL EXPLORER SPORT TU 5.0L, 8 CIL	01/03
--	-------

No. Original: 2L5Z-8592-BB

APLICA PARA HOUSING 7311



7310-KIT-T-S

HOUSING: 7311
TOMA DE AGUA: 7310
SENSORES: S-381 y S-311
TERMOSTATO: T-2285.98
(ENTRADA 2 SENSORES A PRESIÓN)

NACIONAL EXPLORER 5.0L, 8 CIL.	07/10
EXPLORER MOUNTAINEER 5.0L, 8 CIL.	07/10
MUSTANG 5.0L, 8 CIL	05/10
EXPLORER SPORT TU 5.0L, 8 CIL	01/03

No. Original: 2L2Z-8592-BA,
2L5Z-8592-BB



TOMAS DE AGUA

FORD

TOMAS DE AGUA



7311

**HOUSING PARA T.A. 7310 Y 7312
(ENTRADA 2 SENSORES A PRESIÓN)**

NACIONAL

EXPLORER 5.0L, 8 CIL. 07/10
EXPLORER MOUNTAINEER 5.0L, 8 CIL. 07/10
MUSTANG 5.0L, 8CIL 05/10

No. Original: 2L2Z-8592-BA

**-SENSOR S-381 y S-311 TERMOSTATO
T-2285.98**



7312

NACIONAL

RANGER 3.0L, 6 CIL 03/07

No. Original: 4L5Z-8592-AA

APLICA PARA HOUSING 7311



7313

NACIONAL

EXPLORER SPORT TRACK 06/10
4.0L, 6 CIL

No. Original: 6L2Z-8592-FA

APLICA PARA HOUSING 7294



7312/KIT

Ref. 7312-KIT

**HOUSING 7311 y T.A. 7312
(ENTRADA 2 SENSORES A PRESIÓN)**

RANGER 3.0L, 6 CIL 03/07
EXPLORER 5.0L, 8 CIL. 07/10
EXPLORER MOUNTAINEER 5.0L, 8 CIL. 07/10
MUSTANG 5.0L, 8 CIL 05/10

No. Original: 2L2Z-8592-BA,
4L5Z-8592-AA

**-SENSOR S-381 y S-311
TERMOSTATO T-2285.98**

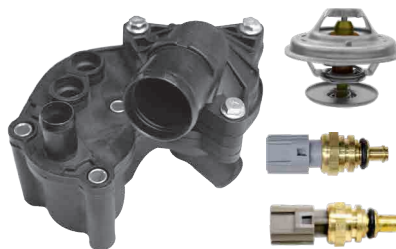

7312-KIT-T-S

**HOUSING: 7311
TOMA DE AGUA: 7312
SENSORES: S-311 y S-381
TERMOSTATO: T-2285.98
(ENTRADA 2 SENSORES A PRESIÓN)**

RANGER 3.0L, 6 CIL 03/07
EXPLORER 5.0L, 8 CIL 07/10
EXPLORER MOUNTAINEER 5.0L, 8 CIL 07/10
MUSTANG 5.0L, 8 CIL 05/10

No. Original: 2L2Z-8592-BA,
4L5Z-8592-AA



7313/KIT

Ref. 7313-KIT

**(HOUSING 7294 y T.A. 7313)
(ENTRADA PARA UN SENSOR A PRESIÓN)**

EXPLORER SPORT TRACK 4.0L, 6 CIL 06/10
EXPLORER 4.0L 00/UP
RANGER 4 CIL 4.0L 97/01
MUSTANG V6 12V 4.0L, 8 CIL 06/10

No. Original: 6L2Z-8592-FA,
2L2Z-8592-BA

**-SENSOR S-381
TERMOSTATO T-2285.98**



7313-KIT-T-S

HOUSING: 7294
TOMA DE AGUA: 7313
SENSOR: S-381
TERMOSTATO: T-2285.98
(ENTRADA 1 SENSOR A PRESIÓN)

EXPLORER SPORT TRACK 4.0L, 6 CIL	06/10
EXPLORER 4.0L	00/UP
RANGER 4 CIL 4.0L	97/01
MUSTANG V6 12V 4.0L, 8 CIL	06/10

No. Original: 6L2Z-8592-FA,
2L2Z-8592-BA



7314

NACIONAL

EXPEDITION 5.4L, 8 CIL, 16V
 F150 4.6L, 8 CIL
 (CON ORIFICIO)

02/06
98/UP

No. Original: F65E-8594-BA
 F65Z-8592-BD



7315

NACIONAL

FOCUS EUROPEO 2.0L, 4 CIL, 16V

09/14

No. Original: 4M5G-89575-GA



7316

NACIONAL

MUSTANG 3.8L, 6 CIL, 12V

00/04

AMERICANA

MUSTANG 3.8 L 6 CIL

99/04

No. Original: XR3Z-8592-AA



7317

CON TERMOSTATO

NACIONAL

EXPLORER 2.0L, 4 CIL, 16V
 EDGE 2.0L, 4 CIL, 16V
 ESCAPE 2.0L, 4 CIL, 16V
 RANGER 2.0L, 4 CIL

11/13
07/13
09/UP
09/UP

No. Original: AG9Z-8575-B

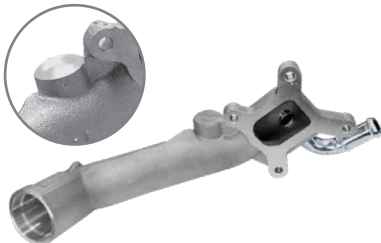

7318

NACIONAL
(SIN ENTRADA PARA SENSOR)

RANGER ARGENTINA 2.3L, 4 CIL

02/06

No. Original: 1L5Z-8K556-AF

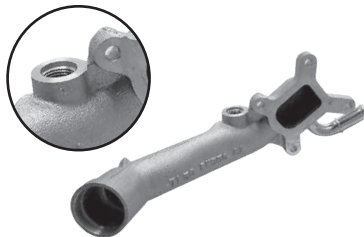

7319

NACIONAL
(CON ENTRADA PARA SENSOR)

RANGER ARGENTINA 2.3L, 4 CIL

06/12

No. Original: 7L5Z-8K556-A



7320

ECOSPORT, FOCUS, FIGO
 FIESTA 1.6L, 4 CIL

08/14
98/01

No. Original: 7M5G-8K556-AC



TOMAS DE AGUA

FORD

TOMAS DE AGUA

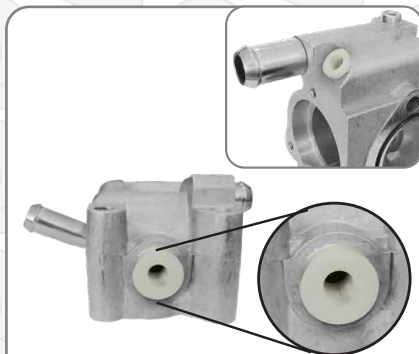

7321

HOUSING ALUMINIO (1/8 NPT M12 x 1.5)	
CONTOUR, MYSTIQUE 2.0L, 4 y 6 CIL	00/04
No. Original: F5RZ-8592-B	



7321-KIT

HOUSING CONTOUR Y MISTIQUE 2.0L 4 CIL y 6 CIL	00/04
CONTOUR, MYSTIQUE 2.5L 4 y 6 CIL.	95/01
CONTOUR, MYSTIQUE 2.0L 4 y 6 CIL.	95/00
MERCURY	
(HOUSING ALUMINIO 7321 y T/A 7277)	
No. Original: F5RZ-8592-B, F5RZ-8592-A	



7322

ECOSPORT 2.0L, 4 CIL	13/UP
DURATEC	
No. Original: 1450955	



7323

F-250, F-350, F-450-F550 SUPER DUTY 6.7L, 8 CIL. DIESEL	11/16
No. Original: BC3Z-8592-A	



NUEVO

7324

MUSTANG 5.2 y 5.0L 8 CIL	14/15
No. Original: BR3Z-8A586-M	



NUEVO

7325

F-450 DIESEL 6.4 L, 8 CIL	06/10
No. Original: 8C3Z-8592-N	



NUEVO

7326-1

CON TERMOSTATO	
FIESTA 1.6L, 4 CIL SIGMA	13/17
FUSION 2.0L, 4 CIL ECOBOOST	11/14
No. Original: BM5Z-8592-B BM5G-9K478-AB	



S-311

SENSOR A PRESIÓN

Ref.: 311

EXPLORER 5.0L, 8CIL	07/10
EXPLORER MOUNTAINEER 5.0L, 8CIL	07/10
MUSTANG 5.0L, 8 CIL	05/10
EXPLORER SPORT TU 5.0L, 8 CIL	01/03
RANGER 3.0L, 6CIL	03/07

No. Original: 3F1Z-0884-AA

**APLICA PARA: 7310/KIT
Y 7312/KIT**

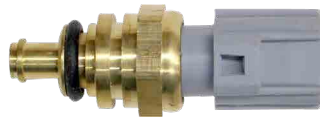

S-381

SENSOR A PRESION

Ref.: 381

EXPLORER 4.0L	00/UP
RANGER 4.0L, 4 CIL	97/01
EXPLORER SPORT TRACK 4.0L, 6 CIL	06/10
MUSTANG V6 12V 4L, 8 CIL	06/10

AMERICANA

EXPLORER	01/05
EXPLORER SPORT	01/03
MOUNTAINEER 4.0L, 6 CIL	01/04
RANGER 3.0L, 6 CIL	02/04

No. Original: 3L8Z-12A648-BA

**APLICA PARA: 7293/KIT,
7310/KIT, 7312/KIT Y 7313/KIT**

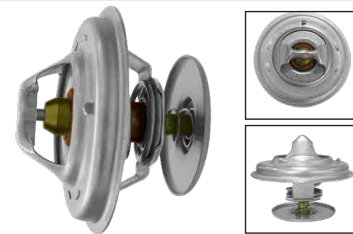

T-2285.98

TERMOSTATO

REF.: 2285.98

EXPLORER 4.6L	89/04
EXPLORER 4.0L	00/UP
RANGER 4.0L, 4 CIL	97/01
EXPLORER SPORT TRACK 4.0L, 6 CIL	06/10
MUSTANG V-6 12V 4L, 8 CIL	06/10
EXPLORER 5.0L, 8 CIL	07/10
EXPLORER MONTAINER 5.0L, 8 CIL	07/10
MUSTANG 5.0L, 8 CIL	05/10
EXPLORER SPORT TU 5.0L, 8 CIL	01/03
RANGER 3.0L, 6 CIL	03/07

AMERICANA

FORD EXPLORER 4.0L, 6 CIL	97/01
EXPLORER	01/05
EXPLORER SPORT	01/03
RANGER 4.0L y 3.0L 6, CIL	98/04
MERCURY MOUNTAINEER 4.0L, 6 CIL	

No. Original: 2L2Z-8575-AA

**APLICA PARA: 7290/KIT, 7293/KIT,
7313/KIT, 7310/KIT, 7312/KIT, 7313/
KIT Y HOUSING 7294, 7295,7311**



S-648

SENSOR (DE ROSCA)

Ref.: 648

EXPLORER 4.6L	89/04
---------------	-------

AMERICANA

EXPLORER 4.0L, 6 CIL	97/01
MERCURY MOUNTAINEER 4.0L, 6CIL	98/01
RANGER 4.0L, 4 CIL	02/UP

No. Original: F8CZ-12A648-B

APLICA PARA: 7290/KIT



S-884

SENSOR (DE ROSCA)

Ref.: 884

EXPLORER 4.6L	89/04
---------------	-------

AMERICANA

EXPLORER 4.0L, 6 CIL	97/01
MERCURY MOUNTAINEER 4.0L, 6 CIL	98/01
RANGER 4.0L, 4 CIL	02/UP

No. Original: F7DZ-10884-AA

APLICA PARA: 7290/KIT



TOMAS DE AGUA

GENERAL MOTORS: CHEVROLET-PONTIAC-BUICK-GMC

TOMAS DE AGUA

GENERAL MOTORS

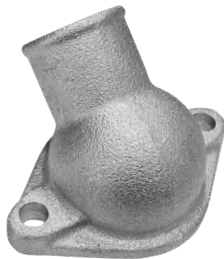

6013

No. Original: 3837223, 539366, 3705018, 3827370

AMERICANA

ALL CHEVROLET 265, 283, 327, 348	55/65
FUEL INJECTION, DUAL 4 BBL. CARB., & SPECIAL HI PERFORMANCE CHECKER	56/62
ALL PONTIAC	65/67
C-K 10/30 PICK-UP, G VAN, P 10/30 STEP & VALUE, SUBURBAN, BLAZER	61/63
	66/67
ALL C-K 10/30 PICK-UP, G 10/30 VAN, P 10/30 STEP VAN & VALUE VAN, SUBURBAN, BLAZER, EXCEPT A.I.R.	55/65
C-K 15/35 PICK-UP, G 15/35 VAN, P 25/35 STEP VAN & VALUE VAN, SUBURBAN, JIMMY CHEVY y GMC	66/67
	55/68



6034

AMERICANA

ALL BUICK 400,401, 425 8 CIL ELECTRA, RIVIERA, WILDCART 8 CIL	64/66
	62/65

No. Original: 1350825



6037

No. Original: 3789162, 5743083 Ref.: 3083

NACIONAL

GM 6 CIL 230, 250, 292

BUICK TODOS 250 VONA, CHEVY II 327	68/73
GMC TODOS C-K 15/35 PICK-UP SUBURBAN, JIMMY, G 15/35 VAN, P 25/35 VAN 6 CIL	64/65
ALL CHEVROLET C-K 10/30 PICKUP, SUBURBAN, BLAZER, G 10/30 VAN, P 10/30 VAN & VALUE VAN	67/73
CHEVY	63/73
GMC	65/73
OLDS	66/71
PONTIAC	64/65



6039

AMERICANA

ALL CHEVROLET 6 CIL VEGA 122 4 CIL	63/66
	75/76
ALL, EXCEPT MONZA & VEGA 140 4 CIL	68/71
ALL CHECKER 230 6 CIL CHEVY	65/67
	64/76

No. Original: 3841191



6040

AMERICANA

ALL CHEVROLET P 10/30 8 CIL, G 10/30	73/76
CHEVROLET C-K 10/30 PICK-UP, SUBURBAN & BLAZER 6 CIL VAN 292, 59/62	63/64
CHEVY y GMC	65/78

No. Original: 3836209, 329223



6057

AMERICANA

PONTIAC TODOS EXCEPT 65 TEMPEST V-8	73/76
PONTIAC	65/70
	64/70

No. Original: 9779072, 9779073



6071

AMERICANA

CHEVROLET CORVETTE HI-PERFORMANCE CAMARO 302; 327, 427	65/68
CORVETTE EXCEPT FI; W/4 BBL. CARB 8 CIL	67/68
CHEVY	62/65
	55/61
	63/68

No. Original: 3827369, 3795013



GENERAL MOTORS: CHEVROLET-PONTIAC-BUICK-GMC

TOMAS DE AGUA



6082

AMERICANA

CADILLAC 500 8 CIL	76
ALL CADILLAC, EXCEPT SEVILLE 8 CIL	68/75

No. Original: 1486784



6092

AMERICANA

BUICK REGAL 250;	82/95
ALL CADILLAC SEVILLE 350	76/79
CADILLAC, FLEETWOOD RWD	86/90
OLDSMOBILE CUTLASS SUPREME 260	82/84
ALL CHEVROLET 307 y 350N DIESEL	80/90
EL CAMINO, MALIBU, MONTECARLO	82/84
ALL OLDSMOBILE EXCEPT 75 y 76 OMEGA	
VENTURA	75
ALL PONTIAC DIESEL;	82/90
C-K PICK UP, SUBURBAN BLAZER DIESEL;	78/81
BUICK y CADILLAC	76/90
CHEVY	78/90
GMC	78/84
OLDS	66/90
PONTIAC	75/89

No. Original: 409037, 547082



6098

AMERICANA

AMC 4 CIL	80/85
CHEVROLET ASTRO VAN, S10 PICK UP & BLAZER 2.5L, 6 CIL	
ALL BUICK V6 400	
ALL CADILLAC V 8	87/92
AMC	80/83
CHEVY	78/90
GMC	78/84
OLDS	66/90
PONTIAC	75/89

No. Original: 478144, 489869, 9782138, 10021153, 10008866, 8132276, 8132282



6099

AMERICANA

BUICK 260, 350R, 403, 455	75/80
CADILLAC, FLEETWOOD RWD	76/90
307 5.0L y 350 5.7L	
EL CAMINO, MALIBU,	82/84
MONTE CARLO 173 2.8L, V-6 260 4.3L	
ALL CHEVROLET C-K 10-30	78
PICKUP, SUBURBAN, BLAZER,	
G 10-30 VAN, P 10-30 STEP VAN & VALUE VAN, EXCEPT 250	
W/INTEGRAL HEAD	
BUICK	68/75
CHEVY	64/79
GMC	65/78
OLDS	68/76
PONTIAC	70/76

No. Original: 338117



6103

AMERICANA

BUICK TODOS CHEVY 305, 350	78/79
CHEVROLET P 10/30 VAN, GMC	
TODOS P 25/35 VAN 8 CIL	
ALL CHEVROLET C-K 10/30 PICKUP,	
SUBURBAN & BLAZER V8 EXCEPT	
DIESEL	
JIMMY	73/77
BUICK	77/79
CHEVY	65/81
GMC	67/81
OLDS	77/78
PONTIAC	71/78

No. Original: 336790, 336773



6122

AMERICANA

CHEVROLET P 10/30 VAN 8 CIL	81/82
EXCEPT 6.2L DIESEL	
V-8 G 10/30 VAN 8 CIL, P10/30,	77/78
CALIFORNIA 350, 454 7.4L	
CHEVY y GMC	73/86

No. Original: 14007353, 346219, 354415, 14088522



TOMAS DE AGUA

GENERAL MOTORS: CHEVROLET-PONTIAC-BUICK-GMC

TOMAS DE AGUA



6132

AMERICANA

CHEVROLET 200 8 CIL MAQ 350	78/79
BUICK	77/81
CHEVY	74/93
GMC	76/91
OLDS	78/83
PONTIAC	77/92

No. Original: 469518



6133

AMERICANA

CHEVROLET C-K 10/30 PICK-UP	78
SUBURBAN, BLAZER, G 10/30 VAN	
250	
CADILLAC TODOS	78/79
EXCEPTO SEVILLE	
CADILLAC TODOS 4.1, 7.0 L	80/85

No. Original: 1609644, 465999



6137

AMERICANA

BUICK TODOS (H, J, X) 8 CIL	77/79
BUICK (A, G, 3) V-6 3.2, 3.8, 5.7 y 7.5L	
ALL BUICK 231 V6	75/76
ALL CHEVROLET A,G,3 196 y 231	78/79
BUICK	65/79
CHEVY	78/80
GMC	78/79
JEEP	66/71
OLDS	75/79
PONTIAC	76/79

No. Original: 12470974, 1254774



6155

AMERICANA

CHEVROLET CHEVETTE 1.6L, 4 CIL	79/81
--------------------------------	-------

No. Original: 14001154



6157

AMERICANA

BUICK SKYLARK, APALLO	80/86
SPECIAL 173 2.8L, V-6	
CENTURY CELEBRITY,	
OLDSMOBILE	
CIERA, PONTIAC 6000 260	
4.3L (T) DIESEL	
CHEVY	80/85

No. Original: 22512846



6158

AMERICANA

CHEVROLET C-K 10/30	78/84
PICK-UP SUBURBAN, BLAZER,	
G 10/30 VAN, NOVA,	
EXCEPT CALIFORNIA 250	
CHEVY	77/84
GMC	79/84

No. Original: 14001969



6156

AMERICANA

BUICK CENTURY, CHEVROLET	80/90
CELEBRITY, OLDSMOBILE CIERA	
& PONTIAC 2.5L, 4 CIL	

No. Original: 10005894, 10019470



6161

NACIONAL

GM V-8, AUTOS, CAMIONES Y CAMIONETAS CON MAQ. 350 79/80

AMERICANA

CHEVROLET TODOS C-K 10/30 PICK-UP SUBURBAN, BLAZER 8 CIL EXCEPTO 6.2L DIESEL V-8 80/84
CORVETTE 8 CIL 79/81
267,305, 350 5.7, 6.6 y 7.4L (G,L)
BUICK 77/81
CHEVY 74/93
GMC 76/91
OLDS 78/83
PONTIAC 77/92

No. Original: 469519, 469518
14088753
Ref.: 8519-A



6163

AMERICANA

BUICK TODOS 350 V-8 80/84
ELECTRA, LESABRE, REGAL
231A V-6, CANADA, MALIBÚ,
CAPRICE, OLDSMOBILE, PONTIAC
231 3.8 y 5.7L
WILDCAT ENGINE - CANADA;
RIVIERA (3.8L) W/4 BBL. CARB;
BELAIR, BISCAYNE, CAPRICE,
IMPALA, BROOKWOOD,
KINGSWOOD;
ALL CHEVROLET (A) ENGINE,
CAFORNIA; EL CAMINO, MALIBU,
MONTE CARLO & 2 BBL.

No. Original: 25502660, 25513298



6165

AMERICANA

CADILLAC TODOS 368 V-8 5.0L EFI 80/84
CHEVROLET TODOS
PONTIAC V-6 229 3.8L

No. Original: 1616501



6182

AMERICANA

CHEVROLET TODOS C/BULBO 81/84
PONTIAC V-6 229

No. Original: 14024297



6162

NACIONAL

CUTLASS, CENTURY C/BULBO 85/86
MOTO VENTILADOR 5/8
SKYLARK (W), CIMARRON(W)
FI, CAVALIER 173 2.8L, CHEVETTE 1.6L

AMERICANA

CHEVETTE 1.6L; SKYLARK (W) 2.8L 85
CIMARRON (W)/FUEL INJECTION, 85/86
CAVALIER (2.8L) (W); CELEBRITY (2.8L) (W)
CITATION (2.8L) (W) ; CIERA (W)
FIRENZA (W) 6000 (2.8L) (W) H.O.
CADILLAC 85/86
CHEVY 79/87
OLDS 85/86
PONTIAC 81/87

No. Original: 14001120



6164

AMERICANA

FLEETWOOD, DE VILLE 4.1 80/81
ALL CADILLAC (4.1L) V6, W/EFI 82
ALL CADILLAC (4.1L) 80/84
ALL CHEVROLET (A) & FED.
EMISIONS AIR, 84/85
EXCEPT CALIFORNIA 6 82
BISCAYNE, EXCEPT CALIFORNIA 82
CAPRICE (A)
ENGINE W/CLOSED LOOP V6
OLDSMOBILE 98 (3) 85
REGENCY (3)
BUICK 80/81
CADILLAC 82
CHEVY 81
PONTIAC 81/82

No. Original: 25502661, 25509087



6185

AMERICANA

CHEVROLET CAMARO, PONTIAC 80/82
FIREBIRD 5.0L, V-8 EFI,
CHEVROLET PONTIAC TODOS
V-6 229

No. Original: 14014426, 14037618



TOMAS DE AGUA

GENERAL MOTORS: CHEVROLET-PONTIAC-BUICK-GMC

TOMAS DE AGUA



6186

AMERICANA

BUICK SKYLARK, CAVALIER OLDSMOBILE FIEREZA, PONTIAC J2000, EXCEPT OHC, CADILLAC	82/86
No. Original: 14018750	



6190

AMERICANA

CAMARO (2.8L), PONTIAC FIREBIRD, CHEROKEE, COMMACHE, WAGONEER, S10 PICK-UP, BLAZER S15 PICK-UP, JIMMY CHEVY Y GMC	82/85 86 82/84
--	----------------------

No. Original: 14033082



6191

NACIONAL Y AMERICANA

CENTURY, CELEBRITY, SKYLARK APOLLO 173 (2.8L) (X,Z), V6	82/86
OLDSMOBILE CIERA, PONTIAC 6000, PHOENIX EXP HO y OMEGA 173 2.8L	82/87
BUICK, CHEVY, OLDS PONTIAC	82/86 80/86

No. Original:
14092928, 14033198

Ref.: 628



6199

AMERICANA

BLAZER, JIMMY, SUBURBAN CREW CAB, CAB OLDSMOBILE CUTLASS, CALIFORNIA 5.0 y 5.7L CAMARO 8 C CORVETTE 8 C ALL PONTIAC EXCEPT 82 FIREBIRD W/5.0L W/FUEL INJECTION	89/90 '83 85/89 82,84 82/84
BUICK CHEVY GMC OLDS y PONTIAC	82/85 81/90 82/86 82/87

No. Original: 1403376, 14087075



6209

AMERICANA

CHEVROLET P 10/30 STEP VAN & VALUE VAN GMC 25/35 CHEVROLET C-K 10/30 PICKUP, SUBURBAN & BLAZER GMC C-K 15/35 & JIMMY V8, 6.2L / DIESEL CHEVY y GMC	1982
---	------

No. Original: 14028918



6210

AMERICANA

OLDSMOBILE CIERA REGENCY V-6 181 3.0L	98
CENTURY, ELECTRA V-6 183 3.0L BUICK Y OLDS	82/85 82/85

No. Original: 25500204



TOMAS DE AGUA



6230

AMERICANA

MONTE CARLO, EL CAMINO 231	85/87
CUTLASS, PONTIAC TODOS 231 6 CIL	
BUICK	82/88
CHEVY	84
GMC	84/87
OLDS	80/87
PONTIAC	82/87

No. Original: 25517009, 25523589



6233

NACIONAL

S10 2.2L, 4 CIL	95/03
-----------------	-------

AMERICANA

BUICK SKYHAWK, CAVALIER y BERETTA 2.2L, 4 CIL	93/96
OLDSMOBILE 2.0L	87/96
CORSICA 2.2L, 4 CIL	
CENTURY 2.2L, 4 CIL	93/96
VEHICLE 2.2L, 4 CIL	94/95
CUTLASS CIERA 2.2L, 4 CIL	93/94
SUNFIRE 2.2L, 4 CIL	95/96

No. Original: 14090036, 10103619



6234

AMERICANA

BUICK OLDSMOBILE, PONTIAC, BONEVILLE 3.8L, 6 CIL	TODOS 88
--	-------------

No. Original: 25532950



6236

NACIONAL

GM V6 MOTOR 189 3.1L	88/96
CUTLASS	90/91
CAVALIER	

AMERICANA

BERETTA, CAVALIER 3.1L, 6CIL	90/91
CIMARRON 2.8L HO	87/88
PONTIAC 6000 3.1L (SIN ENTRADA)	87/89

No. Original: 14092251, 10065479
Ref.: 1683

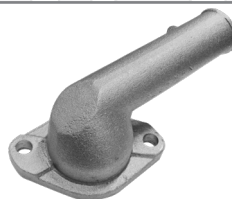

6237

AMERICANA

CHEVROLET CAMARO, PONTIAC FIREBIRD 5.0L EXCEPT TBI 5.7L, 8 CIL	87/92
MONTE CARLO W/5.0L ENGINE, CALIFORNIA	88
CHEVY	85/92
GMC	86
PONTIAC	85/92

No. Original: 14084383



6235

AMERICANA

CADILLAC DEVILLE, FLEETWOD 4.5L V-8	'90
EL DORADO, DEVILLE, SEVILLE, FLEETWOD 4.9L V-8	
CADILLAC	85/95

No. Original: 1625774, 3520936



6238

NACIONAL Y AMERICANA

SUBURBAN, SILVERADO, MICROBUS TBI NACIONAL, BLAZER, JIMMY, CREW CAB, CHASSIS CAB 5.7L, 8 CIL V-8M-350	89/91
CADILLAC	90/92
CHEVY y GMC	88/96

No. Original: 14102149, 10110827



TOMAS DE AGUA

GENERAL MOTORS: CHEVROLET-PONTIAC-BUICK-GMC

TOMAS DE AGUA



6240

AMERICANA

CHEVROLET 4.3L, 6 CIL C10/30 PICK UP, K10/30 G10/30 VAN ASTROVAN 510 PICK UP, BLAZER C15/35 PICK UP K15/35 VAN, SAFARI VAN S15 PICK UP JIMMY. CADILLAC y GMC OLDS	85/99 85/96 91/92
---	---

No. Original: 14081284



6241

AMERICANA

FULL SIZE G SERIES GM VAN V-8 454, 5.0 y 5.7L CHEVY y GMC	83/91 83/91
---	--------------------

No. Original: 14055159



6242

NACIONAL Y AMERICANA

CHEVROLET ST 10 y GMC ST 15 2.8L, V-6 173R CHEVY GMC ISUZU	86/91 86/93 86/93 91/94
--	--------------------------------------

No. Original: 14091876



6243

AMERICANA

BUICK, OLDSMOBILE, PONTIAC, BONNEVILLE 3.8L	88/91
--	-------

No. Original: 25535941



6247

NACIONAL Y AMERICANA

C 1500, 2500, 3500 PICK-UP, SUBURBAN G 10, 20, 30, VAN, K 1500, 2500 3500 PICK-UP P 30 VAN TAHOE	92/95 '95
---	------------------------------

No. Original: 10147884



6246

NACIONAL

GENERAL MOTOR V-6 MOTOR 173 2.8L y 189 3.1L CAVALIER	92/95
--	-------

AMERICANA

CHEVORLET LUMINA APV OLDSMOBILE SILOUTTE, PONTIAC TRANSPORT 3.1L (CON ENTRADA)	90/94
---	-------

No. Original: 10151684 **Ref.: 1683-A**



6245

AMERICANA

BUICK REGAL, CUTLASS SUPREME, PONTIAC GRAND PRIX 2.8 Y 3.1L CHEVROLET LUMINA 3.1L CHEVY OLDS	88/93 90/93 90/94 88/94
--	--------------------------------------

No. Original: 10065502, 14100587



6250

NACIONAL Y AMERICANA

RIVERA ELECTRA, LESABRE, EST WAGON, PARK AVE, OLDS NINE- LY-EIGHT, TORNADO, REGAL, REATTA, LUMINA APV, SILHOUTTE DELTA, CUSTOM, CRUSIER, PONTIAC, TRANSPORT 3.8L 6 CIL	88
BUICK Z	90/94
CHEVY	92
OLDS	91/92
PONTIAC	92

No. Original: 24500500



6255

NACIONAL

CHEVY CORSA 1.4L y 1.6, 4 CIL 94/03

AMERICANA

OPEL, CHEVY, MONZA, CORSA 1.4L y 1.6L 94/03
PONTIAC LEMANS 1.6L, 4 CIL 88/93

No. Original: 90234805
Ref.: 4805



6256

NACIONAL

SUBURBAN, C-K 1500,
2500 V-8 5.7 y 7.4L 86/03
GMC 1500 SIERRA V-6, 4.3L 96/03
S-15 BRAVADA V-6, 4.3L 96/01

AMERICANA

K, C 1500-2500 SUBURBAN
S-10 BLAZER Y PICK-UP,
SILVERADO 1500 LS, WT,
1500 CLASSIC LS, CLASSIC WT,
WT S15 JIMMY, BLAZER,
TRAIL, BLAZER, EXPRESS
1500 SONOMA;
CHEVY, GMC 96/07
ISUZU 97/00
OLDS 96/01

No. Original: 12557563



6251

Ref.: 8519

NACIONAL Y AMERICANA

AUTOS V-8	73/UP
CAMIONES Y CAMIONETAS CON MAQ. 350 (SIN ENTRADAS)	

No. Original: 1414427



6255-T

Ref.: 4805-T

NACIONAL

CHEVY VAGONETA (PICK UP)
1.4/1.6L, 4 CIL 02/UP
CORSA MERIVA Y TORNADO 1.8L, V8 02/08

CON LIGA Y TERMOSTATO

AMERICANA

CHEVY PICKUP 1.6L, 4 CIL 02/UP

No. Original: 93275736



6257

NACIONAL Y AMERICANA

CAVALIER 2.2 4 CIL 95/04

No. Original: 24574528



TOMAS DE AGUA

GENERAL MOTORS: CHEVROLET-PONTIAC-BUICK-GMC

TOMAS DE AGUA

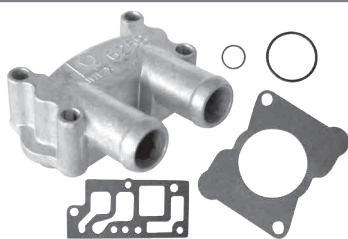

6258

NACIONAL Y AMERICANA

KIT CUERPO DE ACCELERACIÓN

CAVALIER 6CIL

90/94

No. Original: 17111959



6259

NACIONAL Y AMERICANA

CAVALIER y PONTIAC SUNFIRE

2.2L, 4 CIL

98/02

No. Original: 24575474



6260

SIN TERMOSTATO

NACIONAL

PICK-UP 1500, 2500

EXPRESS VAN

TRAIL BLAZER

CAMARO

CORVETTE

00/07

03/08

02/08

97/02

97/04

AMERICANA

CADILLAC ESCALADE V8

CORVETTE

EXPRESS 2500, SILVERADO 1500 V8

SILVERADO 1500 HD, 2500 HD V8 6.0

SILVERADO 3500, SIERRA 3500

SSR V8

TAHOE

TRAILBLAZER

SAVANA 2500, 3500

SIERRA DENALI y YUKONV8 6.0

CAMARO V8 5.7

SUBURBAN 1500 V8 5.3

2500 6.0

FIREBIRD V8 5.7

SIERRA C3 V8 6.0

CHEVY

GMC

HUMMER

03

03/97

03

03/99

01/03

03

00/03

03

03

01/03

98/02

01/02

01/02

98/02

2001

96/05

99/05

03

No. Original: 12571261

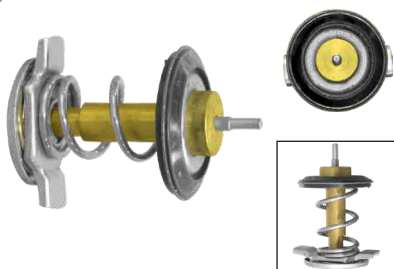

T-6260

TERMOSTATO

PICK-UP 1500, 2500

EXPRESS VAN

TRAIL BLAZER

CAMARO

CORVETTE

00/07

03/08

02/08

97/02

97/04

AMERICANA

CADILLAC ESCALADE V8

CORVETTE

EXPRESS 2500, SILVERADO 1500 V8

SILVERADO 1500 HD, 2500 HD V8 6.0

SILVERADO 3500, SIERRA 3500

SSR V8

TAHOE

TRAILBLAZER

SAVANA 2500, 3500

SIERRA DENALI y YUKONV8 6.0

CAMARO V8 5.7

SUBURBAN 1500 V8 5.3

2500 6.0

FIREBIRD V8 5.7

SIERRA C3 V8 6.0

CHEVY

GMC

HUMMER

03

03/97

03

03/99

01/03

03

00/03

03

03

01/03

98/02

01/02

01/02

98/02

2001

96/05

99/05

03

APLICA PARA TOMA DE AGUA 6260



6261

SIN TERMOSTATO

NACIONAL Y AMERICANA

CAMIONETAS y PICK UP

AVALANCHE, SUBURBAN, ESCALADE,

SONORA, SIERRA, YUKON, 2500 y 3500

MOTORES 5.3L, V8

99/05

99/05

No. Original: 12600172

6261-T

CON

TERMOSTATO



6260-T

CON

TERMOSTATO

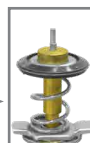

**VENTA INDIVIDUAL DE
TERMOSTATO T-6260**



6262

NACIONAL

MALIBU MOTOR 6 CIL 2.4L	96/02
-------------------------	-------

AMERICANA

MALIBU	96/02
CAVALIER	00/02
ALERO y GRAND AM	00/01
SUNFIRE 2.4L, 4 CIL	00/02
BUICK	96/98
CHEVY Y PONTIAC	96/02
OLDS	96/01

No. Original: 24575259



6263

NACIONAL Y AMERICANA

CAVALIER	95/02
PONTIAC SUNFIRE 4 CIL	94/95
BUICK, OLDS y PONTIAC	94/95
CHEVY	94

No. Original: 24573020



6264

AMERICANA

CAVALIER	97/98
PONTIAC SUNFIRE 2.2L, 4 CIL	96/98
CHEVY	96/97

No. Original: 24575189



6265

NACIONAL

SONOMA, S10 PICK UP L4 2.2L	98/03
S15 PICK UP L4 2.2L	

AMERICANA

S10 PICK-UP Y S15 SONOMA	94/03
2.2L 4 CIL	
CHEVY y GMC	98/03
ISUZU	98/00

No. Original: 24576531

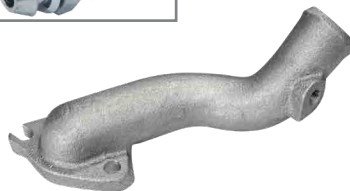

6266

NACIONAL

UPLANDER 3.5L, 6 CIL	05/09
VENTURE 3.4L, 6 CIL	97/05
PONTIAC AZTEK 3.4L, 6 CIL	01/05
IMPALA 3.4L, 6 CIL	00/05

CON PURGADOR(13901X)

No. Original: 10182344

AMERICANA:

BUICK CENTURY 3.1L, V6	03
CENTURY CUSTOM 3.1L	00/05
V6 CENTURY LIMITED 3.L, V6	00/05
CENTURY SPECIAL EDITION 3.1L, V6	05
RENDEZ VOUS 3.4L, 5L, V6	02/05
RENDEZ VOUS CXL 3.5L, V6	06/07
TERRAZA CXV6	05/06
CHEVROLET IMPALA 3.4L, V6	00/05
LUMINA 3.1L, V6	00/01
MONTE CARLO LS 3.4L, V6	00/05
UPLANDER LS, LT 3.5L V6	05/06
VENTURE 3.4L V6	00/04
VENTURE LS, LT, PLUS 3.4L, V6	05
OLDSMOBILE SILHOUETTE 3.4L, V6	00/04
PONTIAC AZTEK 3.4L, V6	01/05
AZTEK GT 3.4L, V6	01
AZTEK RALLY 3.4L, V6	04
GRAND PRIX-3.1L, V6	00/03
MONTANA 3.4L, V6	00/05
MONTANA SV6 3.5L, V6	05/06
SATURN RELAY 2.0, 3.0, 3.5L, V6	05/06



TOMAS DE AGUA

GENERAL MOTORS: CHEVROLET-PONTIAC-BUICK-GMC

TOMAS DE AGUA



6267

NACIONAL: BLAZER S10 6C 4.3L, 6 CIL	95/99
AMERICANA: CHEVROLET ASTRO V6 4.3L C1500-2500 PICK UP V6 4.3L G10/20/30 VAN V6 4.3L, K1500-2500 PICK UP V6 4.3L P30 VAN V6 4.3L S10 BLAZER y PICK UP V6 4.3L GMC C1500-2500 PICK UP V6 4.3L G15/G1500, G25/G2500, G35/ G3500 VAN V6 4.3L K1500-2500 PICK UP V6 4.3L P3500 VAN V6 4.3L S15 JIMMY V6 4.3L S15 SONORA V6 4.3L SAFARI V6 4.3L OLDSMOBILE BRAVADA V6 4.3L	90/94 92/95 92/95 92/95 91/95 91/95 92/95 92/95 92/95 91/95 91/94 91/95 90/94 91/92
No. Original: 10172831	



6268

NACIONAL EXPRESS VAN 4.3L, 6 CIL BLAZER 4.3L, 6 CIL HEAVY DUTTY 4.3L, 6 CIL	03/08 95/99 97/04
AMERICANA CHEVROLET ASTRO V6, 4.3L C1500 PICK-UP V6, 4.3L EXPRESS1500-2500 V6, 4.3L G10 VAN V6 4.3L G20 VAN V6 4.3L K1500 PICK-UP V6 4.3L P30 VAN V6 y V8 4.3 y 5.7L GMC C1500 PICK-UP 97-98 V6, 4.3L G15/G1500, G25/G2500 VAN V6, 4.3L K1500 PICK-UP V6, 4.3L P35/P3500 VAN V6 y V8 4.3 y 5.7L P3500 VAN V6 y V8 4.3 y 5.7L SAFARI V-6 4.3L SAVANA 1500-2500 V-6, 4.3L	96/05 97/98 00/06 96/98 1996 97/98 97/98 96/98 97/98 96/98 1999 96/98 96/05 99/06
No. Original: 12556593	



6269

NACIONAL EXPRESS VAN 4.3L, 6 CIL PICK UP 5.7L, 8 CIL HEAVY DUTTY 8CIL	97/02 99/02
AMERICANA CADILLAC ESCALADE V8, 5.7L CHEVROLET C1500-2500 PICK-UP V8, 5.7L SUBURBAN V8, 5.0 y 5.7L C3500 PICK-UP V8, 5.7L EXPRESS 1500-2500-3500 V8, 5.0 y 5.7L G10-20-30 VAN V8, 5.0 y 5.7L K1500-2500 PICK-UP V8, 5.7L SUBURBAN V8, 5.0 y 5.7L K3500 PICK-UP V8, 5.7L TAHOE V8, 5.7L GMC C1500-2500-3500 PICK-UP V8, 5.0 y 5.7L G25/G2500, G35/G3500 VAN V8, 5.7L K1500-2500 PICK-UP V8, 5.7L SUBURBAN V8, 5.0 y 5.7L K3500 PICK-UP V8, 5.7L SAVANA 1500-2500-3500 V8, 5.0 y 5.7L YUKON V8, 5.7L	99/00 00 96/00 96/00 99/02 96/98 00 96/98 96/00 96/00 99/02 96/00 96/00 99/02 96/00
No. Original: 12556594	



6270

SIN TERMOSTATO	
NACIONAL TRAILBLAZER L6 4.2L CANYON L4 2.8L	02/07 04/06
AMERICANA ISUZU ASCENER, BUICK RAINIER Y OLDSMOBILE; BRAVADA; ENVOY SLE, SLTXL, XUV; TRAIL- BLAZER LT, LS, EXT 4.2L, 6 CIL	
No. Original: 24576963	



6271

SIN TERMOSTATO	
NACIONAL CADILLAC CATERA V6, 3.0L SAAB 9-5, 900 SE V6, 3.0L SATURN L SERIES V6, 3.0L	97/01 99/01 02/04
AMERICANA CADILLAC CTS V6 3.2, SAAB 900 Y 9000 V6 2.5	01/05 94/97
No. Original: 9129999	



**6270-T
CON TERMOSTATO**

VENTA INDIVIDUAL DE TERMOSTATO T-6270

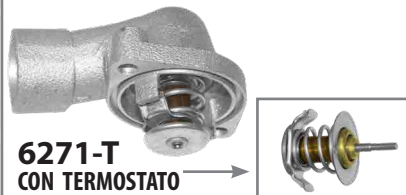

**6271-T
CON TERMOSTATO**

VENTA INDIVIDUAL DE TERMOSTATO T-6271

TOMAS DE AGUA

GENERAL MOTORS: CHEVROLET-PONTIAC-GMC



TOMAS DE AGUA



6272

SIN TERMOSTATO

NACIONAL Y AMERICANA

SATURN SC, SL y SW L4 1.9L

91/02

No. Original: 21006065

**6272-T
CON
TERMOSTATO**

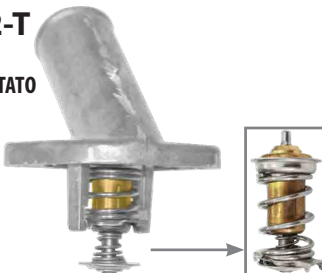

VENTA INDIVIDUAL DE TERMOSTATO T-6272



6273

AMERICANA

CHEVROLET BEL AIR
BISCAYNE
CAMARO
CAPRICE
CAPRICE CLASSIC y ESTATE
CHEVELLE
DELUXE
CONCOURS
GREENBRIED
MALIBU Y NOMAD
CHEVY II
EL CAMINO y CORVETTE
CAMINO CUSTOM
IMPAPLA
KINGSWOOD
MALIBU, NOVA
MALIBU ESTATE
SPRINT
SPRINT CUSTOM
CHEVY
GMC

66/73
66/72
67/73
66/72
73
66/72
68/69
68/72
69/72
68/72
66/67
66/73
68/73
66/73
69/72
66/73
73
71/73
72/73
66/73
71/73

No. Original: 3877660, 3896958



T-6270

TERMOSTATO

NACIONAL

TRAILBLAZER L6 4.2L GMC
CANYON L4 2.8L

02/07
04/06

AMERICANA

ISUZU ASCENER, BUICK RAINIER y
OLDSMOBILE;
BRAVADA;
ENVOY SLE, SLTXL, XUV;
TRAIL- BLAZER LT, LS, EXT 4.2L, 6 CIL

APLICA PARA TOMA DE AGUA 6270

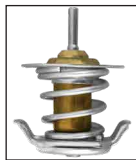
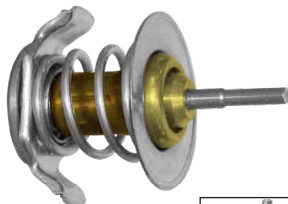

T-6271

TERMOSTATO

NACIONAL

CADILLAC CATERA V6, 3.0L
SAAB 9-5, 900 SE V6, 3.0L,
SATURN L SERIES V6, 3.0L

97/01
99/01
02/04

AMERICANA

CADILLAC CTS V6, 3.2L
SAAB 900 y 9000 V6, 2.5L

01/05
94/97
y 96/97

APLICA PARA TOMA DE AGUA 6271



T-6272

TERMOSTATO

NACIONAL Y AMERICANA

SATURN SC, SL y SW L4 1.9L

91/02

APLICA PARA TOMA DE AGUA 6272

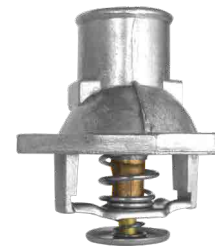

6274

CON TERMOSTATO

NACIONAL

VECTRA 2.0 y 2.2L, 4 CIL, 8V

94/04

No. Original: 90410665



TOMAS DE AGUA

GENERAL MOTORS: CHEVROLET-PONTIAC-BUICK-GMC

TOMAS DE AGUA



6275

CON TERMOSTATO

NACIONAL Y AMERICANA

ASTRA GLS BRASIL 1.8L y 2.0L, 4 CIL, V8 04/06

No. Original: 90352677



6276

**NACIONAL Y AMERICANA
CON TERMOSTATO**

ASTRA, VECTRA y ZAFIRA 2.2L y 2.4L, 4 CIL, 16V (BRASIL) 96/UP
OPTRA TODOS LOS MOTORES 2.0L 07/10
COLORADO 2.5L, 4CIL 12/15

No. Original: 90501699



6277

**NACIONAL Y AMERICANA
CON SENSOR Y TERMOSTATO**

ASTRA, ZAFIRA y VECTRA 1.8L, 4 CIL 01/07
ASTRA, ZAFIRA y VECTRA 2.0L, 4 CIL 04/06

No. Original: 24456401



6278

**NACIONAL
CON SENSOR**

AVEO 1.6L, 4 CIL 04/07

AMERICANA

AVEO LS 04/07
AVEO LT SPECIAL VALUE 05/07
LANOS 1.6L, 4 CIL 00/02

No. Original: 96282726



6279

NACIONAL

C2500-3500, K2500-3500 PICK UP V8 7.4L, SUBURBAN C2500/ K2500, VAN P30/P35/P3500 V8 7.4L 96/99
PICK UP SIERRA/XC C2500/K3500, K2500/3500 V8 7.4L 96/98

AMERICANA

C/K 2500 PICK UP,
C/K 3500 PICK UP, EXPRESS 3500,
C/K 2500 PICK UP, C/K 3500 PICK UP,
SAVANA 3500 7.4L, 8 CIL

No. Original: 10226490



6280

**NACIONAL Y AMERICANA
SIN TERMOSTATO**

COLORADO L4 2.8L y L5 3.5L 04/05
COLORADO LS 3.7L 07/08
CANYON L4 2.9L y L5 3.5L 07/09
CANYON L4 2.8L 04/06
y L5 3.7, 07/08
HUMMER H3 L5 3.7L 07/09
2006



**6280-T
CON TERMOSTATO**

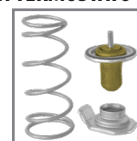

VENTA INDIVIDUAL DE TERMOSTATO T-6280

TOMAS DE AGUA

GENERAL MOTORS: CHEVROLET-PONTIAC-BUICK-GMC



TOMAS DE AGUA

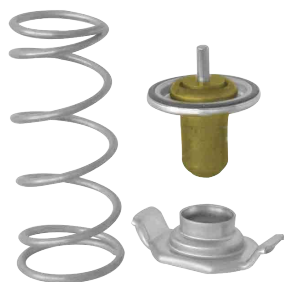

T-6280

TERMOSTATO

NACIONAL Y AMERICANA

COLORADO L4 2.8L, y L5 3.5L	04/05
COLORADO LS 3.7L	07/08
CANYON L4 2.9L y L5 3.5L	07/09
CANYON L4 2.8L	04/06
Y L5 3.7	07/08
HUMMER H3 L5 3.7L y 3.5L	07/09
	2006

APLICA PARA TOMA DE AGUA 6280



6281

NACIONAL

MATIZ 1.0L, 4 CIL 04/06

No. Original: 96317980

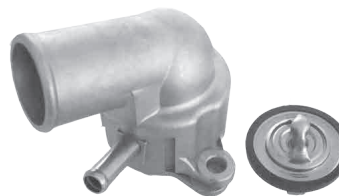

6282

NACIONAL CON TERMOSTATO

AVEO 1.6L, 4 CIL 08/UP

No. Original: 96407677



6283

NACIONAL

CAPTIVA 2.4L, 4 CIL 08/11

No. Original: 12607291



6284

NACIONAL

CAPTIVA 3.2L, 6 CIL 2007

No. Original: 92067797



6285

NACIONAL

CAPTIVA 3.6L, 6 CIL 08/10

No. Original: 12607195



6286

NACIONAL

CAPTIVA 3.0L, 6 CIL 2011

No. Original: 12622596



6287

NACIONAL CON TERMOSTATO

OPTRA 1.4L, 4CIL 02/07

No. Original: 96460002

Compañía Industrial Quezada S. A. de C. V.

San Esteban No. 47-1 Col. San Sebastián, C.P. 02040, Azcapotzalco - Ciudad de México

Tels. (01-55) 5353-0690, 5353-0816, 5353-0774 / www.quezada.com.mx / E-mail: ventas@quezada.com.mx



TOMAS DE AGUA

GENERAL MOTORS: CHEVROLET-PONTIAC-BUICK-GMC

TOMAS DE AGUA



6288

**NACIONAL
CON TERMOSTATO**

OPTRA 1.6L, 4 CIL

08/11

No. Original: 96835286



6289/KIT

REF.: 6289-KIT
(TOMA DE AGUA, HOUSING, TERMOSTATO Y SENSOR)

NACIONAL

OPTRA 1.8L, 4 CIL

07/11

No. Original: 96414627



6290

NACIONAL

ACADIA 3.6L, 6 CIL

07/11

No. Original: 12591005



6291

**NACIONAL
CON TERMOSTATO Y SENSOR DE TEMPERATURA**

SPARK 1.0L, 4 CIL
MATIZ 1.0L, 4 CIL

2011
08/11

No. Original: 96988257



6293

NACIONAL

LUMINA 3.4L, 6 CIL
GRAND PRIX 5.0L, 8 CIL
MONTE CARLO 5.0L, 8 CIL

95/99
88/91
95/99

AMERICANA

CHEVROLET LUMINA
MONTE CARLO
OLDSMOBILE CUTLASS SUPREME
PONTIAC GRAND PRIX 3.4L, 6 CIL

91/95
'95
91/95
91/95

No. Original: 10162146



6294

NACIONAL

CON SENSOR Y TERMOSTATO

MERIVA 4 CIL. 1.8L
ZAFIRA 4 CIL. 1.8L
ASTRA 4 CIL. 1.8L

07/08
06/08
07/08

No. Original: 55577072

APLICA PARA HOUSING 6296



6292

NACIONAL

CAMARO 3.4L, 6 CIL

93/02

No. Original: 10151656

TOMAS DE AGUA

GENERAL MOTORS: CHEVROLET



TOMAS DE AGUA



6294-KIT

(TOMA DE AGUA 6294, HOUSING 6296, SENSOR Y TERMOSTATO)

NACIONAL

MERIVA 1.8L, 4 CIL	07/08
ZAFIRA 1.8L, 4 CIL	06/08
ASTRA 1.8L, 4 CIL	07/08

No. Original: 55577072, 96984103, 55579951, 25199824



6295

NACIONAL

CON SENSOR Y TERMOSTATO

CRUZE 1.8L, 4 CIL	10/18
TRAX 1.8L, 4 CIL	13/18
SONIC 1.6L, 4 CIL	12/18
MERIVA 1.8L, 4 CIL	07/08
AVEO 1.6L, 4 CIL	09/10
PONTIAC G3 1.6L, 4 CIL	09/10
ZAFIRA 1.8L, 4 CIL	06/08
ASTRA 1.8L, 4 CIL	07/08

No. Original: 55578419, 25199828

APLICA PARA HOUSING 6296



6295-KIT

NACIONAL

(TOMA DE AGUA 6295, HOUSING 6296, SENSOR Y TERMOSTATO)

CRUZE 1.8L, 4 CIL	10/18
TRAX 1.8L, 4 CIL	13/18
SONIC 1.6L, 4 CIL	12/18
MERIVA 1.8L, 4 CIL	07/08
AVEO 1.6L, 4 CIL	09/10
PONTIAC G3 1.6L, 4 CIL	09/10
ZAFIRA 1.8L, 4 CIL	06/08
ASTRA 1.8L, 4 CIL	07/08

No. Original: 55578419, 25199828, 96984103, 55579951, 25199824



6296

NACIONAL

ASTRA, ZAFIRA y MERIVA 1.8L, 4 CIL	06/09
CRUZE 1.8L, 4 CIL	10/14
AVEO 1.6L, 4 CIL	09/13
SONIC 1.6L, 4 CIL	12/14
TRAX 1.8L	12/14

No. Original: 96984103, 55579951, 25199824

APLICA PARA T/A 6294 y 6295



6297

NACIONAL Y AMERICANA
CON TERMOSTATO

EQUINOX 3.6L, 6 CIL	08/09
SATURN	06/13

No. Original: 12651113



6298

NACIONAL

TRACKER 1.6L, 4 CIL	99/02
---------------------	-------

No. Original: 19193930, 91174499, 91177754, 91177759



TOMAS DE AGUA

GENERAL MOTORS

TOMAS DE AGUA



6299

**NACIONAL
CON TERMOSTATO**

OPTRA L4 2.0L, 4 CIL 03/14

No. Original: 92062728



6300

MATIZ (G2) L4, 1.0L 04/14

No. Original: 96666227



NUEVO

6301

CORVETTE	2014
SILVERADO	15/18
SIERRA	15/18
CHEYENNE 03, 43, 53 BODYSTYLE (2WD)	15/18
TAHOE	15/18
YUKON	15/18
ESCALADE 06 BODYSTYLE (4WD/AWD)	15/18
SUBURBAN	15/18
ESCALADE 06 BODYSTYLE (2WD) 6.2L, 8 CIL	15/18

No. Original: 12674639



6302

CRUZE, ENCORE 1.4L, 4 CIL	16/19
TRAX 1.4L, 4 CIL	19
SONIC RS 1.4L, 4 CIL	14/16

No. Original: 55565336
55593034



NUEVO

6304

SILVERADO	15/16
SIERRA	15/16
CHEYENNE 03, 43, 53 BODYSTYLE (2WD)	15/16
TAHOE	15/16
YUKON	15/16
ESCALADE 06 BODYSTYLE (2WD)	15/16
SUBURBAN	15/16
YUKON XL	15/16
ESCALADE ESV-06 BODYSTYLE (4WD/AWD) 6.6L 8 CIL	15/16

No. Original: 12674639



NUEVO

6305

SPARK 1.4L, 4 CIL 14/19

No. Original: 12656949

TOMAS DE AGUA

GENERAL MOTORS/HONDA



TOMAS DE AGUA



6307

CRUZE 1.4L TURBO 4 Cil	14/17
TRAX, ENCORE 1.4L, 4 Cil	13/20
SONIC RS 1.4L TURBO 4 Cil	14/16
No. Original: 25193922	

HONDA

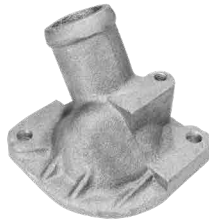

9251

AMERICANA

HONDA CIVIC CVCC 1.5, WAGON,	84/88
CRX C/A.T. EXCEPT . HI ALT	
CIVIC HATCHBACK, CRX C/1332	84/87
CC, 4 CIL	
No. Original: 19311-PE2-000	
19311-PE0-000	



9253

NACIONAL

PRELUDE, ACCORD	83/90
1.8 y 2.0L, 4 CIL	
No. Original: 19311-PC6-000	



9257

AMERICANA

ACCORD, CIVIC CVCC 1.3 ,1.5 y	76/84
1.8L, 4 CIL	
ACCORD Y PRELUDE 1.5L y 1.8L, 4 CIL	
No. Original: 19311-PA6-000,	
19311-PA0-000, 19311-657-020	



9258

**NACIONAL
SIN TERMOSTATO**

CIVIC SL L4 2.0L	03/07
CR-V L4 2.4L	03/07
ACURA RSX L4 2.0L	02/06

AMERICANA

RDX 2.3L	07/09
TSX 2.4L	04/09
CSX TYPE-S 2.0L	07/08
CIVIC MUGEN SI 2.0L	02/08
CR-V EX, EXL, LX 2.4	06
CSX PREMIUM, TOURING	02/06
RSX TYPE-S 2.0L, 4 CIL	

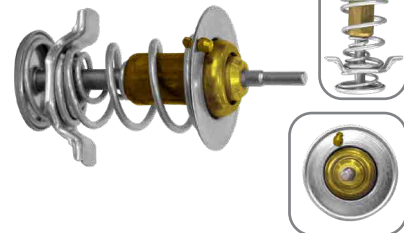

T-9258

TERMOSTATO

NACIONAL

CIVIC SL L4 2.0L	03/07
CR-V L4 2.4L	03/07
ACURA RSX L4 2.0L	02/06

AMERICANA

RDX 2.3L	07/09
TSX 2.4L	04/09
CSX TYPE-S 2.0L	07/08
CIVIC MUGEN SI 2.0L	02/08
CR-V EX, EXL, LX 2.4; CSX PREMIUM,	06
TOURING	
RSX TYPE-S 2.0L, 4 CIL	02/06



9261

NACIONAL Y AMERICANA

ACCORD 4 CIL	96/01
CITY Y FIT 1.5L, 4 CIL	09/12
CIVIC 1.8L, 4 CIL	97/03
No. Original: 19311-P08-000	

**9258-T
CON
TERMOSTATO**





TOMAS DE AGUA

HONDA/ HYUNDAI

TOMAS DE AGUA



9259

**NACIONAL Y AMERICANA
CON TERMOSTATO**

ACCORD Y ELEMENT L4 2.4L, 4 CIL	03/09
ACURA TSX L4 2.4L	01/09



9262

**NACIONAL Y AMERICANA
CON TERMOSTATO**

CIVIC SI, CRV 2.0L, 4 CIL	07
No. Original: 19301-RAF-003, 19301-RAF-004	



NUEVO

9263

ACCORD 3.0L V6	03/04
No. Original: 19311-RCA-A00	



NUEVO

9264

ACCORD EX 3.0L V6	05/07
No. Original: 19311-RJA-A00	



NUEVO

9265

CIVIC 1.8L 4 CIL	06/11
No. Original: 19311-RNA-A00	

HYUNDAI



9501

NACIONAL

ATOS 1.0L, 4 CIL	01/04
------------------	-------

BULBO

AMERICANA

ACCENT BULB 1.5L, 1.6L, 4 CIL	01/03
-------------------------------	-------

No. Original: 25611 02502

APLICA PARA TOMA DE AGUA 9502



9502

NACIONAL

ATOS 1.0L, 4 CIL	01/04
------------------	-------

TERMOSTATO

AMERICANA

ACCENT 1.5L, 1.6L, 4 CIL	95/02
--------------------------	-------

No. Original: 25632-02501

**APLICA PARA TOMA DE AGUA 9501
Y 9503**



9503

NACIONAL
ATOS 1.0L, 4 CIL
(MODULO HOUSING)

01/04

AMERICANA

ACCENT HOUSING 1.5L,
1.6L, 4 CIL

01/03

No. Original: 25622-02501

APLICA PARA TOMA DE AGUA 9502



9504

NACIONAL

ATOS (HOUSING) 1.1L, 4 CIL
SIN DEFROSTER (ANTI EMPAÑANTE)

05/UP

No. Original: 25622-02750



9505

NACIONAL Y AMERICANA

ATOS (HOUSING) 1.1L, 4 CIL
CON DEFROSTER (ANTI EMPAÑANTE)

05/UP

No. Original: 25622-02551



9506

NACIONAL Y AMERICANA

ATOS 1.1L, 4 CIL

05/UP

No. Original: 25611-02552



9507

NACIONAL Y AMERICANA

H100 DIESEL 2.5L, 4 CIL
(AJUSTADOR DE TERMOSTATO)
DIESEL

06/09

No. Original: 25125-42600

APLICA PARA HOUSING 9508



9506-KIT

TOMA DE AGUA 9506,
TUBO DE ENFRIAMIENTO 922756
Y MANGUERA 925630

ATOS 1.1L, 4 CIL

05/UP

No. Original: 25611-02552
25632-02756, 25630-02550



9508

NACIONAL Y AMERICANA

H100 2.5L, 4 CIL/ DIESEL
(HOUSING)

06/09

No. Original: 25127-42540

APLICA PARA TOMA DE AGUA 9507



9509

NACIONAL Y AMERICANA

H100 GASOLINA
(CONECTOR DE SALIDA DE AGUA)
2.4L, 4 CIL

03/05

No. Original: 25611-42550



TOMAS DE AGUA

HYUNDAI

TOMAS DE AGUA



9510

ATTITUDE 1.4 y 1.6L, 4 CIL
VERNA 1.6L, 4 CIL

05/11
TODOS

No. Original: 25611-26100
Ref.: 5202

9510-T



Ref.: 5202-T

**APLICA PARA HOUSING 9511
TERMOSTATO T- 9510**



9510-KIT

(T/A, HOUSING Y TERMOSTATO)

ATTITUDE 1.4 y 1.6L, 4 CIL
VERNA 1.6L, 4 CIL

05/11
TODOS

No. Original: 25611-26100,
25620-26160

Ref.: 5202-KIT

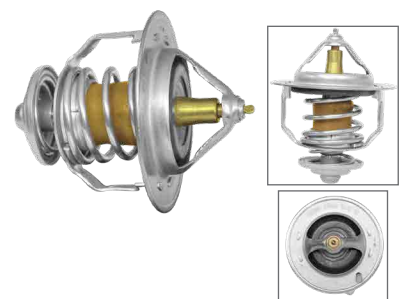

T-9510

ATTITUDE 1.4 y 1.6L, 4 CIL
VERNA 1.6L, 4 CIL
REF.: T-5202

05/11
TODOS

APLICA PARA TOMA DE AGUA 9510

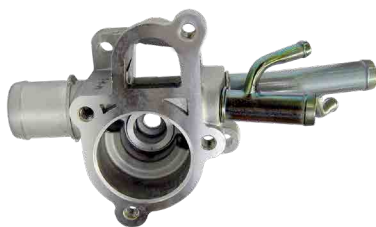

9511

ATTITUDE 1.4 y 1.6L, 4 CIL
VERNA 1.6L, 4 CIL

05/11
TODOS

No. Original: 25620-26160
Ref.: 5203

APLICA PARA 9510, 9510-T y T-9510



9512

ATOS 1.1L, 4 CIL

06/UP

No. Original: 25631-02550

**APLICA PARA TUBO 922756, y
MANGUERA 925630**



9513

ATTITUDE 1.4 y 1.6L, 4 CIL

12/UP

No. Original: 25631-2B051



9514

I-10
1.1L, 4 CIL

07/13

No. Original: 25632-02766



ISUZU Y SUBARU



9138

AMERICANA

ISUZU PICK-UP 1.8 y 2.0L GAS	81/87
ISUZU TROOPER 2.3L	84/85
I-MARK 1.8L GAS	81/84
CHEVY	75/81
PLYMOUTH	89

No.Original:
94201665, 94238380,
8-94238-380-0



9269

AMERICANA

SUBARU 2 DR. EXCEPT XT CAMIONETAS TODAS SUBARU TODOS	TODOS 85/89 85/87 80/84
---	----------------------------------

No.Original: 41754-7100



9401

AMERICANA

SUBARU BAJA 2.5L, 4 CIL	05/06
FORESTER 2.5L, 4 CIL	'05
IMPREZA 2.5L, 4 CIL	04/05
LEGACY 2.5L, 4 CIL	'05
OUTBACK 2.5L, 4 CIL	'00

No.Original: 11060-AA071

MAZDA



9137

AMERICANA

TRIBUTE DX 2.0L, 4 CIL	01/02
------------------------	-------

No. Original: F5RZ-8592-A
Ref: 7277



9146

AMERICANA

MAZDA 3.0L, 6 CIL	94/01
-------------------	-------

No. Original: XL5Z-8592 AB
Ref: 7279



9147

NACIONAL

TRIBUTE 2.0L, 4 CIL AUT. IMPORTADO	00/04
---------------------------------------	-------

No. Original: XS4Z-8592-AC
Ref: 7280



9148

NACIONAL

MAZDA 2.0 y 2.4L, 4 CIL CAMIONETA	97/02
--------------------------------------	-------

AMERICANA

MAZDA	91/97
-------	-------

No. Original: F0TZ-8592 CA
Ref: 7282



9149

**NACIONAL
CON SENSOR Y TERMOSTATO**

M-3, M-5, 2.0L, 4 CIL	03/UP
-----------------------	-------

No. Original: 1S7Z-8575-AG
Ref: 7285



TOMAS DE AGUA

ISUZU Y SUBARU/ MAZDA

TOMAS DE AGUA



9150

Ref: 7286
NACIONAL
SIN SENSOR Y CON TERMOSTATO

M-3, M-5, 2.0L, 4 CIL 03/UP

No. Original: 3Z-8575-B, 3M4Z-8575-B



9198

Ref: 7009
AMERICANA

MAZDA PICK-UP SERIES B 72/82
1000CC, 1200CC, 1600CC, 1800CC, 2000CC
y 2200CC 4 CIL

No. Original: D27Z-8592-B
0290-15-172A, 0290-15-1720



9199

AMERICANA
HOUSING

TRIBUTE 2.0L, 4 CIL 02/04
DOBLE ARBOL

No. Original: YS4Z-8592-BD
Ref.: 7273



9200

MAZDA 2 1.5L, 4 CIL 2016
MAZDA 3 2.0L, 4 CIL 2014

No. Original: PEDD-15-172



9201

AMERICANA

3, 5, 6 2.0L, 2.3L, 2.5L, 4 CIL 06/13
CX-7 2.5L, 4 CIL 10/12

No. Original: LF94-15-17Z



9260

AMERICANA

PICK-UP 81/85
626 TODOS 79/82

No. Original: 0222-15-172B
E0TZ-8592-C



9298

AMERICANA

MAZDA 626 TODOS
GAS 2.0L 83/87

No. Original: F801-15-161

MERCEDES B. NUEVO



4701

MERCEDES BENZ C230 2.5L & 3.0L V6	06/07
MERCEDES BENZ C300 3.0L V6	08/12
MERCEDES BENZ CLK350 3.5L V6	06/09
MERCEDES BENZ C350, E350, ML350 & R350 3.5L V6	06/11
MERCEDES BENZ GLK350 3.5L V6	10/12
MERCEDES BENZ ML450 3.5L V6	10/11
MERCEDES BENZ S400 3.5L V6	10/13
MERCEDES BENZ SLK280 3.0L V6	06/08
MERCEDES BENZ SLK300 3.0L V6	09/11
MERCEDES BENZ SLK350 3.5L V6	05/11



MITSUBISHI



9601

OUTLANDER 3.0L 6CIL & 2.4L, 4CIL LANCER 2.0L, 4CIL	07/17 09/13
---	----------------

No. Original: 1350A015

NUEVO

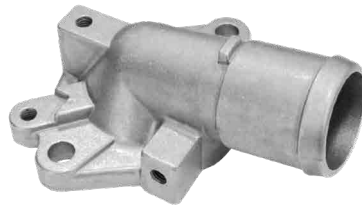

9602

GALANT, GRANDIS 2.4L, 4 CIL	03/10
-----------------------------	-------

No. Original: MN149478

NISSAN



9176

AMERICANA

NISSAN 510, 520, 521, 610, 620, 710 y 720 1595CC y 1770CC, 1.6 1.8L, 240Z y 260Z 2393CC y 2565CC 2.4 y 2.6L, 6 CIL

68/74

No. Original:
11060-U2001, 11060-U0100,
11060-21000



9179

Ref.: 179 y 4402

NACIONAL

PLATINA 1.6L, 4 CIL APRIO 1.6L, 4 CIL	03/UP 08/UP
--	----------------

AMERICANA

PLATINA 1.6L, 4 CIL	'03
---------------------	-----

No. Original: 77001-01179

9203



AMERICANA

NISSAN 810, MAXIMA LD28 2793CC LD28	79/84
NISSAN610, 620,720 y PICK-UP EXCEPT 81/82	79/85
720 L20B 1952CC, NISSAN 200 SX L20B 1952CC, 2.0L, NISSAN 510 L20B	74/82

No. Original:
11060-U6700, 11060-Y7010



9204

NISSAN 810 Y MAXIMA L24E
2393CC, 280Z Y 280ZX L28E
2753CC 6 CIL 2.4L y 2.8L,
200SX C/Z20E 1952CC
2.0 y 2.2L, 4 CIL

77/84

No. Original: 11060-P6500
11060-N4200

ALUMINIO



9179-A

NACIONAL

PLATINA 1.6L, 4 CIL APRIO 1.6L, 4 CIL	03/UP 08/UP
--	----------------

AMERICANA

PLATINA 1.6L, 4 CIL	'03
---------------------	-----

No. Original: 77001-01179



TOMAS DE AGUA

NISSAN

TOMAS DE AGUA



9207

AMERICANA

200SX C/Z20E 1952cc 2.0 y 2.2L 200SX 4 CIL C/Z22E 2187cc	80/83
--	-------

No. Original: 11060-N8400



9241

AMERICANA

PATHFINDER STANZA C/CA20S Y CA20E TODOS M10 VAN 200SX C/CA20E 1.8 TURBO PICK-UP TODAS 2.4L	87/89 82/89 85/86 84/89 83/89
--	---

No. Original: 11060-W7001



9249

AMERICANA

NISSAN 720, 820 PICK-UP PATHFINDER C/GAS Z20, Z22 Z24, 4 CIL	79/86
--	-------

No. Original: 11060-W7000



9250

NACIONAL

TSURU I B11, TSURU II B12 y TSURU III B13 8 VÁLVULAS MOTOR E-1500, 1600	84/92 84/UP
---	----------------

AMERICANA

NISSAN PULSAR 1.6L, SENTRA 1.5 y 1.6L, 4 CIL	83/88
---	-------

No. Original: 11060-01M00,
11060-B03G0
Ref.: 6004



9307

NACIONAL

TSURU III B13 FRONTAL MODELO INCLINADA SENTRA 16V STD/AUTM	92/UP 95/00
--	----------------

AMERICANA

TSURU 4 CIL	'92
-------------	-----

No. Original: 13049-F4300

APLICA PARA HOUSING 9317



9308

NACIONAL

D21 2.4 CAMIONETA 4 CIL 2.4L NP300 CHASIS NP300 DOBLE CABINA NP300 ESTACAS NP300 PICK UP 2.4L, 4 CIL	07/14
---	-------

AMERICANA

FRONTIER, XTERRA 4 CIL	98/04
------------------------	-------

No. Original: 13049-F4001



9309

AMERICANA

DATSUN 4 CIL 240Z, 260Z 224, 610, 620, Z-24, Z-200 2.0 y 2.4L, 4 CIL	68/74 80/88
--	----------------

INFERIOR
(DIAM. 0,642 MILÉSIMAS DE PULGADA)

No. Original: 13049-U0100



9310

AMERICANA

Z-24, Z-200 2.0 y 2.4L, 4 CIL SUPERIOR (DIAM. 0,738 MILÉSIMAS DE PULGADA)	80/88
--	-------

No. Original: 13049 -U6701

PARA SALIDA ANCHA 9323



9312

NACIONAL Y AMERICANA

TSURU I B11, TSURU II B12 y TSURU III B13, SENTRA MOTOR 16 VÁLVULAS E-1500, 1600	69/UP 94/01
---	----------------

No. Original: 11060-53Y00
Ref.: 6005



9311

NACIONAL Y AMERICANA

DATSUN Y NISSAN MOTOR J 1600 Y 1800 SEDÁN, SAKURA, SAMURAI, PICK-UP E ICHI-VAN.	69/UP
--	-------

No. Original: 11060-B2501



9315

NACIONAL

TSURU III B13 16V STD/AUTOM TSUBAME TRANS. AUTOMÁTICA	93/06 94/99
--	----------------

AMERICANA

PULSAR NX 1.6L, 4 CIL SENTRA 1.6L, 4 CIL	89/90 89/90
---	----------------

No. Original: 13049 - F4105

APLICA PARA HOUSING 9318



9316

NACIONAL Y AMERICANA

URVAN 2.4, 4 CIL, 16V	99/01
-----------------------	-------

No. Original: 13049-VJ260



9314

NACIONAL

TSUBAME y TSURU III B13 16V TRANS. STD	93/98
---	-------

AMERICANA

TSUBAME 1.3L, 4 CIL	94/98
---------------------	-------

No. Original: 13049 - F4100

APLICA PARA HOUSING 9318



TOMAS DE AGUA

NISSAN

TOMAS DE AGUA



9317

**HOUSING
NACIONAL Y AMERICANA**

TSURU III B13 y TSUBAME 1.6L, 4 CIL, 16V 92/18
NISSAN 311-1T

No. Original: 11061-F4300

APLICA PARA TOMA DE AGUA 9307



9318

**HOUSING
NACIONAL Y AMERICANA**

TSURU B13 BIII y TSUBAME 1.6L, 4 CIL 92/18
NISSAN 321-2T

No. Original: 11061-F4100

APLICA PARA T.A. 9314 Y 9315



9322

**NACIONAL
SIN TERMOSTATO**

FRONTIER V6, 4.0L 05/07
PATHFINDER V6, 3.5L, Y 4.0L 01/02
XTERRA V6, 4.0L 05/07

AMERICANA

INFINITI V6, 3.5, 07/08
FRONTIER Y PATHFINDER 4.0 01 y 05/08
XTERRA S, SE, X 05/08
FX35 Y G35 03/07
M35 SPORT 06/07
GRAND TOURING 03/07

No. Original: 13049-45100



9319

NACIONAL Y AMERICANA

URVAN 2.4L, 4 CIL, 16V 02/08

No. Original: 13049-VW100



9320

**NACIONAL Y AMERICANA
SIN TERMOSTATO**

ALTIMA V6, 3.5L 04/06
MÁXIMA V6, 6.5L 02/07
MURANO V6, 3.5L 02/07
QUEST V6, 3.5L 04/09

No. Original: 21200-8J10B

**9320-T
CON TERMOSTATO**

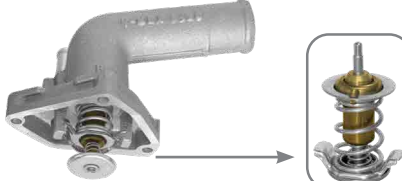

VENTA INDIVIDUAL DE TERMOSTATO T-9320

**9322-T
CON TERMOSTATO**

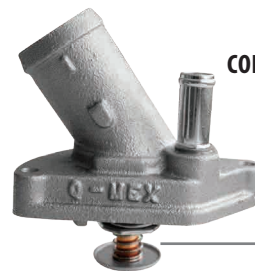

VENTA INDIVIDUAL DE TERMOSTATO T-9321



9321

NACIONAL SIN TERMOSTATO

MÁXIMA V6, 3.0L	95/01
INFINITI 130 V6, 3.0L	97/01
370Z 2.5L, 4 CIL	05/11

AMERICANA

MÁXIMA V6 3.0L	95/01
INFINITI 130 V6, 3.0L Y	99/01
PATHFINDER V6, 3.5	2001

No. Original: 13049-6P001



**9321-T
CON TERMOSTATO**



VENTA INDIVIDUAL DE TERMOSTATO T-9321

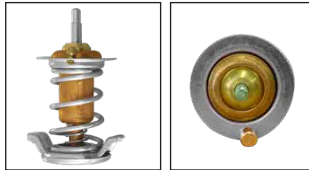
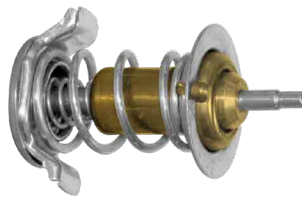

T-9320

NACIONAL Y AMERICANA TERMOSTATO

ALTIMA V6, 3.5L	04/06
MÁXIMA V6, 6.5L	02/07
MURANO V6, 3.5L	02/07
QUEST V6, 3.5L	04/09

APLICA PARA TOMA DE AGUA 9320

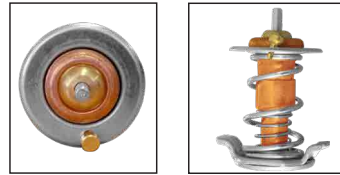
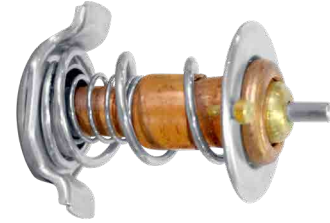

T-9321/22

NACIONAL

MÁXIMA V6, 3.0L	95/01
INFINITI 130 V6, 3.0L	97/01
370Z 2.5L, 4 CIL	05/11
NISSAN FRONTIER D22 V6, 4.0L	05/07
PATHFINDER V6 3.5L 01/02 y 4.0L	05/07
XTERRA V6, 4.0L	05/07

AMERICANA

MÁXIMA V6, 3.0L	95/01
INFINITI 130 V6, 3.0L	99/01
y PATHFINDER V6, 3.5	2001
INFINITI V6, 3.5	07/08
FRONTIER Y PATHFINDER 4.0	01 y 05 /08
XTERRA S, SE, X	05/08
FX35 y G35	03/07
M35 SPORT	06/07
GRAND TOURING	03/07

APLICA PARA TOMA DE AGUA 9321 y 9322



9323

NACIONAL Y AMERICANA

NISSAN Z24, Z200 2.0 y 2.4L, 4 CIL	80/88
------------------------------------	-------

**PARA SALIDA ANCHA
(DIAM. 1,000 MILÉSIMAS DE PULGADA)**

No. Original: 13049-U6701

PARA SALIDA DELGADA 9310



9324

HOUSING NACIONAL

TSURU I B11, TSURU II B12 y TSURU III B13 8V	84/92
MOTOR E-1500, 1600	84/UP

AMERICANA

NISSAN PULSAR 1.6L, SENTRA 1.5 y 1.6L, 4 CIL	
--	--

No. Original: 11061-01M15

APLICA PARA TOMA DE AGUA 9250



9325

NACIONAL

ALTIMA MOT. QR2SDE 2.5L, 4 CIL	01/06
--------------------------------	-------

No. Original: 13049-3Z001



TOMAS DE AGUA

NISSAN

TOMAS DE AGUA



9326

NACIONAL

ROUGE MOT. QR2SDE 06/11
2.5L, 4 CIL

No. Original: 13049-JA01A, 13049-JA00A



9327

NACIONAL

TIIDA SEDÁN MOT. QG18DE 1.8L, 4 CIL y 07/16
B16 MOT. MR20DE 2.0L, 4 CIL

No. Original: 13049-ET000



9328

NACIONAL

FRONTIER D22 MOT. QR25DE 05/11
2.5L, 4 CIL

No. Original: 13049-EA000



9329

PICK UP, 07/09
ESTAQUITAS D21 2.4 L, 4 CIL

No. Original: 11060 F450A

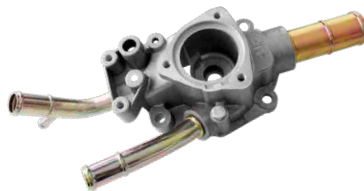

9330

HOUSING

SENTRA 1.8L, 4 CIL 02/06

No. Original: 11061-F460B

APLICA PARA TOMA AGUA 9338

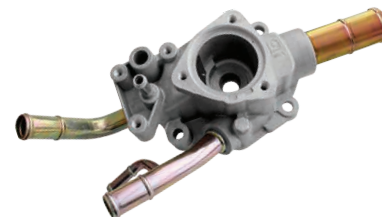

9331

HOUSING

SENTRA 1.8L, 4 CIL 01/02

No. Original: 11060-4Z015

APLICA PARA TOMA AGUA 9338



9332

NACIONAL

TSURU III B13 1.6L, 4 CIL 92/10

No. Original: 13049-53J00
13049-64Y00



9333

NACIONAL Y AMERICANA

QUEST 3.0L, 6 CIL 92/98
CAMIONETA FORD VILLAGER 3.0L, 6 CIL 92/98

No. Original: 11061-0B010



9335

AMERICANA

INFINITI Q45 4.5L, 8 CIL 90/96

No. Original: 13049-60U00



9334

AMERICANA

2005X 3.0L, 6 CIL	87
300ZX 3.0L, 6 CIL	84/89
PATHFINDER 3.0L, 6 CIL	87
D21 PICK UP 3.0L, 6 CIL	84/86
FRONTIER 3.0L, 6 CIL	99/04
PICK UP 3.0L 6 CIL	95/96
XTERRA 3.0L, 6 CIL	00/04
INFINITI M30 3.0L, 6 CIL	90/92
INFINITI QX4 3.0L, 6 CIL	97/01

No. Original: 13049-V5000



9336

HOUSING NACIONAL

TSURU II B12 1.6L, 4 CIL	87/88
--------------------------	-------

No. Original: 11061-01M12

APLICA PARA 9250



9337

HOUSING NACIONAL

TSURU III B13 1.6L, 4 CIL	92/97
---------------------------	-------

No. Original: 11061-01M10
11061-17M10

APLICA PARA 9250



9338

SENTRA B15 1.8L, 4 CIL	01/06
------------------------	-------

No. Original: 13049-4Z000

APLICA PARA 9330 y 9331



9339

NACIONAL

NV2500 /DIESEL 5.6L, NV3500 /GASOLINA 8 CIL	13/UP
--	-------

No. Original: 13049-AR000



9341

SIN TERMOSTATO

PATHFINDER 3.0L, 4 CIL
PATHFINDER 3.3 y 3.5L, 6 CIL

No. Original: 21200-9HP0A



**9341-T
CON TERMOSTATO**



9340

VERSA 1.6L, 4 CIL	12/UP
-------------------	-------

No. Original: 13048-3HC0A



9342

MARCH 1.6L, 4 CIL	11/15
NOTE 1.6L, 4 CIL	14/15
SENTRA 1.6L, 4 CIL	13/15
VERSA, JUKE, TIIDA 1.6L, 4 CIL	12/UP

No. Original: 13049-ED02A



TOMAS DE AGUA

NISSAN/ PEUGEOT

TOMAS DE AGUA



9343

MICRA 1.4, 1.6 y 1.8L, 4CIL 05/10

No. Original: 11060-BX00A



9344

D22X 2.4L 4 CIL 09/15
URVAN GASOLINA 2.4L, 4 CIL 01/06

No. Original: 11060-VJ201

NUEVO



9345-1

VERSA 1.6L 4 CIL 12/19
MARCH 1.6L 4 CIL 12/21

No. Original: 21418-1HK3A

PEUGEOT



4001

NACIONAL Y AMERICANA

PEUGEOT 304 1.4, 1.6 y 2.0L, 16V 00/07
406 y 607 2.2L, 16V 00/07
206 2.0L, 16V 00/02
307 2.0 y 2.2L, 16V 92/07

No. Original: 8714C-C1

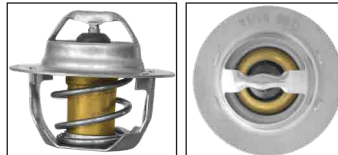
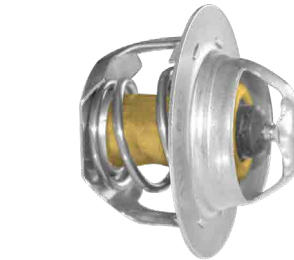

T-4001

NACIONAL Y AMERICANA

PEUGEOT 304 1.4, 1.6 y 2.0L 16V 00/07
406 y 607 2.2L, 16V 00/07
206 2.0L, 16V 00/02
307 2.0 y 2.2L, 16V 92/07

APLICA PARA TOMA DE AGUA 4001



**4001-T
CON TERMOSTATO**



VENTA INDIVIDUAL DE TERMOSTATO T-4001



4002

NACIONAL Y AMERICANA

PEUGEOT 205 y 309 1.9L, 4 CIL 92/UP
PEUGEOT 206 1.9L, 4 CIL 98/UP

No. Original: 9609493180



4003

NACIONAL Y AMERICANA

PARTNER 1ERA GENERACIÓN 02/06
1.6L, 4 CIL

No. Original: 9654775080,1336W3

TOMAS DE AGUA

PEUGEOT/RENAULT / TOYOTA



TOMAS DE AGUA



4004

**NACIONAL Y AMERICANA
CON SENSOR Y TERMOSTATO**

PARTNER y PEUGEOT 206 1.6L, 4 CIL 06/UP

No. Original: 9647265980



4005

NACIONAL Y AMERICANA

PARTNER y PEUGEOT 206 1.6L, 4 CIL 06/UP

No. Original: 1336Z00

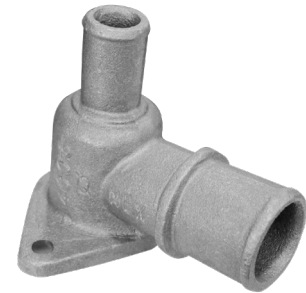

4006

PEUGEOT 206 L4 1.6L 01/09

No. Original: 9627629080,
9801622180

RENAULT

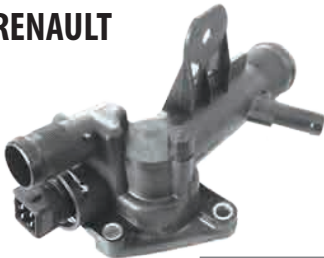

4401

**NACIONAL Y AMERICANA
CON SENSOR Y TERMOSTATO**

CLIO II
KANGOO,
MEGANE II 1.6, 4 CIL DCI 02/07

No. Original: 8200267349



4402

NACIONAL

CLIO 1.6, 4 CIL 03/UP

No. Original: 7700101179
Ref.:179 y 9179

TOYOTA



9143

AMERICANA

CELICA, CORONA, CORONA MARK II,
HILUX 8R, 8RC 1858CC, 19RC,
1968CC 1.9, 2.0L, 4 CIL 69/74

No. Original: 16331-33010



TOMAS DE AGUA

TOYOTA

TOMAS DE AGUA



9144

AMERICANA

COROLLA 1600CC MOTOR 16 V CARINA E-1500, E-1600	70/79 TODOS 71/73
---	-------------------------

No. Original: 16331-31010



9145

NACIONAL

HILUX 3Y, 4Y, 4-RUNER 2.0L, y 2.2L	84/90
---------------------------------------	-------

No. Original: 16331-71010

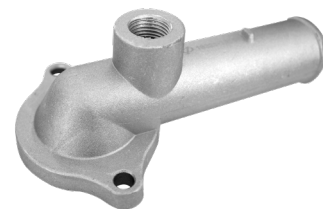

9151

NACIONAL

COROLLA 4 CIL	93/97
---------------	-------

AMERICANA

CELICA COROLLA 1.8L, 4 CIL	94/97 93/97
-------------------------------	----------------

No. Original: 16321-15040



9152

NACIONAL

PASEO, TERCEL 4 CIL	89/99
---------------------	-------

AMERICANA

TOYOTA PASEO 1.5L, 4 CIL	92/98
--------------------------	-------

No. Original: 16321-10011



9153

NACIONAL

PASEO, TERCEL 1.5L, 4 CIL	89/99
---------------------------	-------

AMERICANA

TOYOTA PASEO 1.5L, 4 CIL	92/98
--------------------------	-------

No. Original: 16321-11011



9154

NACIONAL

4 RUNNER 2.7L, 4 CIL, TACOMA 6 CIL	95/04
---------------------------------------	-------

AMERICANA

TOYOTA 4 RUNNER 2.7L, 4 CIL TOYOTA TACOMA 2.4 y 2.7L, 4 CIL	00 00/04
--	-------------

No. Original: 16321-0W010



9155

NACIONAL

TERCEL 1.5L, 4 CIL	91/94
--------------------	-------

No. Original: 16333-11160



9156

NACIONAL

PASEO, TERCEL 1.5L, 4 CIL	91/99
---------------------------	-------

No. Original: 16333-11200



9157

NACIONAL

4RUNNER AMERICANA 6 CIL 89/95

AMERICANA

TOYOTA 4RUNNER 6 CIL 3.0L; 6 CIL 3.4L, PICKUP 3.0L, 6 CIL TOYOTA T100 3.0L, 6 CIL	88/95 '96 89/95 93/94
--	--------------------------------

No. Original: 16321-65030



9158

NACIONAL

COROLLA, MATRIX, MR2 4 CIL 98/08

AMERICANA

TOYOTA CELICA COROLLA Y MATRIX MR2 SPYDER 1.8L, 4 CIL	00/05 03/07 00/05
---	-------------------------

No. Original: 16321-22070



9159

NACIONAL

CAMRY, MATRIX, SOLARA 4 CIL 04/09

AMERICANA

TOYOTA CAMRY 2.4L, 4 CIL TOYOTA HIGHLANDER 2.4L, 4 CIL RAV4 2.4L, 4 CIL SOLARA 2.4L, 4 CIL	05/07 '07 07 06/07
---	-----------------------------

No. Original: 16321-0H011



9160

NACIONAL

SIENNA 3.5L, 6 CIL 04/10

AMERICANA

LEXUS RX333 SIENNA 3.3L, 6 CIL	04/06 04/06
-----------------------------------	----------------

No. Original: 16321-0A040



9161

NACIONAL Y AMERICANA

LEXUS LS400, SC 400, 4.0L, 8 CIL 90/99

No. Original: 16321-50010



9162

CAMRY 4 y 6 CIL RAV4 6 CIL RAV4 4 CIL SIENNA 6 CIL	07/11 06/12 13/UP 11/UP
---	----------------------------------

No. Original: 16321-36010
16321-0V010



TOMAS DE AGUA

TOYOTA

TOMAS DE AGUA



9163

YARIS 1.5L, 4 CIL 07/14

No. Original: 16502-21070



9164

COROLLA 1.8L, 4 CIL 07/13

No. Original: 16577-22030



9175

AMERICANA

CELICA 2189CC CORONA EXCEP MARK II, HILUX 20R PCK-UP EXCEP 4 RUNNER 2.2L, 4 CIL 77/09

No. Original: 16331-38011



9193

AMERICANA

CELICA, CORONA, HILUX W/20R, 2189CC. MOTOR DE 8/79 A 8/70. 4 CIL 80/81

No. Original: 16331-38012



9205

AMERICANA

CELICA, CORONA 22R 8/80, HILUX 22R 8/80 2366CC, EXCEPT CALIFORNIA 81/82

No. Original: 16331-35020, 16331-35030



9273

AMERICANA

CRESSIDA, SUPRA W/4ME y 5ME TODOS 79/81

No. Original: 16331-45030



9286

AMERICANA

4 RUNNER W/EFI '84
CELICA W/EFI 83/85
4WD PICK-UP & '88
4 RUNNER W/EFI
PICK-UP W/EFI 84/87
PICK-UP & 4 RUNNER W/EFI 2.4L, 4 CIL 89/90

No. Original: 16331-35040



9289

AMERICANA

CRESSIDA, SUPRA 82/88
TODOS C/5MGE 2.8L, 6 CIL

No. Original: 16331-43010



9293

AMERICANA

COROLLA COUPE, 83/88
SR5 4AC 2 BBL 1.6L,
TERCEL 3A, AC LOWER 1.5L, 4 CIL

No. Original: 16323-15020



9306

AMERICANA

VAN TODAS 2.0 y 2.2L, 4 CIL

84/90

No. Original: 16321-71010



8095

AMERICANA C/ROSCA

ALL AMC, EXCEPT 360 CALIFORNIA & 1976 401 ENGINE, ALL AMC, EXCEPT 360 CALIFORNIA & 1976 401 ENGINE, ALL AMC, EXCEPT 360 CALIFORNIA & 1976 401 ENGINE
ALL JEEP, ALL JEEP 8 CIL

67/80

70/79

No. Original: 3210 852

VAM=AMC

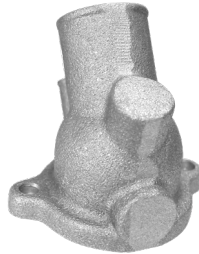

8076

AMERICANA

AMX CONCORDE 5.0L, 8 CIL
GREMLIN HORNET 5L, 8 CIL
MATADOR 5.0L y 5.9L, 8 CIL
MATADOR 5.9L, 8 CIL
PACER 5.0L, 8 CIL
SPIRIT 5.0L, 8 CIL
JEG CJS y CJ7 5.0L, 8 CIL

78/99
76
76
78
68/79
79
76/78

No. Original: 3928220



8077

NACIONAL

RAMBLER 6 CIL

63/83

AMERICANA

AMC TODOS 199 3.3L,
232 3.8L, 258 4.2L

68/80

JEEP TODOS 2.58 4.2L, 6 CIL

68/88

No. Original: 2525055
Ref.: 9718



8105

AMERICANA

ALL AMC, EXCEPT 360 CALIFORNIA
ALL AMC (3.8L) & (4.2L) 6 CIL
ALL JEEP (3.8L) & (4.2L) 6 CIL
AMC ENGINE

75/80

No. Original: 3224 216



8106

AMERICANA

JEEP TODOS SERIE J 6 CIL
230

72/73

No. Original: 800293



TOMAS DE AGUA

VAM=AMC/ VOLKSWAGEN

TOMAS DE AGUA



8178

NACIONAL Y AMERICANA

AMC y JEEP TODOS 258 4.2L, 151 2.5L JEEP CHEROKEE COMANCHE, WAGONNER 4.0L MOTOR 282 SERIE J	81/90 88/90
No Original: 3235347, 8134147 2032310 Ref.: 5347, 9136	



8179

AMERICANA SIN ROSCA

JEEP TODOS 304 5.0L, 360, 5.9L V-8	80/93
CHEVY Y GMC 66	80/91
No. Original: 3238509	

VOLKSWAGEN



087

REPARTIDOR DE AGUA

NACIONAL

JETTA A4 1.8L, 4 CIL	99/15
No. Original: 1J0-121-087	



087-A

**REPARTIDOR DE AGUA
(CON ENTRADA PARA SENSOR)**

NACIONAL Y AMERICANA

GOLF, JETTA A4 2.0L, 4 CIL	99/03
No. Original: 1J0-121-087-A	



087-B

REPARTIDOR DE AGUA

NACIONAL Y AMERICANA

GOLF, JETTA A4 1.4L, 1.6L, 2.3L y 1.9L, 4 CIL DIESEL (MANUAL, SIN AIRE ACONDICIONADO)	99/03
No. Original: 1J0-121-087-B	



087-C

COPEL REPARTIDOR DE AGUA

NACIONAL Y AMERICANA

GOLF, JETTA A4 1.8L, 4 CIL NEW BEETLE, DERBY	99/03 01/05
No. Original: 1J0-121-087-C	



087-D

CODO DE AGUA

NACIONAL

VR6 EUROVAN T5 TDI 1.9L, 6 CIL	06/09
No. Original: 1J0-121-087-D	



087-E

NACIONAL

NEW BEETLE 2.0L, 4 CIL (TAPADA)	00/07
No. Original: 1C0-121-087-B	



087-F

NACIONAL

NEW BEETLE NB TURBO 1.8L, 4 CIL (ABIERTA)	00/07
No. Original: 1C0-121-087	

TOMAS DE AGUA

VOLKSWAGEN



TOMAS DE AGUA



087-G

NACIONAL

COPLE BORA 2.5L, 4 CIL

05/10

No. Original: 1K0-121-087-E



087-H

CODO DE AGUA GRANDE

NACIONAL

BORA 2.0L, 4 CIL

05/09

No. Original: 1K0-121-087-H



087-K

CODO DE AGUA

GOLF 1.4L, 4 CIL

JETTA 1.4L, 4 CIL

JETTA CLÁSICO 1.4L, 4 CIL

99/01

01/05

02/05

Original: 1J0-121-087-K

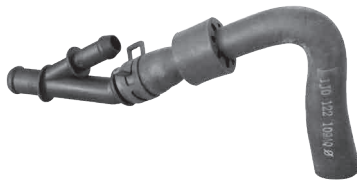

109-AQ

CODO DE AGUA EN FORMA DE "Y" CON MANGUERA

NACIONAL

GOLF, JETTA A4 y SHARAN,
AUDI TURBO 1.8L, 4 CIL

00/05

No. Original: 1J0-122-109-AQ

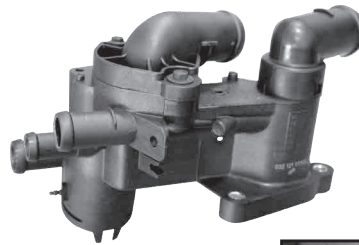

111-AP

CON HOUSING Y CONECTOR

**(SIN PIPETA, CON TAPONES,
SIN TERMOSTATO)**

NACIONAL

POLO 1.4L, 4 CIL

SEAT IBIZA

02/08

No. Original: 032-121-111-AP

APLICA PARA TERMOSTATO T-111

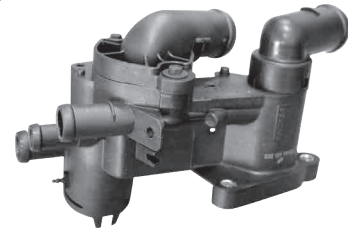

111-B

(SIN PIPETA, SIN TAPONES, CON TERMOSTATO)

GOL 1.8 y 2.0L, 4 CIL

GOL SEDÁN

PARA SENSOR SUPERIOR

CROSS FOX

PARA SENSOR INFERIOR

SPORTVAN 1.6L, 4 CIL

SAVEIRO 1.6L, 4 CIL

09/UP

09/UP

TODOS

06/UP

10/UP

No. Original: 032-121-111-B,
032-121-111-BJ y 032-121-111-CK

APLICA PARA TERMOSTATO T-111



TOMAS DE AGUA

VOLKSWAGEN

TOMAS DE AGUA

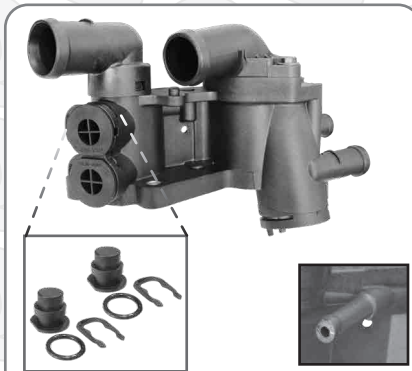

111-CL

CON HOUSING Y CONECTOR

(CON SALIDA, SIN TERMOSTATO, INCLUYE TAPONES)

PIPETA LATERAL, 6 SALIDAS, 2 BULBOS

POLO 2.0L, 4 CIL	01/07
CROSS FOX 1.6L, 4 CIL	05/UP
LUPO 1.6L, 4 CIL	05/09

No. Original: 032-121-111-CL

APLICA PARA TERMOSTATO T-111

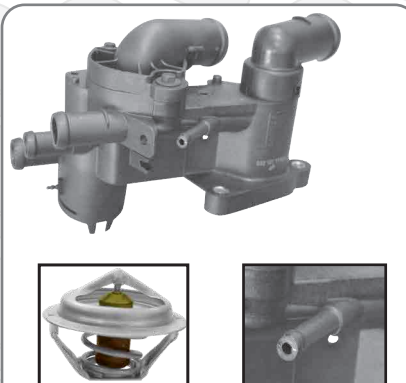

111-CL-T

(CON SALIDA, SIN TAPONES, CON TERMOSTATO)
PIPETA LATERAL, 6 SALIDAS, 2 BULBOS

POLO 2.0L, 4 CIL	01/07
CROSS FOX 1.6L, 4 CIL	05/UP
LUPO 1.6 L, 4 CIL	05/09

No. Original: 032-121-111-CL

APLICA PARA TERMOSTATO T-111

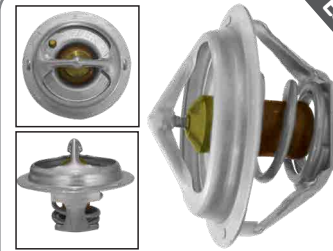

PRECIO ESPECIAL

T-111

Ref.: 3212.83

POLO 2.0L, 4 CIL	01/07
CROSS FOX 1.6L, 4 CIL	05/UP
LUPO 1.6L, 4 CIL	05/09

**APLICA PARA: 111-AP y 111-B
111-CL Y L-T**



111-F

NACIONAL

AUDI A3 L4 2.0L	06/08
VW GTI L4 2.0L	06/09

No. Original: 06F-121-111-F

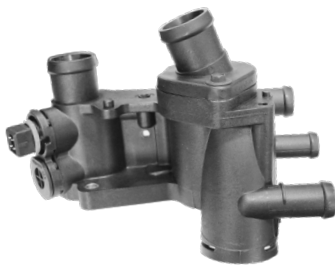

111-N

NACIONAL

GOLF A4	97/05
VARIANT	99/06
LUPO	98/05
POLO	94/99
VENTO	95/98
POLO CLASSIC 4 CIL	95/01

AMERICANA

CADDY II	95/04
POLO CLASSIC ALM 1.6L	97/02
OTTO AER 1.0L	77/99

No. Original: 032-121-111-N



111-AM

VENTO 1.6L, 4 CIL	15/UP
-------------------	-------

No. Original: 03C-121-111-AM



114

VANAGON T25 1900cc & 2100cc	79/92
-----------------------------	-------

No. Original: 025-121-114



NUEVO

115

VANAGON T25 2100 CC	85/92
No. Original: 025-121-115	

117-A

HOUSING
3 BULBOS, 2 SALIDAS

NACIONAL

CORRADO 2.9L, VR6	92/95
GOLF/JETTA A3 2.8L, VR6	93/98
PASSAT 2.8L, VR6	92/97
EUROVAN T4 2.8L, VR6, 6 CIL	96/01

No. Original: 021-121-117-A

117-C

NACIONAL POLO 1.6L, 4 CIL	87/94
AMERICANA GOLF, JETTA	87/94
No. Original: 030-121-117-C	

117-D

NACIONAL GOLF, JETTA A2 1.8L, 4 CIL	83/92
AMERICANA GOLF Y JETTA HZ, MH, NV, 2C POLO HZ, MH, NV, 2G, AAK	86/97 82/90
No. Original: 030-121-117-D	

117-E

HOUSING
2 SALIDAS, 2 BULBOS

NACIONAL

EUROVAN VR6, JETTA A4, 2.8L, 6 CIL	00/04
PASSAT VR-6	92/99

No. Original: 022-121-117-C

117-M

NACIONAL POLO 1.6L, 4 CIL	85/94
AMERICANA GOLF, JETTA	91/94
No. Original: 030-121-117-M	

117-N

NACIONAL GOLF A3 1.4 y 1.6L VENTO 1.4 y 1.6L SEAT CORDOBA 1.4 y 1.6L, 4 CIL	91/99 91/98 93/99
No. Original: 030-121-117-N	



TOMAS DE AGUA

VOLKSWAGEN

TOMAS DE AGUA



118-D

NACIONAL

POLO 1.4L, 4 CIL 02/08

No. Original: 032-121-118-D



120

NACIONAL

A3, DERBY 1.8L, 4 CIL 93/99

No. Original: 037-121-121-A



121

NACIONAL Y AMERICANA

FRONTAL GOLF, JETTA A4, NEW BEETLE 2.0L, 4 CIL 98/UP

No. Original: 038-121-121



121-A

NACIONAL Y AMERICANA

JETTA A3, PASSAT VR6 2.8L, 6 CIL 93/99
GOLF 95/00
EUROVAN T4 99/00

No. Original: 021-121-121-A



121-C

NACIONAL

CODO BOMBA DE AGUA

A4, NEW BEETLE y POLO 2.0L 00/UP

AMERICANA

NB, GOLF, GOLF GTI 1.8L y 2L, 4 CIL 01/06
NB TURBO-S 1.8L, 4 CIL 00/04
GOLF GL Y GLS 2.0L, 4 CIL 04/05
GOLF JETTA 1.8L y 2L, 4 CIL 00/04
JETTA GLS 1.8L y 2L, 4 CIL 06/07
PASSAT Y TOUAREG V6, 3.6L
SALIDA DE AGUA DEL MOTOR HACIA EL TERMOSTATO.

No. Original: 06A-121-121-C



121-D

CODO DE BOMBA DE AGUA

NACIONAL

PASSAT, A3, T2A 97/00

AMERICANA

PASSAT 1.8L, 4CIL 98/01
AUDI, A4, QUATTRO 1.8L, 4 CIL 97/01

No. Original: 030-121-121-B



121-B

CODO BOMBA DE AGUA

NACIONAL

POINTER 1.6 y 1.8L, 4 CIL 98/UP

No. Original: 026-121-121-A



121-E

NACIONAL

GOLF, JETTA A4	99/06
NEW BEETLE	99/06
SHARAN	02/UP
AUDI A3	96/01

AMERICANA

NEW BEETLE BSW, BEW	98/06
BORA BKC, BXE, GOLF, AJM, AVY,	99/07
ATD JETTA AXR	02/08
VARIANT	01/09
SHARAN AWV, AVY, ASZ, BTB,	
EUROVAN AXB, AXC, BRR, BRS 1.9	
AUDI A3 BKC, BXE 1.9	

No. Original: 038-121-121-D



121-F

Ref.: 9139

CODO BOMBA AGUA

NACIONAL

VW 1.6L, 1.8L	ENF/AGUA	77/93
---------------	----------	-------

AMERICANA

JETTA, RABBIT, PICK-UP RABBIT,	80/83
QTUM, SCIROCCO 1.5, 1.6, 1.7 y 1.8L	
AUDI	81/90
VW	75/93

No Original: 055-121-121-F
055-121-121, 055-121-121-A



121-G

CODO BOMBA AGUA

NACIONAL

EUROVAN T4 2.5L, 5 CIL	91/03
------------------------	-------

No. Original: 074-121-121-B



121-H

NACIONAL

GOLF A3 1.6L	92/98
POLO 1.6L, 4 CIL	95/01

AMERICANA

GOLF, POLO VENTO

No. Original: 032-121-121-A

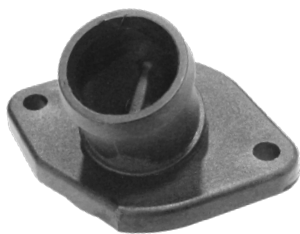

121-J

NACIONAL

BORA	00/05
GOLF A4 Y LUPO	98/05
POLO 4 CIL	03/05

AMERICANA

GOLF AHW, AKQ, APE, AT, AUS,	99/01
AXP 1.4 16V	
VARIANT AHW, AZD, 1.4 1.6 16V	01/05
POLO CLASSIC ADD, ADC 1.8	97/02

No. Original: 032-121-121-J



121-K

NACIONAL

POLO 1.4L, 4 CIL	02/08
SEAT, IBIZA	

AMERICANA

POLO 1.4L, 4 CIL	02/08
------------------	-------

No. Original: 032-121-121-K



121-L

NACIONAL

BORA 2.0L y 2.5L, 4 y 5 CIL	06/10
GOLF A4 2.0L, 4 CIL,	04/09
JETTA A4 1.4L 2.5L, 4 CIL	06/10
PASSAT 1.6, 2.0L, 4 CIL	06/10
TOURAN 1.6L, 4 CIL	07/10

No. Original: 03L-121-121-A



TOMAS DE AGUA

VOLKSWAGEN

TOMAS DE AGUA



121-M

NACIONAL

BORA 2.5L, 5 CIL	00/UP
JETTA A4 2.5L, 5 CIL	06/08
BEETLE 2.5L, 5CIL	06/10

AMERICANA

JETTA 2.5L, 5 CIL	06/07
BEETLE 2.5L, 5 CIL	05/07
RABBIT 2.5L, 5 CIL	06/07

No. Original: 07K-121-121-B



131

NACIONAL Y AMERICANA

FRONTAL GOLF, JETTA 1.8L, 4 CIL <i>SIN AIRE ACONDICIONADO</i>	88/90
GOLF, JETTA TDI PF, RV	92/98
PASSAT ST TDI	88/93
POINTER TDI BGG,	94/06
EUROVAN ABL	00/04

No. Original: 068-121-132
068-121-133-AB



132

NACIONAL Y AMERICANA

1 BULBO, 3 SALIDAS

GOLF, JETTA A4, SEAT LEON, TOLEDO 2.0L, 4 CIL	99/04
POLO 2.0L CORDOBA, IBIZA	01/05

No. Original: 06A-121-132



132-A

NACIONAL

PASSAT	96/00
AUDI A4 1.6L, 4 CIL	95/00

AMERICANA

PASSAT 4/MOTION AHL, ARM, APV 1.6	97/00
AUDI, A4 AHL 1.6	95/99

No. Original: 050-121-132-A



132-B

NACIONAL

FRONTAL GOLF, JETTA A2 Y T2A, COMBI Y CORSAR T3 (3 BULBOS, 2 SALIDAS) 1.8L, 4 CIL	84/93
---	-------

AMERICANA

RABBIT 1.8L, 4 CIL	84/93
--------------------	-------

No. Original: 037-121-132-B



132-C

NACIONAL

BORA	98/05
GOLF A4	97/06
POLO	96/01
AUDI A3	96/01
SEAT CORDOBA, IBIZA	99/02
LEÓN	99/06
TANSPORTER 1.9L, 4 CIL	05/09

AMERICANA

AUDI, A3	97/03
EUROVAN	03/10
NEW BEETLE TDI	98/05
SPORT VAN 1.9	06
DERBY, GOLF y JETTA TDI	99/06

No. Original: 038-121-132-C



132-D

NACIONAL Y AMERICANA

JETTA A4 TURBO y GOLF GTI SEAT LEON, TOLEDO TRANS. STD Y AUTOMÁTICO	98/UP 99/06
No. Original: 06A-121-132-D	



132-E

NACIONAL

EUROVAN-PANEL T4 2.4 y 2.5L, 5CIL (GAS Y DIESEL) TRANS. MANUAL. (2 BULBOS, 1 SALIDA)	00/07
---	-------

AMERICANA

TRANSPORTER T4 y LT 5 CIL 2.8L	91/98 97/01
-----------------------------------	----------------

No. Original: 074-121-132



132-F

NACIONAL

PASSAT (3B2) AUDI A4 (8D2, B5) 1.6L, 4 CIL	00/07 00/07
---	----------------

AMERICANA

PASSAT AUG 1.8 AUDI A4 AWT 1.8 AUDI A6 APV, AEB, AWT 1.8	98/01 99/01 98/01
--	-------------------------

No. Original: 058-121-132-A
058-121-132-B, 058-121-132-C



132-G

NACIONAL Y AMERICANA

NEW BEETLE 2.0L, JETTA A4 2.0L, GOLF MOTOR AEG 4 CIL NEW BEETLE 2.0L, 4 CIL MOTOR TURBO 1.8L 1 BULBO 3 SALIDAS	01/10 00/05
--	----------------

No. Original: 06A-121-132-C



132-I

NACIONAL Y AMERICANA

EUROVAN T4 2.4 y 2.5L 4 CIL y 5 CIL	90/03
--	-------

No. Original: 074-121-132-B



132-J

NACIONAL Y AMERICANA

GOLF JETTA A4 PASSAT POLO TOURAN 1.6L, 4 CIL	04/09 06/08 06/10 05/10 03/10
---	---

No. Original: 038-121-132-G



132-H

NACIONAL Y AMERICANA

POLO LUPO 1.6L, 4 CIL	98/05 94/99
--------------------------	----------------

No. Original: 028-121-132-C



TOMAS DE AGUA

VOLKSWAGEN

TOMAS DE AGUA



132-K

NACIONAL

SEAT IBIZA 2.0L, 4 CIL 00/05

No. Original: 050-121-132-B



132-L

NACIONAL

JETTA A3 Y A4 4 CIL 2.0L	92/02
PASSAT 2.0L, 4 CIL	94/97
POLO 2.0L, 4 CIL	96/00
VENTO 2.0L, 4 CIL	92/98

No. Original: 028-121-132-A

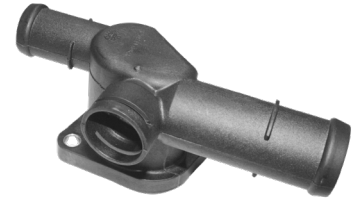

132-M

NACIONAL

JETTA GTI 2.0L, 4 CIL	06/09
JETTA 2.0L, 4 CIL	11/14

No. Original: 172-401-320-AG



132-N

BORA, PASSAT, TIGUAN 2.0L, 4 CIL 10/UP

No. Original: 06J-121-132-G

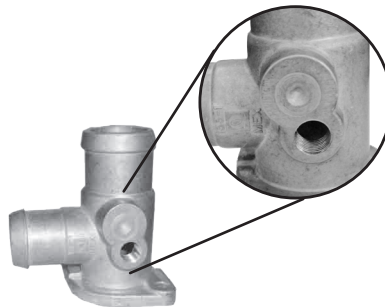

133

NACIONAL

CARIBE ATLANTIC A1 1800 GOLF A2, JETTA A2	87/90
GOLF A3, JETTA A3 1.8L, 4 CIL	93/99
2 BULBOS, 2 SALIDAS	

AMERICANA

GOLF, JETTA 1.8L, 4 CIL 87/90

No. Original: 026-121-133-D



133-A

NACIONAL Y AMERICANA

GOLF A2 1.8L, 4 CIL	82/93
AUDI 80 1.8L, 4 CIL	84/86
AUDI COUPE 1.8L, 4 CIL	84/88

No. Original: 027-121-133
027-121-133-A



132-P

NACIONAL

SEAT Y JETTA A4 1.8L, 4 CIL 00/05

No. Original: 06A-121-132-P



132-TA

NACIONAL Y AMERICANA

KIT DE TAPONES. TOMA DE AGUA
(TAPÓN, ORING, SEGURO, 3 PIEZAS C/U)



133-AH

NACIONAL Y AMERICANA

GOLF A4 GTI	02/06
JETTA	04/05
JETTA A4 GLS	02/03
AUDI TT 2.0L, 4 CIL	03/06
LEON MOTOR 1.8 TURBO (3 SALIDAS, 1 BULBO)	

No. Original: 06A-121-133-AH

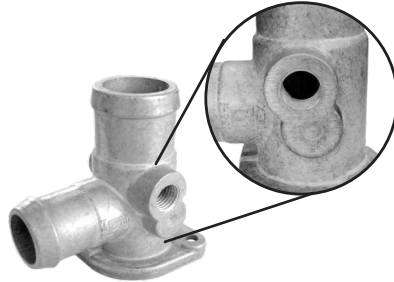

133-1

NACIONAL

POINTER 1.8L, 4 CIL	97/05
POINTER CITY y DERBY VAN	91/08

AMERICANA

POINTER 1.8L, 4 CIL	97/05
---------------------	-------

No. Original: 126-121-133-1



133-B

NACIONAL

(2 BULBOS, 2 SALIDAS)

JETTA A2 1.8L, 4 CIL	87/92
----------------------	-------

No. Original: 037-121-132-B,
037-121-133-B



133-BC

NACIONAL

PASSAT 1.8L, 4 CIL	-/02
AUDI 1.8L, 4 CIL	
(BASE CORTA 8 cm)	

No. Original: 06B-121-133-D



133-BL

NACIONAL

PASSAT 1.8L, 4 CIL	03/UP
AUDI 1.8L, 4 CIL	
(BASE LARGA 9 cm)	

No. Original: 06B-121-133-D



133-C

NACIONAL Y AMERICANA

PASSAT 2.0L, 4 CIL	88/99
T2A, A2 GTI	
(2 BULBOS)	

No. Original: 037-121-133-C



133-D

NACIONAL Y AMERICANA

A3 GOLF-JETTA VR6 (TRIANGULAR) 1.8L, 4 CIL	93/99
---	-------

No. Original: 021-121-133-D

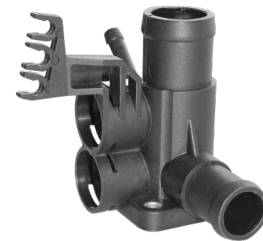

133-E/F

NACIONAL Y AMERICANA

FRONTAL GOLF, JETTA A2 y A3 1.8L 4 CIL C/PEINE	88/93
--	-------

No. Original: 037-121-133-E/F



TOMAS DE AGUA

VOLKSWAGEN

TOMAS DE AGUA



133-E

NACIONAL

PASSAT	96/00
AUDI A4	95/00
A4 AVANT	96/01
A6 1.8L 4 CIL	97/05

AMERICANA

AUDI 200 ANZ 1.8	96/99
------------------	-------

No. Original: 058-121-133-B



133-F-1

JETTA, BORA, BEETLE 2.5L	06/10
--------------------------	-------

No. Original: 07K-121-133-E



133-G

NACIONAL

GOLF A4	98/05
AUDI A3	96/01
AUDI TT 1.8L, 4 CIL	98/UP

AMERICANA

NEW BEETLE AEG, AZPK, AZG, AZJ, AQY 2.0L	98/06
NEW BEETLE CABRIO AZJ, BEV 2.0L, 4 CIL	03/06

No. Original: 06A-121-133-C, 06A-121-132-A

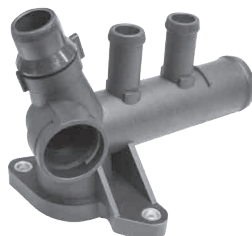

133-I

NACIONAL

SHARAN 1.8L, 4 CIL	02/07
--------------------	-------

No. Original: 06A-121-133-5



133-H

NACIONAL

JETTA A4 TURBO 1.8L, 4 CIL	03/UP
----------------------------	-------

No. Original: 06A-121-133-BC



133-J

NACIONAL

PASSAT, AUDI 1.6L, 4 CIL	00/UP
--------------------------	-------

No. Original: 06D-121-133-C



133-K

NACIONAL

JETTA 2.0L, 4 CIL	11/14
-------------------	-------

No. Original: 06A-121-133-AC



133-M

NACIONAL Y AMERICANA

CARIBE A1	79/86
COMBIT2	79/92
GOLF 1600 1.6L, 4 CIL	88/90

No. Original: 068-121-133-M



143-D

NACIONAL Y AMERICANA

EUROVAN T4 2.4 y 2.5L	93/97
MOTOR AAB, ACU y AAN 4 CIL y 5 CIL	

No. Original: 074-121-143-D



144

NACIONAL Y AMERICANA

GOLF, JETTA A2, A3 FBU C/AIRE	95/UP
DERBY y POINTER 1.7 y 1.8L, 4 CIL (CABEZA CON 1BULBO, 1 SALIDA)	

No. Original: 068-121-144



144-B

NACIONAL Y AMERICANA

A2-A3 1.8L, 4 CIL (LATERAL, 2 SALIDAS)	87/99
--	-------

No. Original: 026-121-144-B



144-C

NACIONAL

BORA	04/06
GOLF JETTA A4	99/06
EUROVAN PANEL	00/06

AMERICANA

AAC, ABL 4 Y 5 CIL	03/04
BORA TDI 1.9, GOLF R32 AUTOM.	01/05
ASZ	
JETTA VARIANT AUTO ASZ y MOTO 1.9	

No. Original: 044-121-144-B



144-H

NACIONAL

A3	93/99
DERBY 4 CIL.2.0L TRANS. MANUAL (2 BULBOS, 2 SALIDAS)	93/98

AMERICANA

DERBY 2.0L, 4 CIL	93/98
CABRIO	95/02
GOLF	93/02
JETTA	93/00

No. Original: 037-121-144-H



144-J

NACIONAL Y AMERICANA

FRONTAL GOLF, JETTA 2.0 L C/AIRE	93/99
CABRIO	95/02
(2 BULBOS, 3 SALIDAS)	

No. Original: 037-121-144-J



TOMAS DE AGUA

VOLKSWAGEN

TOMAS DE AGUA



145

**NACIONAL Y AMERICANA
(ALUMINIO)**

GOLF, JETTA 1800 4 CIL	88/UP
POINTER (CABEZA SIN BULBO) 1.8L, 4 CIL	94/08

No. Original: 026-121-145-E



145-2A

**NACIONAL Y AMERICANA
(ALUMINIO)**

POINTER (CABEZA CON BULBO) 1.8L, 4 CIL	94/08
---	-------

No. Original: 026-121-145-2



145-A

NACIONAL

GOLF, JETTA 1800 4 CIL CARIBE Y ATLANTIC C/AIRE	88/UP 75/86
--	----------------

AMERICANA

GOLF, JETTA A2, A3 1.8L	84/93
-------------------------	-------

No. Original: 026-121-145-F



145-B

NACIONAL

PASSAT (3B6)	00/05
AUDI 80	90/91
AUDI 80 (8C, B4) 4 CIL	91/94

AMERICANA

AUDI, CABRIO 2.0 A6, ABK	92/00
--------------------------	-------

No. Original: 048-121-145-B



145-C

NACIONAL

BORA	98/05
GOLF III	93/99
POLO	95/01
AUDI A3	96/01
SEAT CORDOBA, IBIZA	96/02
LEON Y TOLEDO 2.0L, 6 CIL	99/02

No. Original: 028-121-145-B



145-D

NACIONAL

EUROVAN PASAJEROS MOTOR AVT 2.5L, 5 CIL y CARGO 2.5L, 4 CIL	00/04 05/09
---	----------------

No. Original: 074-121-145-B

TOMAS DE AGUA

VOLKSWAGEN



TOMAS DE AGUA



145-P

**NACIONAL
(PLÁSTICO)**

GOLF, JETTA 1800 4 CIL

88/UP

AMERICANA

GOLF, JETTA A2, A3 1.8L, 4 CIL

84/93

No. Original: 026-121-145-E



291

MANGUERA FILTRO DE AIRE

NACIONAL Y AMERICANA

NEW BEETLE y A4 4 CIL
MOTOR BMP 2.0L

04/07

No. Original: 1J0-122-291



291-AE

NACIONAL Y AMERICANA

GOLF, NEW BEETLE, PASSAT,
BORA 2.5L
JETTA, AUDI A3 1.8L, 4 CIL
SEAT TOLEDO y LEÓN
(1 BULBO, 1 SALIDA)

99/UP

No. Original: 1K0-122-291-AE



291-B

**NACIONAL Y AMERICANA
COPE (INCLUYE SEGURO)**

A4 NEW BEETLE 2.5L, 6 CIL
SEAT TOLEDO y LEÓN

99/UP

99/UP

No. Original: 1J0-122-291-B



291-C

NACIONAL

COPE DE CALEFACCIÓN RECTO

JETTA A4 2.0L, 4 CIL

00/06

No. Original: 3B0-122-291-B



291-D

**NACIONAL Y AMERICANA
COPE (CON SEGURO)**

A4, NEW BEETLE, SHARAN
1.8L, 4 CIL TURBO

99/UP

No. Original: 1J0-122-291-D



291-E

NACIONAL

MANGUERA INFERIOR DEL RADIADOR

BORA 2.5L, 6 CIL

02/UP

No. Original: 6Q0-122-291-E



291-F

NACIONAL

COPE

A4 1.8L, 4 CIL
NEW BEETLE
(MANGUERA INFERIOR RADIADOR)

99/UP

No. Original: 6Q0-122-291-F



TOMAS DE AGUA

VOLKSWAGEN

TOMAS DE AGUA



291-G

NACIONAL

POLO MOTOR BBX 2.0L, 4 CIL 04/07

No. Original: 1J0-122-291-F



291-H

NACIONAL

BORA 2.0L, 4CIL TODOS

No. Original: 1K0-122-291-A



291-I

NACIONAL

NEW BEETLE 1.4L, 4 CIL	02/09
TOURAN 1.6L, 4 CIL	03/08
PASSAT 1.6L, 4 CIL	06/10
NEW BEETLE CABRIO 1.6L, 4 CIL	03/10

No. Original: 1C0-122-291-A



291-J

NACIONAL

COPLE DE CALEFACCIÓN

AUDI A3 2.0L, 4CIL	06/12
AUDI A3 3.2L, 6CIL	05/07
AUDI A3 3.2L, 6CIL	09/12
AUDI TT 1.8L, 4CIL	11/12
AUDI TT 2.0L, 4CIL	07/12
BORA 2.5L, 5CIL	05/10
EOS 2.0L, 4CIL	2010
GOLF 2.5L, 5CIL	10/13
GTI 2.0L, 4CIL	06/09
JETTA 1.8L, 4CIL	2008
JETTA NUEVA GENERACIÓN 2.5L, 5CIL	11/13
PASSAT 2.0L, 4CIL	06/08
PASSAT 2.0L, 4CIL	12/14
TIGUAN 1.4L, 4CIL	08/11
TIGUAN 2.0L, 4CIL	08/12

No. Original: 1K0-122-291-C



291-R

NACIONAL

COPLE DE CALEFACCIÓN

BORA 2.5L, 5 CIL 05/09

No. Original: 1K0-122-291-R

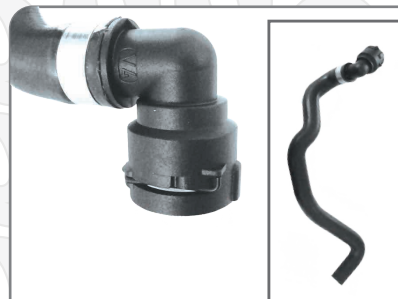

373-F

NACIONAL

COPLE DE CALEFACCIÓN CON MANGUERA

PASSAT 2.8L, 6 CIL 02/04

No. Original: 8D0-819-373-AF

NUEVO



438

VANAGON T25 1900, 2100 CC 86/87

No. Original: 251-121-438



438-A

NACIONAL

CORDO DE AGUA

POLO, SEAT E IBIZA 2.0L, 4 CIL 03/06

No. Original: 6Q0-121-438-A



NUEVO



438-AM

VANAGON T25 1900CC &
2100 CC

79/92

No. Original: 025-121-438-AM

NUEVO

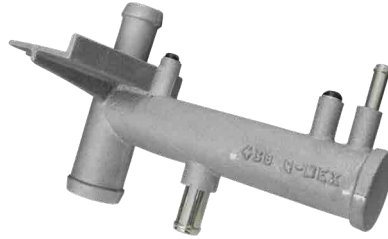

438-B

VANAGON T25
1900CC & 2100CC

86/92

No. Original: 111-450-490-0



438-C

NACIONAL

CODO DE AGUA

NEW BEETLE TURBO 1.8L, 4 CIL

00/05

No. Original: 1C0-121-438-A



619

NACIONAL

GOLF JETTA A3,
GOLF A4 CABRIOLET,
POLO 4 CIL

93/98

99/06

03/06

AMERICANA

DERBY ADD, ADC, ABA, 1.8
GOLF 1.8
GOLF CABRIO ADC, ABA 2.0
JETTA 1.8

95/97

93/99

96/02

93/99

No. Original: 037-121-619



186434

COPLER UNIVERSAL CON ENTRADA
PARA SENSOR

TODOS

No. Original:



1087-LG

NACIONAL

REPARTIDOR DE AGUA

BORA 2.5L, 6 CIL

02/UP

No. Original: 1K0-121-087-LG



TRACCIÓN

ESPIGAS Y JUNTAS HOMOCINÉTICAS

TOMAS DE AGUA



- 1. Juntas Homocinéticas LADO CAJA
- 1.1 Juntas Homocinéticas LADO RUEDA
- 2. Macheta tipo 1
- 2.1 Macheta tipo2
- 2.2 Macheta tipo3
- 3. Abrazaderas sin fin
- 4. Seguro
- 5. Grasa
- 6. Tuercas de flecha



PRECIO BAJO



CV-025

-ESPIGA-

FORD

MONDEO 4 CIL

00/05

LADO: RUEDA **TRICETA:** N/A
ESTRIADOS: EN VÁSTAGO 23, INTERIOR 27
TRANSMISIÓN: STANDARD/ AUTOMÁTICA
POSICIÓN: DERECHO/ IZQUIERDO

PRECIO BAJO



CV-029

-JUNTA HOMOCINÉTICA-

Ref R: RC-7029

Ref G: 325407

GENERAL MOTORS

ASTRA, MERIVA, ZAFIRA

00/04

LADO: CAJA **TRICETA:** N/A
ESTRIADOS: EN VÁSTAGO 34, INTERIOR 25
TRANSMISIÓN: AUTOMÁTICA
POSICIÓN: DERECHO/ IZQUIERDO

PRECIO BAJO



CV-051

-JUNTA HOMOCINÉTICA-

GENERAL MOTORS

CORSA, TORNADO

LADO: CAJA **TRICETA:** N/A
ESTRIADOS: EN VÁSTAGO 23, INTERIOR 22
TRANSMISIÓN: STANDARD/ AUTOMÁTICA
POSICIÓN: DERECHO/ IZQUIERDO

PRECIO BAJO



CV-124

-ESPIGA-

TOYOTA

SIENNA C/ABS

02/08

LADO: RUEDA **TRICETA:** N/A
ESTRIADOS: EN VÁSTAGO 27, INTERIOR 30
TRANSMISIÓN: STANDARD/ AUTOMÁTICA
POSICIÓN: DERECHO/ IZQUIERDO

PRECIO BAJO



CV-165

-ESPIGA-

GENERAL MOTORS

TORRENT, EQUINOX

06/13

LADO: RUEDA **TRICETA:** N/A
ESTRIADOS: EN VÁSTAGO 24, INTERIOR 30
TRANSMISIÓN: STANDARD/ AUTOMÁTICA
POSICIÓN: DERECHO/ IZQUIERDO

PRECIO BAJO



CV-199

-ESPIGA-

Ref R: 10222199

DODGE, CHRYSLER

JOURNEY

06/14

LADO: RUEDA **TRICETA:** N/A
ESTRIADOS: EN VÁSTAGO 32, INTERIOR 32
TRANSMISIÓN: AUTOMÁTICA
POSICIÓN: DERECHO/ IZQUIERDO



TRACCIÓN

ESPIGAS Y JUNTAS HOMOCINÉTICAS

JUNTAS HOMOCINÉTICAS



CV-203

-ESPIGA-
 Ref R: RR-9406
 Ref G: 325407
 NISSAN

TSURU I	84/87
---------	-------

LADO: RUEDA **TRICETA:** N/A
ESTRIADOS: EN VÁSTAGO 24, INTERIOR 22
TRANSMISIÓN: STANDARD/ AUTOMÁTICA
POSICIÓN: DERECHO/ IZQUIERDO



CV-206

-ESPIGA-
 Ref R: RR-9401
 Ref G: 325416
 VOLKSWAGEN

CARIBE, ATLANTIC (SIN SEGURO)	80/87
CORSAR	85/87
GOLF GL & GT	85/92
JETTA GL & GT	80/92
RABBIT (PICK UP)	80/87
DERBY (CASCO CHICO/ SIN SEGURO)	95/08
POINTER (SIN SEGURO)	97/09
POINTER PICK UP	97/10

LADO: RUEDA **TRICETA:** N/A
ESTRIADOS: EN VÁSTAGO 22, INTERIOR 30
TRANSMISIÓN: STANDARD/ AUTOMÁTICA
POSICIÓN: DERECHO/ IZQUIERDO



CV-207

-JUNTA HOMOCINÉTICA-
 Ref R: RC-8207
 Ref: CTK8207
 GENERAL MOTORS

SPARK (1.4L)	11/14
--------------	-------

LADO: CAJA **TRICETA:** N/A
ESTRIADOS: EN VÁSTAGO 22, INTERIOR 19
TRANSMISIÓN: STANDARD
POSICIÓN: IZQUIERDO



CV-212

-ESPIGA-
 Ref : CV-506
 Ref G: 2748038
 GMC

ACADIA, TRAVERSE, ENCLAVE	07/17
---------------------------	-------

LADO: RUEDA **TRICETA:** N/A
ESTRIADOS: EN VÁSTAGO 33, INTERIOR 36
TRANSMISIÓN: STANDARD/ AUTOMÁTICA
POSICIÓN: DERECHO/ IZQUIERDO



CV-215

-ESPIGA-
 Ref R: RR-9403
 Ref G: 325712
 NISSAN

HIKARI	88/91
VERNA	03/09
TSURU II	88/91

LADO: RUEDA **TRICETA:** N/A
ESTRIADOS: EN VÁSTAGO 25, INTERIOR 24
TRANSMISIÓN: STANDARD/ AUTOMÁTICA
POSICIÓN: DERECHO/ IZQUIERDO



CV-216

-ESPIGA-
 Ref R: RR-9412
 Ref G: 325990
 VOLKSWAGEN

POINTER	98/08
CORSAR	84/89

LADO: RUEDA **TRICETA:** N/A
ESTRIADOS: EN VÁSTAGO 22, INTERIOR 30
TRANSMISIÓN: STANDARD/ AUTOMÁTICA
POSICIÓN: DERECHO/ IZQUIERDO



PRECIO BAJO



CV-222

-ESPIGA-

Ref R: RR-9404
Ref G: 326300
CHRYSLER

NEW YORKER, PHANTOM, LEBARON SPIRIT, SHADOW, VOYAGER PLYMOUTH, ACLAIM, SUNDANCE	89/95
---	-------

LADO: RUEDA **TRICETA:** T-32715A
ESTRIADOS: EN VÁSTAGO 26, INTERIOR 32
TRANSMISIÓN: STANDARD/ AUTOMÁTICA
POSICIÓN: DERECHO/ IZQUIERDO



CV-223

-ESPIGA-

Ref R: RR-9416
Ref G: 326542
GENERAL MOTORS

CELEBRITY	91/93
CENTURY	91/93
CUTLASS, CUTLASS EUROSPORT	91/93

LADO: RUEDA **TRICETA:** N/A
ESTRIADOS: EN VÁSTAGO 27, INTERIOR 32
TRANSMISIÓN: STANDARD/ AUTOMÁTICA
POSICIÓN: DERECHO/ IZQUIERDO

PRECIO BAJO



CV-225

-ESPIGA-

Ref R: RR-9400
Ref G: 326582
NISSAN

TSURU III	92/08
TSUBAME	93/04

LADO: RUEDA **TRICETA:** T-24211
ESTRIADOS: EN VÁSTAGO 25, INTERIOR 24
TRANSMISIÓN: STANDARD/ AUTOMÁTICA
POSICIÓN: DERECHO/ IZQUIERDO

PRECIO BAJO



CV-226

-ESPIGA-

Ref R: RR-9402
Ref G: 325416
VOLKSWAGEN

JETTA 1.8 y 2.0L	92/98
GOLF, JETTA	85/99
DERBY (CASCO GRANDE 90 mm)	94/09
CROSS FOX	07/17
LUPO	05/09
PASSAT	89/96
POLO	03/07
SPORT VAN	03/07
ATLANTIC	80/87
CARIBE	80/87
POINTER	97/09

LADO: RUEDA **TRICETA:** N/A
ESTRIADOS: EN VÁSTAGO 22, INTERIOR 30
TRANSMISIÓN: STANDARD/ AUTOMÁTICA
POSICIÓN: DERECHO/ IZQUIERDO

PRECIO BAJO



CV-232

-ESPIGA-

Ref R: RR-9413
Ref G: 326935
GENERAL MOTORS (S/ABS)

CHEVY, CHEVY MONZA, JOY, SWING, POP	94/12
CHEVY PICK UP	99/03

LADO: RUEDA **TRICETA:** T-28211
ESTRIADOS: EN VÁSTAGO 22, INTERIOR 28
TRANSMISIÓN: STANDARD
POSICIÓN: DERECHO/ IZQUIERDO



TRACCIÓN

ESPIGAS Y JUNTAS HOMOCINÉTICAS

JUNTAS HOMOCINÉTICAS

PRECIO BAJO



CV-236

-ESPIGA-

Ref G: 326763
GENERAL MOTORS

CENTURY, CELEBRITY, CUTLASS, CUTLASS CIERA, CUTLASS EUROSPORT	94/96
---	-------

LADO: RUEDA **TRICETA:** N/A
ESTRIADOS: EN VÁSTAGO 33, INTERIOR 32
TRANSMISIÓN: STANDARD/ AUTOMÁTICA
POSICIÓN: DERECHO/ IZQUIERDO



CV-237-A

-ESPIGA-

Ref R: RR-9409
Ref G: 326764
GENERAL MOTORS

CHEVROLET: BERETTA, CORSCA	87/96
CAVALIER, CAVALIER Z24	90/05
CENTURY CUTLASS	87/90
GRAND AM	85/98
SUNFIRE	95/05

LADO: RUEDA **TRICETA:** N/A
ESTRIADOS: EN VÁSTAGO 32, INTERIOR 32
TRANSMISIÓN: STANDARD/ AUTOMÁTICA
POSICIÓN: DERECHO/ IZQUIERDO

PRECIO BAJO



CV-240

-ESPIGA-

Ref R: RR-9410
Ref G: 326905
NISSAN

LUCCINO HF (S/ABS)	96/01
SENTRA	96/06
TSUBAME	92/14
TSURU III	00/04

LADO: RUEDA **TRICETA:** N/A
ESTRIADOS: EN VÁSTAGO 25, INTERIOR 32
TRANSMISIÓN: STANDARD/ AUTOMÁTICA
POSICIÓN: DERECHO/ IZQUIERDO

PRECIO BAJO



CV-242

-ESPIGA-

Ref R: RR-9023
Ref G: 328119
FORD

ECOSPORT	03/12
FOCUS	99/06

LADO: RUEDA **TRICETA:** N/A
ESTRIADOS: EN VÁSTAGO 25, INTERIOR 23
TRANSMISIÓN: STANDARD/ AUTOMÁTICA
POSICIÓN: DERECHO/ IZQUIERDO

PRECIO BAJO



CV-243

-ESPIGA-

VOLSWAGEN

BEETLE 1.8L y 2.1L	98/11
JETTA, GOLF A4 2.0L (90 mm)	99/06
JETTA, JETTA IV	98/15
GOLF A4	99/09
GOLF IV	98/07

LADO: RUEDA **TRICETA:** T-30035,
T-34040
ESTRIADOS: EN VÁSTAGO 36, INTERIOR 30
TRANSMISIÓN: STANDARD/ AUTOMÁTICA
POSICIÓN: DERECHO/ IZQUIERDO

PRECIO BAJO



CV-245

-ESPIGA-

Ref R: RR-8122
Ref G: 328122
NISSAN

PLATINA (S/ABS), CLIO	02/09
PLATINA FLECHA FRANCESA, CLIO	02/09
KANGOO	02/18

LADO: RUEDA **TRICETA:** T-21815A
T-30211A
ESTRIADOS: EN VÁSTAGO 21, INTERIOR 21
TRANSMISIÓN: STANDARD
POSICIÓN: DERECHO/ IZQUIERDO



PRECIO BAJO

CV-248

-ESPIGA-
 Ref R: RR-9007, RR-9414
 Ref G: 327752
 FORD

FIESTA, IKON, COURIER KA	98/11 01/05
-----------------------------	----------------

LADO: RUEDA **TRICETA:** T-21815A
ESTRIADOS: EN VÁSTAGO 25, INTERIOR 21
TRANSMISIÓN: STANDARD
POSICIÓN: DERECHO/ IZQUIERDO



PRECIO BAJO

CV-250

-ESPIGA-
 Ref R: RR-7542
 Ref G: 327542
 CHRYSLER

NEON PT CRUISER (C/ABS)	00/07 00/10
----------------------------	----------------

LADO: RUEDA **TRICETA:** N/A
ESTRIADOS: EN VÁSTAGO 26, INTERIOR 23
TRANSMISIÓN: STANDARD/ AUTOMÁTICA
POSICIÓN: DERECHO/IZQUIERDO



CV-251

-ESPIGA-
 Ref R: RR-8124
 Ref G: 328124
 NISSAN/ RENAULT

PLATINA CLIO (FRENOS ABS) KANGOO	02/10 02/10 04/10
---	-------------------------

LADO: RUEDA **TRICETA:** N/A
ESTRIADOS: EN VÁSTAGO 21, INTERIOR 21
TRANSMISIÓN: STANDARD/ AUTOMÁTICA
POSICIÓN: DERECHO/IZQUIERDO



PRECIO BAJO

CV-253

-ESPIGA-
 Ref R: RR-9021
 Ref G: 328193
 FORD

WINDSTAR 3.8L (C/ABS)	95/03
--------------------------	-------

LADO: RUEDA **TRICETA:** N/A
ESTRIADOS: EN VÁSTAGO 26, INTERIOR 32
TRANSMISIÓN: AUTOMÁTICA
POSICIÓN: DERECHO/IZQUIERDO



CV-254

-ESPIGA-
 Ref R: RR-9004
 Ref G: 2748008
 GENERAL MOTORS

LUMINA APV VENTURE SILHOUETTE MONTANA TRANSPORT BONEVILLE CENTURY REGAL, GRAND PRIX, IMPALA 3.8L MONTECARLO IMPALA	90/96 97/06 90/04 99/07 90/98 92/01 94/99 97/00 00 00/11
---	---

LADO: RUEDA **TRICETA:** N/A
ESTRIADOS: EN VÁSTAGO 33, INTERIOR 32
TRANSMISIÓN: AUTOMÁTICA
POSICIÓN: DERECHO/IZQUIERDO



CV-259

-ESPIGA-
 Ref R: RR-9242
 GENERAL MOTORS

BLAZER K1500 4X4 K3500 SUBURBAN K1500 4X4 PICK UP K2500 4X4 7200 PICK UP K2500 4X4 8600 PICK UP K3500 4X4 PICK UP SUBURBAN K1500 4X4 SUBURBAN K2500 4X4	88/94 88/94 88/94 88/94 88/94 88/94 88/94 88/94
--	--

LADO: RUEDA **TRICETA:** N/A
ESTRIADOS: EN VÁSTAGO 33, INTERIOR 35
TRANSMISIÓN: AUTOMÁTICA
POSICIÓN: DERECHO/IZQUIERDO



TRACCIÓN

ESPIGAS Y JUNTAS HOMOCINÉTICAS

JUNTAS HOMOCINÉTICAS

PRECIO BAJO



CV-260

-ESPIGA-

GENERAL MOTORS

ASTRO, MINIVAN, 4X4	90/05
C-1500, C-2500, SUBURBAN 1500, SUBURBAN, 4X4	88/95
PICK UP K1500 4X4 C/ABS	88/94

LADO: RUEDA **TRICETA:** N/A
ESTRIADOS: EN VÁSTAGO 33, INTERIOR 35
TRANSMISIÓN: STANDARD/ AUTOMÁTICA
POSICIÓN: DERECHO/IZQUIERDO



CV-264

-ESPIGA-

Ref. R: RR-9274

Ref. G: CV-405

AUDI/VW

A4 (2.8 LTS AUT)	98/01
A6 (2.8 LTS AUT)	98/01
PASSAT (2.8 LTS) C/ABS	97/03

LADO: RUEDA **TRICETA:** N/A
ESTRIADOS: EN VÁSTAGO 38, INTERIOR 27
TRANSMISIÓN: STANDARD/ AUTOMÁTICA
POSICIÓN: DERECHO/IZQUIERDO

PRECIO BAJO



CV-272

-ESPIGA-

Ref. R: RR-9418

Ref. G: 328188

CHRYSLER

VOYAGER C/ABS	96/08
CARAVAN, GRAND CARAVAN	
GRAND VOYAGER,	
TOWN & COUNTRY C/ABS	

LADO: RUEDA **TRICETA:** T-32715A1
ESTRIADOS: EN VÁSTAGO 26, INTERIOR 32
TRANSMISIÓN: AUTOMÁTICA
POSICIÓN: DERECHO/IZQUIERDO

PRECIO BAJO



CV-276

-JUNTA HOMOCINÉTICA-

Ref. R: RC-5526

Ref. G: 325526

FORD/SEAT/VW

LADO: CAJA **TRICETA:** N/A
ESTRIADOS: INTERIOR 33
TRANSMISIÓN: STANDARD/ AUTOMÁTICA
POSICIÓN: DERECHO/IZQUIERDO

MERCURY, AERO STAR 4X4	86/97
CORDOBA, IBIZA	01/02
ATLANTIC, CARIBE	77/87
CORSAR	84/89
DERBY	95/09
GOLF II	85/92
JETTA A1 y A2	80/92
POINTER	97/08
POINTER PICK UP	97/10
RABBIT	75/84
QUANTUM	82/87
SCIROCCO	74/89

PRECIO BAJO



CV-279

-ESPIGA-

Ref. R: RR-9019

Ref. G: 324995

FORD

ESCORT - ZX2 1.9L S/ABS	91/02
-------------------------	-------

LADO: RUEDA **TRICETA:** N/A
ESTRIADOS: EN VÁSTAGO 26, INTERIOR 28
TRANSMISIÓN: STANDARD/ AUTOMÁTICA
POSICIÓN: DERECHO/IZQUIERDO



PRECIO BAJO



CV-287

-ESPIGA-

Ref. R: RR-9270
Ref. G: 5048002
HONDA

CIVIC, CRX (C/ABS)	92/00
--------------------	-------

LADO: RUEDA **TRICETA:** N/A
ESTRIADOS: EN VÁSTAGO 26, INTERIOR 30
TRANSMISIÓN: AUTOMÁTICA
POSICIÓN: DERECHO/IZQUIERDO



CV-297

-ESPIGA-

Ref. R: RR-9229
FORD/NISSAN

VILLAGER QUEST (FRENOS ABS)	93/02 93/08
-----------------------------------	----------------

LADO: RUEDA **TRICETA:** N/A
ESTRIADOS: EN VÁSTAGO 32, INTERIOR 34
TRANSMISIÓN: AUTOMÁTICA
POSICIÓN: DERECHO/IZQUIERDO



CV-300

-ESPIGA-

Ref. R: RR-9227
Ref. G: 326292
NISSAN

ALTIMA (C/ABS)	93/01
----------------	-------

LADO: RUEDA **TRICETA:** N/A
ESTRIADOS: EN VÁSTAGO 27, INTERIOR 26
TRANSMISIÓN: AUTOMÁTICA
POSICIÓN: DERECHO/IZQUIERDO



CV-303

-JUNTA HOMOCINÉTICA-

Ref. R: RC-6334
Ref. G: 326334
DODGE, CHRYSLER

LEBARON	89/95
NEW YORKER	89/95
PHANTOM	89/95
SHADOW	89/95
SPIRIT	89/95
ACCLAIM	89/95
SUNDANCE	89/95

LADO: CAJA **TRICETA:** N/A
ESTRIADOS: EN VÁSTAGO 25, INTERIOR 25
TRANSMISIÓN: AUTOMÁTICA
POSICIÓN: DERECHO/IZQUIERDO



CV-314

-JUNTA HOMOCINÉTICA-

REF.: RC-6591
VOLKSWAGEN

CORDOBA	03/09
IBIZA	03/18
LEON	01/13
TOLEDO	01/18
GOLF Y JETTA A4	98/15
VENTO	14/17
CROSS FOX	07/10
BEETLE 1.8 L	98/11

LADO: CAJA **TRICETA:** N/A
ESTRIADOS: EXT: N/A INT: 33
TRANSMISIÓN: STANDARD/ AUTOMÁTICA
POSICIÓN: DERECHO



CV-322

-ESPIGA-

Ref. G: 4048001
FORD

KA	01/08
----	-------

LADO: RUEDA **TRICETA:** N/A
ESTRIADOS: EN VÁSTAGO 25, INTERIOR 20
TRANSMISIÓN: STANDARD
POSICIÓN: DERECHO/IZQUIERDO



TRACCIÓN

ESPIGAS Y JUNTAS HOMOCINÉTICAS

JUNTAS HOMOCINÉTICAS

PRECIO BAJO



CV-324

-ESPIGA-

Ref. R: RR-2289
Ref. G: 5048004, 10222289
HONDA

CIVIC CRX	06/11 06/09
--------------	----------------

LADO: RUEDA **TRICETA:** N/A
ESTRIADOS: EN VÁSTAGO 26, INTERIOR 22
TRANSMISIÓN: AUTOMÁTICA
POSICIÓN: DERECHO/IZQUIERDO

PRECIO BAJO



CV-325

-ESPIGA-

CHRYSLER

ODYSSEY	05/10
---------	-------

LADO: RUEDA **TRICETA:** N/A
ESTRIADOS: EN VÁSTAGO 35, INTERIOR 30
TRANSMISIÓN: STANDARD/ AUTOMÁTICA
POSICIÓN: DERECHO/IZQUIERDO

PRECIO BAJO



CV-327

-ESPIGA-

Ref. G: 5048014
HONDA

CIVIC (C/ABS)	01/05
---------------	-------

LADO: RUEDA **TRICETA:** N/A
ESTRIADOS: EN VÁSTAGO 23, INTERIOR 26
TRANSMISIÓN: STANDARD/ AUTOMÁTICA
POSICIÓN: DERECHO/IZQUIERDO

PRECIO BAJO



CV-328

-ESPIGA-

AUDI/ SEAT

AUDI A1 CORDOBA IBIZA	11/17 03/09 03/08
-----------------------------	-------------------------

LADO: RUEDA **TRICETA:** N/A
ESTRIADOS: EN VÁSTAGO 36, INTERIOR 30
TRANSMISIÓN: STANDARD/ AUTOMÁTICA
POSICIÓN: DERECHO/IZQUIERDO

PRECIO BAJO



CV-330

-ESPIGA-

Ref R: RR-9033
Ref G: 10221452
VOLKSWAGEN

AUDI A3 TFSI	04/12
ALTEA, LEON, TOLEDO TFSI	06/15
BORA TFSI 2.0L y 2.5L	05/10
PASSAT	05/10
PASSAT CC	08/15
TIGUAN	09/17

LADO: RUEDA **TRICETA:** N/A
ESTRIADOS: EXT: 36 INT: 27
TRANSMISIÓN: MANUAL Y AUTOMÁTICA
POSICIÓN: DERECHO/IZQUIERDO

PRECIO BAJO



CV-331

-JUNTA HOMOCINÉTICA-

TOYOTA

TACOMA 4X4	95/04
------------	-------

LADO: CAJA **TRICETA:** N/A
ESTRIADOS:
TRANSMISIÓN: MANUAL Y AUTOMÁTICA
POSICIÓN: DERECHO/IZQUIERDO



CV-337

-ESPIGA-

Ref R: RR-9017
Ref G: 6748026
AUDI/ SEAT

MAXIMA	95/03
X-TRAIL 2.5L (C/ABS)	01/13

LADO: RUEDA **TRICETA:** N/A
ESTRIADOS: EN VÁSTAGO 29, INTERIOR 25
TRANSMISIÓN: AUTOMÁTICA
POSICIÓN: DERECHO/IZQUIERDO



CV-342

-ESPIGA-

CHRYSLER/ JEEP/ MITSUBISHI

CALIBER	07/12
PATRIOT, COMPAS	07/15
LANCER	08/14

LADO: RUEDA **TRICETA:** N/A
ESTRIADOS: EN VÁSTAGO 28, INTERIOR 33
TRANSMISIÓN: STANDARD/ AUTOMÁTICA
POSICIÓN: DERECHO/IZQUIERDO



CV-346

-JUNTA HOMOCINÉTICA-
AUDI/ VOLKSWAGEN

A3 2.0L FSI	04/12
ALTEA 2.0L FSI	06/15
LEON 2.0L FSI	06/13
BORA	04/12

LADO: CAJA **TRICETA:** N/A
ESTRIADOS: EN VÁSTAGO 26, INTERIOR 32
TRANSMISIÓN: AUTOMÁTICA
POSICIÓN: DERECHO/IZQUIERDO



CV-348

-ESPIGA-

Ref R: RR-9016
VOLKSWAGEN

CROSSFOX	07/17
POLO 1.6L	03/09
LUPO 1.6L	03/09
SPORT VAN	03/08

LADO: RUEDA **TRICETA:** N/A
ESTRIADOS: EN VÁSTAGO 36, INTERIOR 30
TRANSMISIÓN: STANDARD/ AUTOMÁTICA
POSICIÓN: DERECHO/IZQUIERDO



CV-349

-ESPIGA-

Ref R: RR-9323
AUDI/ SEAT/ VW

A4(2.0 LTS)	08/15
ALTEA (1.4 TFSI)	06/15
LEON (1.4 TFSI)	06/13
TOLEDO (1.4 TFSI)	06/12
BORA (2.0 LTS)	06/12
VI (1.4 TFSI)	10/12

LADO: RUEDA **TRICETA:** N/A
ESTRIADOS: EN VÁSTAGO 36, INTERIOR 30
TRANSMISIÓN: STANDARD
POSICIÓN: DERECHO/IZQUIERDO



CV-350

-ESPIGA-

Ref R: RR-9027
Ref G: 3048022
HYUNDAI

VERNA (C/ABS)	03/09
---------------	-------

LADO: RUEDA **TRICETA:** N/A
ESTRIADOS: EN VÁSTAGO 25, INTERIOR 22
TRANSMISIÓN: STANDARD/ AUTOMÁTICA
POSICIÓN: DERECHO/IZQUIERDO



TRACCIÓN

ESPIGAS Y JUNTAS HOMOCINÉTICAS

JUNTAS HOMOCINÉTICAS



PRECIO BAJO

CV-351

-ESPIGA-
 Ref R: RR-9034
 Ref G: 3048020
 CHRYSLER/HYUNDAI

ATTITUDE 1.4 y 1.6L	06/11
VERNA	04/06
ACCENT	06/10
RIO	06/11

LADO: RUEDA **TRICETA:** N/A
ESTRIADOS: EN VÁSTAGO 25, INTERIOR 22
TRANSMISIÓN: STANDARD/ AUTOMÁTICA
POSICIÓN: DERECHO/IZQUIERDO



PRECIO BAJO

CV-402

-ESPIGA-
 Ref.: RR-9000
 Ref G: 289-3459
 CHRYSLER

ATOS 1.0 L	00/04
------------	-------

LADO: RUEDA **TRICETA:** T-19182
ESTRIADOS: EN VÁSTAGO 25, INTERIOR 19
TRANSMISIÓN: STANDARD
POSICIÓN: DERECHO/IZQUIERDO



CV-410

-ESPIGA-
 Ref R: RR-9273
 Ref G: 4048005
 FORD

ESCORT - ZX2 (FRENOS ABS)	91/02
MERCURY y TRACER	94/99

LADO: RUEDA **TRICETA:** N/A
ESTRIADOS: EN VÁSTAGO 26, INTERIOR 28
TRANSMISIÓN: STANDARD/ AUTOMÁTICA
POSICIÓN: DERECHO/IZQUIERDO



PRECIO BAJO

CV-412

-ESPIGA-
 Ref R: RR-9217
 Ref G: 326975
 NISSAN

AMERICANOS LUCCINO, SENTRA	96/00
SENTRA 1.6L	90/96
200 SX	95/98

LADO: RUEDA **TRICETA:** N/A
ESTRIADOS: EN VÁSTAGO 25, INTERIOR 23
TRANSMISIÓN: STANDARD/ AUTOMÁTICA
POSICIÓN: DERECHO/IZQUIERDO



PRECIO BAJO

CV-414

-JUNTA HOMOCINÉTICA-
 Ref R: RC-7041
 Ref G: 27480
 PONTIAC

MATIZ	03/14
-------	-------

LADO: CAJA **TRICETA:** N/A
ESTRIADOS: EN VÁSTAGO 22, INTERIOR 19
TRANSMISIÓN: STANDARD
POSICIÓN: DERECHO/IZQUIERDO



PRECIO BAJO

CV-420

-ESPIGA-
 GENERAL MOTORS
 Ref R: RC-9030

CORSA	02/08
TORNADO	04/11
CHEVY MÉXICO	06/12
CHEVY BRASIL (SIN SEGURO)	98/03

LADO: RUEDA **TRICETA:** N/A
ESTRIADOS: EN VÁSTAGO 22, INTERIOR 22
TRANSMISIÓN: STANDARD
POSICIÓN: DERECHO/IZQUIERDO



CV-420-S	
-ESPIGA-	
Ref R: RR9030 GENERAL MOTORS	
CHEVY PICK UP (CON SEGURO)	TODOS
LADO: RUEDA TRICETA: N/A ESTRIADOS: EN VÁSTAGO 22, INTERIOR 22 TRANSMISIÓN: STANDARD POSICIÓN: DERECHO/IZQUIERDO	



CV-421	
-ESPIGA-	
Ref G: 327543 Ref R: RR9456 CHRYSLER	
NEON PT CRUISER (S/ABS)	00/07 00/09
LADO: RUEDA TRICETA: N/A ESTRIADOS: EN VÁSTAGO 26, INTERIOR 22 TRANSMISIÓN: STANDARD/ AUTOMÁTICA POSICIÓN: DERECHO/IZQUIERDO	



CV-423	
-ESPIGA-	
PONTIAC	
MATIZ	04/12
LADO: RUEDA TRICETA: N/A ESTRIADOS: EN VÁSTAGO 22, INTERIOR 19 TRANSMISIÓN: STANDARD POSICIÓN: DERECHO/IZQUIERDO	



CV-424	
-ESPIGA-	
Ref R: RR-9028 Ref G: 2748023 GENERAL MOTORS	
MATIZ 1.0L SPARK 1.2L (S/ABS)	04/12 11/15
LADO: RUEDA TRICETA: N/A ESTRIADOS: EN VÁSTAGO 23, INTERIOR 19 TRANSMISIÓN: STANDARD POSICIÓN: DERECHO/IZQUIERDO	



CV-425	
-ESPIGA-	
Ref R: RR-9426 Ref G: 328426 NISSAN	
TSURU III TSUBAME	03/17 03/08
LADO: RUEDA TRICETA: N/A ESTRIADOS: EN VÁSTAGO 25, INTERIOR 23 TRANSMISIÓN: STANDARD/ AUTOMÁTICA POSICIÓN: DERECHO/IZQUIERDO	



CV-438	
-JUNTA HOMOCINÉTICA-	
Ref R: RC-7020 CHRYSLER	
CARAVAN GRAND VOYAGER TOWN & COUNTRY VOYAGER CIRRUS STRATUS LEBARON	96/07 96/07 96/07 96/07 01/06 01/06 96/04
LADO: CAJA TRICETA: N/A ESTRIADOS: EN VÁSTAGO 25, INTERIOR 32 TRANSMISIÓN: AUTOMÁTICA POSICIÓN: DERECHO/IZQUIERDO	



TRACCIÓN

ESPIGAS Y JUNTAS HOMOCINÉTICAS

JUNTAS HOMOCINÉTICAS



CV-440

-ESPIGA-

FORD

FIESTA COURIER	00/12
FIESTA-IKON	98/11

LADO: RUEDA **TRICETA:** N/A
ESTRIADOS: EN VÁSTAGO 25, INTERIOR 22
TRANSMISIÓN:
POSICIÓN:



PRECIO BAJO

CV-441

-JUNTA HOMOCINÉTICA-

FORD

ESCORT	91/02
--------	-------

LADO: CAJA **TRICETA:** N/A
ESTRIADOS: EN VÁSTAGO 28, INTERIOR 24
TRANSMISIÓN: AUTOMÁTICA
POSICIÓN: IZQUIERDA



CV-442

-ESPIGA-

Ref. R: RR-9022

GENERAL MOTORS

BERETTA, CORSICA	92/96
CAVALIER - Z24	94/05
GRAND AM	97/98
SUNFIRE	95/05
SKYLARK	97/98
ACHIEVA	97
(FRENOS ABS)	

LADO: RUEDA **TRICETA:** N/A
ESTRIADOS: EN VÁSTAGO 33, INTERIOR 32
TRANSMISIÓN: STANDARD/ AUTOMÁTICA
POSICIÓN: DERECHO/IZQUIERDO



PRECIO BAJO

CV-447

-ESPIGA-

Ref. R: RR-9310

Ref. G: 4048008

FORD/ MAZDA

ESCAPE - MARINER	01/04
TRIBUTE	01/04
(FRENOS ABS)	

LADO: RUEDA **TRICETA:** N/A
ESTRIADOS: EN VÁSTAGO 28, INTERIOR 24
TRANSMISIÓN: AUTOMÁTICA
POSICIÓN: DERECHO/IZQUIERDO



PRECIO BAJO

CV-455

-JUNTA HOMOCINÉTICA-

Ref R: RC-7446

Ref G: 327446

VOLKSWAGEN

AUDI A6	98/01
NEW BETTLE 2.0L	98/11
NEW BETTLE TURBO 1.8 y 3.2L	99/05
GOLF 1.8 y 2.0L	98/07
JETTA A4 2.0L	98/15
JETTA CLASICO	10/14

LADO: CAJA **TRICETA:** N/A
ESTRIADOS: EN VÁSTAGO, INTERIOR 30
TRANSMISIÓN: STANDARD/ AUTOMÁTICA
POSICIÓN: DERECHO/IZQUIERDO



PRECIO BAJO

CV-457

-JUNTA HOMOCINÉTICA-

Ref R: RC-6931

Ref G: 326931

GENERAL MOTORS

CHEVY JOY, SWING	94/03
CHEVY MONZA	97/03
CHEVY PICK UP	99/03
CHEVY POP	96/03
CHEVY (MEX)	94/12

LADO: CAJA **TRICETA:** N/A
ESTRIADOS: EN VÁSTAGO 22, INTERIOR 28
TRANSMISIÓN: STANDARD
POSICIÓN: DERECHO/IZQUIERDO



CV-458

-ESPIGA-
GENERAL MOTORS

CHEVY (MEX)	06/12
CORSA	02/08
TORNADO (FRENOS ABS)	04/11

LADO: RUEDA **TRICETA:** N/A
ESTRIADOS: EN VÁSTAGO 22, INTERIOR 22
TRANSMISIÓN: STANDARD
POSICIÓN: DERECHO/IZQUIERDO



CV-464

-ESPIGA-
Ref R: RR-9029
Ref G: 3048006
CHRYSLER

ATOS 1.1L	05/12
-----------	-------

LADO: RUEDA **TRICETA:** N/A
ESTRIADOS: EN VÁSTAGO 25, INTERIOR 20
TRANSMISIÓN: STANDARD
POSICIÓN: DERECHO/IZQUIERDO



CV-611

-ESPIGA-
GENERAL MOTORS

CHEVY y MONZA 1.6L 4 CIL (PARA FRENOS ABS)	TODOS
---	-------

LADO: RUEDA **TRICETA:** N/A
ESTRIADOS: EN VÁSTAGO 22, INTERIOR 28
TRANSMISIÓN: STANDARD
POSICIÓN: DERECHO/IZQUIERDO



CV-614

-JUNTA HOMOCINÉTICA-
NISSAN

TIIDA 1.8LTS	06/15
--------------	-------

LADO: CAJA **TRICETA:** N/A
ESTRIADOS: EN VÁSTAGO 25, INTERIOR 23
TRANSMISIÓN: STANDARD/ AUTOMÁTICA
POSICIÓN: DERECHO



CV-708

-JUNTA HOMOCINÉTICA-
GENERAL MOTORS

TORNADO, CHEVY PICK UP CORSA	04/07 04/09
---------------------------------	----------------

LADO: CAJA **TRICETA:** N/A
ESTRIADOS: EN VÁSTAGO 22, INTERIOR 22
TRANSMISIÓN: STANDARD/ AUTOMÁTICA
POSICIÓN: DERECHO/IZQUIERDO



CV-715

-JUNTA HOMOCINÉTICA-
CHRYSLER

CARAVAN	96/07
GRAND VOYAGER	96/07
TOWN & COUNTRY	96/07
VOYAGER	96/07

LADO: CAJA **TRICETA:** N/A
ESTRIADOS: EN VÁSTAGO 25, INTERIOR 32
TRANSMISIÓN: STANDARD
POSICIÓN: DERECHO



TRACCIÓN

ESPIGAS Y JUNTAS HOMOCINÉTICAS

JUNTAS HOMOCINÉTICAS

PRECIO BAJO



CV-733

-JUNTA HOMOCINÉTICA-

VW/ AUDI

GOLF A4 GTI TURBO	02/05
JETTA A4	02/04
JETTA A4 TURBO	02/05
A4, S4	04/05
A6, A8	05

LADO: CAJA **TRICETA:** N/A
ESTRIADOS: EN VÁSTAGO 34, INTERIOR 33
TRANSMISIÓN: STANDARD/ AUTOMÁTICA
POSICIÓN:

PRECIO BAJO



CV-744

-ESPIGA-

Ref R: RR-9297

Ref G: 5048009

HONDA

CR-V 2.4L	02/06
-----------	-------

LADO: RUEDA **TRICETA:** N/A
ESTRIADOS: EN VÁSTAGO 32, INTERIOR 28
TRANSMISIÓN: AUTOMÁTICA
POSICIÓN: DERECHO/IZQUIERDO

PRECIO BAJO



CV-777

-ESPIGA-

Ref R: RR-9295

Ref G: 4048016

FORD

FREESTAR MONTERREY 4.2L	03/07
-------------------------	-------

LADO: RUEDA **TRICETA:** N/A
ESTRIADOS: EN VÁSTAGO 26, INTERIOR 24
TRANSMISIÓN: AUTOMÁTICA
POSICIÓN: DERECHO/IZQUIERDO

PRECIO BAJO



CV-859

-JUNTA HOMOCINÉTICA-

Ref R: RC-7008

ACURA/ HONDA/ ISUZU

CL	97/99
ACCORD	90/00
CRV	98/01
PRELUDE	90/96
OASIS	96/98

LADO: CAJA **TRICETA:** N/A
ESTRIADOS: EN VÁSTAGO 27, INTERIOR 32
TRANSMISIÓN: STANDARD
POSICIÓN: IZQUIERDA

TRACCIÓN: MACHETAS

TIPOS, MEDIDAS Y NIVELES DE CORTE



MACHETAS

MACHETA M-1 (TRACCIÓN)

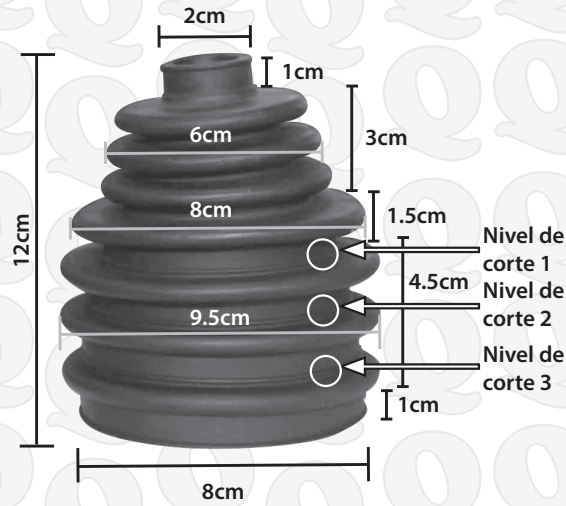

MACHETA M-2 (DIRECCIÓN)

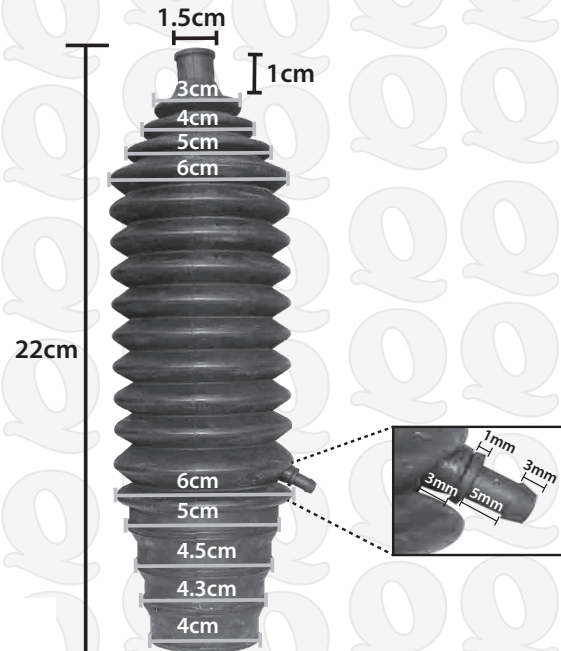

MACHETA M-3 (TRACCIÓN)

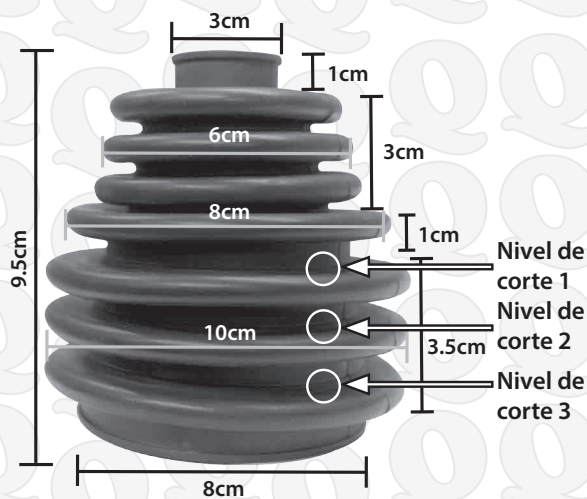

MACHETA M-4 (DIRECCIÓN)

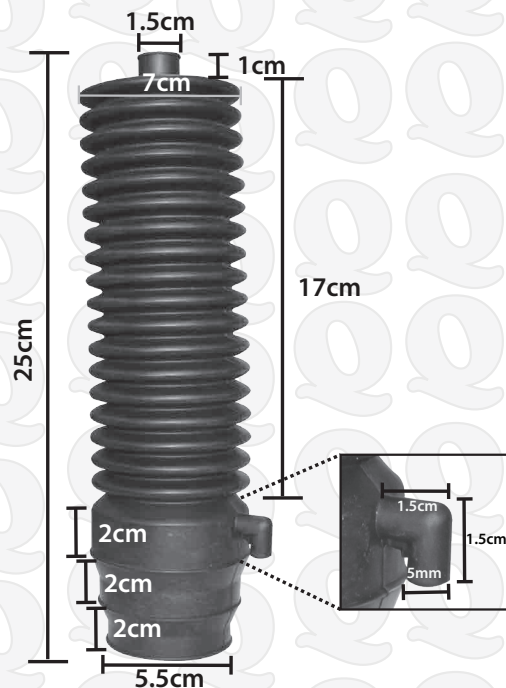



TRACCIÓN

UNIVERSALES/ GM

MACHETAS

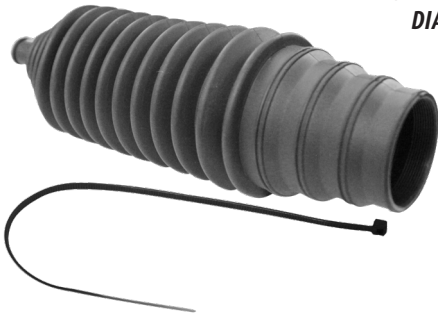

DIAM SUP 1.5 CM
DIAM INF 4 CM
ALT 22 CM

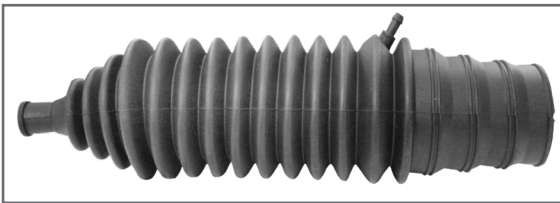

M-2

DESCRIPCIÓN	MODELO	LADO	POSICIÓN
CHRYSLER			
"K" LEBARON, MAGNUM	82/89	HID/STD	IZQ/DER
SHADOW, PHANTOM	88/89	HID/ STD	IZQ/DER
SPIRIT	90	HID/ STD	IZQ/DER
SHADOW, SPIRIT, PHANTOM,	90/95	STD	IZQ/DER
NEW YORKER			
STRATUS, CIRRUS	95/04	STD	IZQ/DER
ATOS	00/05		IZQ/DER
FORD			
TOPAZ	84/90	HID/STD	IZQ/DER
FAIRMONT	78/83	STD	IZQ/DER
G M			
CHEVY	94/04	STD	IZQ/DER
CAMIONETA	00/05		IZQ/DER
CHEVY		HID	IZQ/DER
HONDA			
CIVIC ACCORD	97/06	HID	
NISSAN			
TSURU I Y II	84/92	HID/ STD	IZQ/DER
TSURU III TSUBAME	93/05	HID	IZQ/DER
TSURU III TSUBAME	93/05	STD	IZQ/DER
PLATINA	02/05	HID	IZQ/DER
RENAULT			
CLIO	02/05	HID	IZQ/DER
VW			
GOLF Y JETTA A2 A3	87/03	HID	IZQ/DER

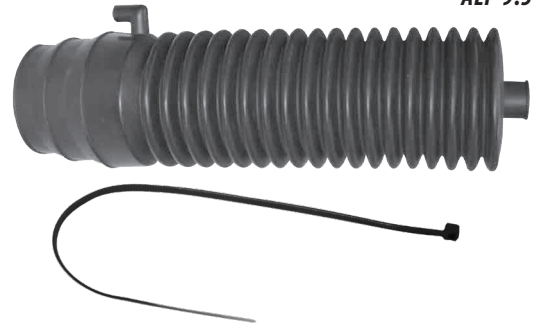

DIAM SUP 3 CM
DIAM INF 8 CM
ALT 9.5 CM

M-4

DESCRIPCIÓN	MODELO	LADO	POSICIÓN
FORD			
COUGAR THUNDER, TAURUS	84/90	HID	IZQ/DER
TOPAZ	84/91	STD	IZQ
TOPAZ GHIA	90/94	HID	IZQ/DER
FOCUS, ECOSPORT, EXPLORER, MONDEO	T0D05		IZQ/DER
LOBO GRANDE	04/11		IZQ/DER
GM			
CELEBRITY, CUTLASS, CENTURY	82/90	HID	
NISSAN			
URVAN	02/05		IZQ/DER
MICRA	04/05		IZQ/DER

GM



M-6708

DESCRIPCIÓN	MODELO	LADO	POSICIÓN
CENTURY, CUTLASS	82/90	STD	IZQ/DER

MACHETAS

FORD/PEUGEOT/SEAT/TOYOTA



MACHETAS

FORD

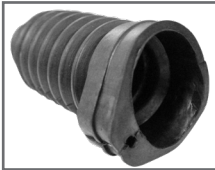

DIAM SUP 1 CM
DIAM INF 5.5 CM
ALT 17 CM

M-7600

DESCRIPCIÓN	MODELO	LADO	POSICIÓN
FAIRMONT MUSTANG COUGAR THUNDER	78/83 84/86	HID	IZQ/DER

DIAM SUP 1.2 CM
DIAM INF 5 CM
ALT 18.5 CM



M-7601

DESCRIPCIÓN	MODELO	LADO	POSICIÓN
FAIRMONT, MUSTANG	78/85	HID	IZQ/DER

PEUGEOT



DIAM SUP 3 CM
DIAM INF 9 CM
ALT 11.5 CM

M-4103

DESCRIPCIÓN	MODELO	LADO	POSICIÓN
PEUGEOT 206		HID	IZQ/DER

DIAM SUP 5 CM
DIAM INF 5 CM
ALT 16 CM



M-4104

DESCRIPCIÓN	MODELO	LADO	POSICIÓN
PEUGEOT 206CC, 306 CC, PARTNER		RUEDA	IZQ/DER

SEAT



DIAM SUP 1 CM
DIAM INF 4.5 CM
ALT 20 CM

M-1903

DESCRIPCIÓN	MODELO	LADO	POSICIÓN
IBIZA, LEON, TOLEDO, CORDOBA	02/05	DIR	IZQ/DER

TOYOTA



DIAM SUP 5.7 CM
DIAM INF 2.8 CM
ALT 20.4 CM

M-9103

DESCRIPCIÓN	MODELO	LADO	POSICIÓN
TACOMA HILUX		STD	



MACHETAS DIRECCIÓN

FORD/PEUGEOT/SEAT/TOYOTA

MACHETAS

VOLKSWAGEN



DIAM SUP 2.5 CM
DIAM INF 4 CM
ALT 13 CM



M-1100

DESCRIPCIÓN	MODELO	LADO	POSICIÓN
CARIBE ATLANTIC	77/87	STD	IZQ



DIAM SUP 2.5 CM
DIAM INF 4 CM
ALT 15 CM



M-1101

DESCRIPCIÓN	MODELO	LADO	POSICIÓN
CARIBE ATLANTIC	77/87	STD	DER



DIAM SUP 2.5 CM
DIAM INF 4 CM
ALT 11.5 CM



M-1102

DESCRIPCIÓN	MODELO	LADO	POSICIÓN
GOLF JETTA A2	87/92	STD	IZQ/DER



DIAM SUP 1.5 CM
DIAM INF 5 CM
ALT 18 CM



M-1113

DESCRIPCIÓN	MODELO	LADO	POSICIÓN
GOLF, JETTA A4	98/04		IZQ/DER



DIAM SUP 2.5 CM
DIAM INF 5.5 CM
ALT 15 CM



M-1116

DESCRIPCIÓN	MODELO	LADO	POSICIÓN
EUROVAN	00/04		IZQ/DER



DIAM SUP 1.5 CM
DIAM INF 4.5 CM
ALT 18.5 CM



M-1119

DESCRIPCIÓN	MODELO	LADO	POSICIÓN
GOLF, JETTA A4, POINTER	04/05		IZQ/DER



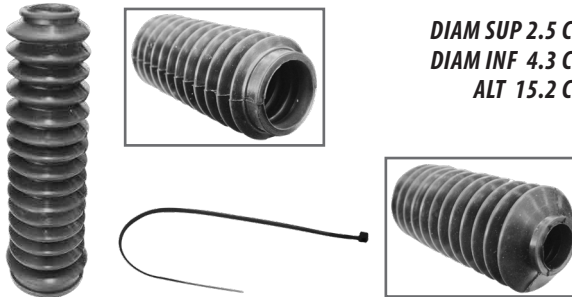

DIAM SUP 2.5 CM
DIAM INF 4.3 CM
ALT 15.2 CM

M-1120

DESCRIPCIÓN	MODELO	LADO	POSICIÓN
POINTER	98/03		IZQ/DER



MACHETAS DIRECCIÓN

VOLKSWAGEN

MACHETAS



DIAM SUP 2 CM
DIAM INF 8 CM
ALT 11.5 CM

M-1

DESCRIPCIÓN MODELO LADO POSICIÓN

DESCRIPCIÓN	MODELO	LADO	POSICIÓN
CHRYSLER			
"K" SHADOW PHANTOM	88/89	RUEDA	DER
PHANTOM, SPIRIT	90/94	RUEDA	IZQ/DER
NEON	94/98	RUEDA	IZQ/DER
STRATUS CIRRUS	95/04	CAJA	IZQ/DER
SPIRIT PHANTOM, NEW YORKER	90/95	RUEDA	IZQ/DER
SPIRIT, NEW YORKER	94/95	RUEDA	IZQ/DER
FORD			
TOPAZ	84/91	RUEDA	IZQ/DER
GHIA	91	RUEDA	IZQ/DER
THUNDER, COUGAR	89/91	CAJA/RUEDA	IZQ/DER
TAURUS	88/91	CAJA/RUEDA	IZQ/DER
GHIA	92/94	CAJA/RUEDA	IZQ/DER
TOPAZ	92/94	CAJA	IZQ/DER
ESCORT	97/02	RUEDA	IZQ/DER
CONTOUR MYSTIQUE	95/00	CAJA	IZQ/DER
GM			
CITATION, X11, CELEBRITY	82/85	CAJA/RUEDA	IZQ/DER
CUTLASS	87/91	CAJA	IZQ/DER
CAVALIER, CUTLASS, CENTURY	90/96	CAJA/RUEDA	IZQ/DER
TODOS UNIVERSAL	82/92	RUEDA	IZQ/DER
MONZA	94/04	CAJA	IZQ/DER
CAMIONETA 4X4	TODOS	RUEDA	IZQ/DER
VENTURE	99/05	RUEDA	IZQ/DER
HONDA			
CIVIC ACCORD	97/02	CAJA	IZQ/DER
IBIZA, LEON, TOLEDO, CORDOBA	02/05	RUEDA	IZQ/DER
CAMIONETAS TOYOTA PICK-UP		CAJA	IZQ/DER
NISSAN			
TSURU I, II, III	84/05	RUEDA	IZQ/DER
TSUBAME	93/05	RUEDA	IZQ/DER
SENTRA LUCCINO	98/04	CAJA/RUEDA	IZQ/DER
MAXIMA	96/05	RUEDA	IZQ/DER
RENAULT			
R18 2L (NAL.)		RUEDA	IZQ/DER
CLIO AUT	02/05	RUEDA	IZQ/DER
VW			
CARIBE ATLANTIC	77/87	RUEDA	IZQ/DER
GOLF, JETTA A2	87/92	RUEDA	IZQ/DER
CORSAR	88/91	RUEDA	IZQ/DER
GOLF JETTA DERBY	92 ½/05	RUEDA	IZQ/DER
EUROVAN	00/05	RUEDA	IZQ/DER
EURODIESEL		RUEDA	



DIAM SUP 3 CM
DIAM INF 8 CM
ALT 9.5 CM

M-3

DESCRIPCIÓN MODELO LADO POSICIÓN

DESCRIPCIÓN	MODELO	LADO	POSICIÓN
CHRYSLER			
SHADOW, PHANTOM	88/89	CAJA	IZQ
SPIRIT	90	CAJA	IZQ
SHADOW, SPIRIT PHANTOM, NEW YORKER	90/95	CAJA	IZQ/DER
ATOS	00/05	RUEDA	IZQ/DER
VERNA	04/05	RUEDA/CAJA	IZQ/DER
FORD			
TOPAZ	92/94	CAJA	IZQ/DER
GHIA	91	RUEDA	IZQ/DER
FOCUS, KA, IKON, COURIER, MONDEO, FOCUS	99/05	CAJA	IZQ/DER
GM			
CHEVY MONZA	96/99	CAJA	IZQ/DER
MATIZ		CAJA	IZQ/DER
CORSA		RUEDA	IZQ/DER
ASTRA		CAJA	IZQ/DER
NISSAN			
TSURU II	88/92	CAJA	IZQ/DER
TSURU III TSUBAME	93/05	RUEDA	IZQ/DER
PLATINA AUT	02/05	RUEDA/CAJA	IZQ/DER
MICRA	04/05	RUEDA	IZQ/DER
TIIDA	06/11		

MACHETAS TRACCIÓN

CHRYSLER



MACHETAS

CHRYSLER



DIAM SUP 3.5 CM
DIAM INF 7.0 CM
ALT 9.5 CM



M-5400

DESCRIPCIÓN	MODELO	LADO	POSICIÓN
"K" LEBARON, MAGNUM SHADOW SPIRIT	82/89 88/89 90	CAJA	DER



DIAM SUP 2 CM
DIAM INF 7.5 CM
ALT 10 CM



M-5409

DESCRIPCIÓN	MODELO	LADO	POSICIÓN
NEON	94/98	CAJA	DER



DIAM SUP 1.5 CM
DIAM INF 4.5 CM
ALT 17.5 CM



M-5410

DESCRIPCIÓN	MODELO	LADO	POSICIÓN
NEON	94/98	CAJA	IZQ

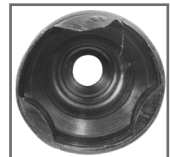

DIAM SUP 2.5 CM
DIAM INF 8 CM
ALT 11 CM



M-5412

DESCRIPCIÓN	MODELO	LADO	POSICIÓN
STRATUS, CIRRUS	95/04	CAJA	DER



M-5413

DESCRIPCIÓN	MODELO	LADO	POSICIÓN
STRATUS, CIRRUS	95/04	CAJA	IZQ



DIAM SUP 4 CM
DIAM INF 9 CM
ALT 10 CM



M-5417

DESCRIPCIÓN	MODELO	LADO	POSICIÓN
CINTAS U.S.A BOCA GRANDE		CAJA	IZQ/DER



MACHETAS TRACCIÓN

CHRYSLER/ FORD

MACHETAS



DIAM SUP 2 CM
DIAM INF 6.5 CM
ALT 9.2 CM



M-5420

DESCRIPCIÓN	MODELO	LADO	POSICIÓN
ATOS	00/05	CAJA	IZQ/DER



DIAM SUP 2.1 CM
DIAM INF 6 CM
ALT 8.2 CM

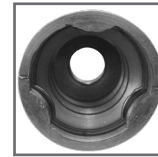

M-5424

DESCRIPCIÓN	MODELO	LADO	POSICIÓN
VERNA STD	04/05	CAJA	IZQ/DER



DIAM SUP 2.2 CM
DIAM INF 6.8 CM
ALT 8.2 CM



M-5425

DESCRIPCIÓN	MODELO	LADO	POSICIÓN
VERNA AUT	04/05	CAJA	IZQ/DER

FORD



DIAM SUP 2 CM
DIAM INF 6.5 CM
ALT 12 CM



M-7609

DESCRIPCIÓN	MODELO	LADO	POSICIÓN
TOPAZ GHIA	84/91 91	CAJA	IZQ/DER



DIAM SUP 2.5 CM
DIAM INF 7.5 CM
ALT 12 CM

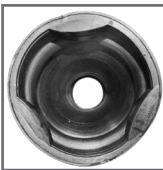

M-7618

DESCRIPCIÓN	MODELO	LADO	POSICIÓN
FIESTA	98/01	CAJA	IZQ/DER



DIAM SUP 2 CM
DIAM INF 8.3 CM
ALT 10 CM

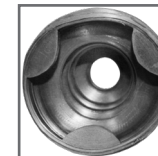

M-7621

DESCRIPCIÓN	MODELO	LADO	POSICIÓN
KA, IKON, COURIER	99/05	CAJA	IZQ/DER

MACHETAS TRACCIÓN

FORD/ GENERAL MOTORS



MACHETAS

DIAM SUP 7.5 CM
DIAM INF 2 CM
ALT 7.8 CM

M-7626

DESCRIPCIÓN	MODELO	LADO	POSICIÓN
ECOSPORT, FOCUS		CAJA	

GENERAL MOTORS

DIAM SUP 2.5 CM
DIAM INF 9 CM
ALT 15.5 CM

M-6702

DESCRIPCIÓN	MODELO	LADO	POSICIÓN
CUTLASS	87/91	RUEDA	IZQ/DER

DIAM SUP 2 CM
DIAM INF 6.5 CM
ALT 12 CM

M-6709

DESCRIPCIÓN	MODELO	LADO	POSICIÓN
TODOS UNIVERSAL	82/90	CAJA	IZQ/DER

DIAM SUP 2.5 CM
DIAM INF 9 CM
ALT 10.5 CM

M-6711

DESCRIPCIÓN	MODELO	LADO	POSICIÓN
AMERICANOS GRANDES		CAJA	IZQ/DER

DIAM SUP 2.5 CM
DIAM INF 9 CM
ALT 12 CM

M-6712

DESCRIPCIÓN	MODELO	LADO	POSICIÓN
AMERICANOS MEDIANA		CAJA	IZQ/DER

DIAM SUP 2.1 CM
DIAM INF 8 CM
ALT 11 CM

M-6713

DESCRIPCIÓN	MODELO	LADO	POSICIÓN
AMERICANOS CHICA		CAJA	IZQ/DER



MACHETAS TRACCIÓN

GENERAL MOTORS/HONDA

MACHETAS



DIAM SUP 2.8 CM
DIAM INF 9 CM
ALT 10 CM

M-6714

DESCRIPCIÓN	MODELO	LADO	POSICIÓN
AMERICANOS	TODOS	RUEDA	IZQ/DER



DIAM SUP 2.5 CM
DIAM INF 9.5 CM
ALT 12 CM

M-6719

DESCRIPCIÓN	MODELO	LADO	POSICIÓN
AMERICANOS EXTRA GRANDE		CAJA	IZQ/DER



DIAM SUP 2 CM
DIAM INF 7.5 CM
ALT 10.7 CM

M-6720

DESCRIPCIÓN	MODELO	LADO	POSICIÓN
CHEVY MONZA	00/04	CAJA	IZQ/DER



DIAM SUP 2.1 CM
DIAM INF 6.4 CM
ALT 8.3 CM

M-6723

DESCRIPCIÓN	MODELO	LADO	POSICIÓN
MATIZ		CAJA	

HONDA



DIAM SUP 2.5 CM
DIAM INF 8 CM
ALT 10 CM

M-9800

DESCRIPCIÓN	MODELO	LADO	POSICIÓN
CIVIC ACCORD	97/02	CAJA	IZQ/DER



DIAM SUP 2.2 CM
DIAM INF 7.5 CM
ALT 9 CM

M-9803

DESCRIPCIÓN	MODELO	LADO	POSICIÓN
CIVIC ACCORD	02/06	CAJA	

MACHETAS TRACCIÓN

NISSAN



MACHETAS

NISSAN



DIAM SUP 2 CM
DIAM INF 6.5 CM
ALT 12 CM

M-9203

DESCRIPCIÓN	MODELO	LADO	POSICIÓN
TSURU I	84/87	CAJA	IZQ/DER



DIAM SUP 2.5 CM
DIAM INF 8 CM
ALT 10 CM

M-9215

DESCRIPCIÓN	MODELO	LADO	POSICIÓN
TSURU III GS	93/05	CAJA	IZQ/DER



DIAM SUP 4 CM
DIAM INF 9 CM
ALT 8.3 CM

M-9216

DESCRIPCIÓN	MODELO	LADO	POSICIÓN
PLATINA STD	02/05	CAJA	IZQ/DER



DIAM SUP 2.5 CM
DIAM INF 8.7 CM
ALT 12.3 CM

M-9217

DESCRIPCIÓN	MODELO	LADO	POSICIÓN
PLATINA STD	02/05	RUEDA	IZQ/DER



DIAM SUP 2.5 CM
DIAM INF 7.5 CM
ALT 10 CM

M-9219

DESCRIPCIÓN	MODELO	LADO	POSICIÓN
PLATINA AUT	02/05	CAJA	IZQ/DER



DIAM SUP 2.4 CM
DIAM INF 8.3 CM
ALT 9 CM

M-9223

DESCRIPCIÓN	MODELO	LADO	POSICIÓN
ALMERA	00/05	CAJA	IZQ/DER



MACHETAS TRACCIÓN

NISSAN/ PEUGEOT

MACHETAS



DIAM SUP 2.8 CM
DIAM INF 8.5 CM
ALT 10 CM



M-9224

DESCRIPCIÓN	MODELO	LADO	POSICIÓN
CAMIONETAS 4X4 AMERICANAS	TODOS	RUEDA	IZQ/DER

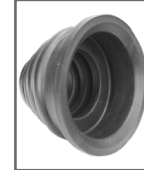

DIAM SUP 7.6 CM
DIAM INF 4.1 CM
ALT 7.2 CM



M-9229

DESCRIPCIÓN	MODELO	LADO	POSICIÓN
APRIO		CAJA	IZQ/DER

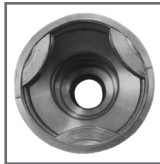

DIAM SUP 8.2 CM
DIAM INF 2.4 CM
ALT 9.3 CM



M-9232

DESCRIPCIÓN	MODELO	LADO	POSICIÓN
TIIDA	06/11	CAJA	

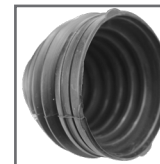

M-9235

DESCRIPCIÓN	MODELO	LADO	POSICIÓN
X-TRAIL		RUEDA	

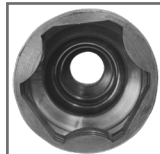

DIAM SUP 9 CM
DIAM INF 2.5 CM
ALT 8.5 CM



M-9236

DESCRIPCIÓN	MODELO	LADO	POSICIÓN
X-TRAIL		CAJA	IZQ/DER

PEUGEOT

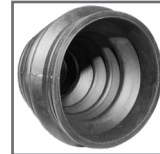

DIAM SUP 3.6 CM
DIAM INF 8 CM
ALT 10.9 CM



M-4100

DESCRIPCIÓN	MODELO	LADO	POSICIÓN
TODOS	00/05	RUEDA	IZQ/DER

MACHETAS TRACCIÓN

PEUGEOT/RENAULT



MACHETAS



DIAM SUP 2.9 CM
DIAM INF 2 CM
ALT 8 CM



M-4101

DESCRIPCIÓN	MODELO	LADO	POSICIÓN
TODOS STD	00/05	CAJA	IZQ/DER





DIAM SUP 3.3 CM
DIAM INF 7.7 CM
ALT 9.7 CM





M-4102

DESCRIPCIÓN	MODELO	LADO	POSICIÓN
TODOS AUT	00/05	CAJA	IZQ/DER

RENAULT





DIAM SUP 2 CM
DIAM INF 7 CM
ALT 11.5 CM





M-4304

DESCRIPCIÓN	MODELO	LADO	POSICIÓN
R18 2.0L(NAL.)		CAJA	IZQ/DER

DIAM SUP 3.5 CM
DIAM INF 9.5 CM
ALT 9 CM

M-4311

DESCRIPCIÓN	MODELO	LADO	POSICIÓN
ALLIANCE, ENCORE	TODOS	CAJA	IZQ



DIAM SUP 4 CM
DIAM INF 9 CM
ALT 8.3 CM





M-4319

DESCRIPCIÓN	MODELO	LADO	POSICIÓN
CLIO STD.	02/05	CAJA	IZQ/DER



DIAM SUP 2.5 CM
DIAM INF 8.7 CM
ALT 12.3 CM

M-4320

DESCRIPCIÓN	MODELO	LADO	POSICIÓN
CLIO STD.	02/05	RUEDA	IZQ/DER

MACHETAS TRACCIÓN

SEAT/ TOYOTA/ VOLKSWAGEN

SEAT



DIAM SUP 3 CM
DIAM INF 10 CM
ALT 11.5 CM

M-1902

DESCRIPCIÓN	MODELO	LADO	POSICIÓN
IBIZA, LEON, TOLEDO, CORDOBA	02/05	CAJA	IZQ/DER

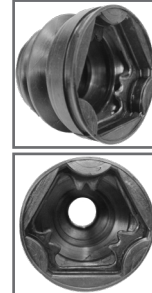

DIAM SUP 3 CM
DIAM INF 9 CM
ALT 11.5 CM

M-1904

DESCRIPCIÓN	MODELO	LADO	POSICIÓN
SHARAN		CAJA	IZQ/DER

TOYOTA

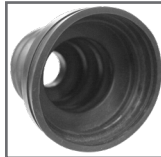

DIAM SUP 1 CM
DIAM INF 4.5 CM
ALT 20 CM

M-9100

DESCRIPCIÓN	MODELO	LADO	POSICIÓN
CAMIONETAS TOYOTA 4X4		RUEDA	IZQ/DER

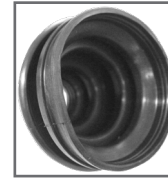

DIAM SUP 3 CM
DIAM INF 9 CM
ALT 9 CM

M-9101

DESCRIPCIÓN	MODELO	LADO	POSICIÓN
CAMIONETAS TOYOTA 4X4			IZQ/DER

VOLKSWAGEN



DIAM SUP 2 CM
DIAM INF 9.5 CM
ALT 9 CM

M-1105

DESCRIPCIÓN	MODELO	LADO	POSICIÓN
CARIBE GOLF, JETTA A2 CORSA	77/87 87/92 88/91	CAJA	IZQ/DER



DIAM SUP 4.5 CM
DIAM INF 9 CM
ALT 14 CM

M-1107



DESCRIPCIÓN	MODELO	LADO	POSICIÓN
SEDAN (TRASERA)	TODOS		IZQ/DER

TAMBIÉN DISPONIBLE EN ROJO(M-1107-R) y AZUL (M-1107-A)

MACHETAS TRACCIÓN

VOLKSWAGEN



MACHETAS

DIAM SUP 4.5 CM
DIAM INF 9 CM
ALT 14 CM

M-1107-A



DESCRIPCIÓN	MODELO	LADO	POSICIÓN
SEDAN (TRASERA) AZUL	TODOS		IZQ/DER

DIAM SUP 4.5 CM
DIAM INF 9 CM
ALT 14 CM

M-1107-R



DESCRIPCIÓN	MODELO	LADO	POSICIÓN
SEDAN (TRASERA) ROJA	TODOS		IZQ/DER

DIAM SUP 2.3 CM
DIAM INF 10 CM
ALT 8.5 CM

M-1108

DESCRIPCIÓN	MODELO	LADO	POSICIÓN
COMBI (INT. Y EXT.)	70/01		IZQ/DER

DIAM SUP 2 CM
DIAM INF 10 CM
ALT 9.5 CM

M-1109



DESCRIPCIÓN	MODELO	LADO	POSICIÓN
JETTA, VR6	92/96	CAJA	IZQ

DIAM SUP 3.5 CM
DIAM INF 9 CM
ALT 11.5 CM

M-1110

DESCRIPCIÓN	MODELO	LADO	POSICIÓN
GOLF, JETTA, DERBY	92/96	CAJA	DER

DIAM SUP 3 CM
DIAM INF 10 CM
ALT 11.5 CM

M-1112

DESCRIPCIÓN	MODELO	LADO	POSICIÓN
GOLF, JETTA, DERBY	92/96	CAJA	IZQ



MACHETAS TRACCIÓN

VOLKSWAGEN

MACHETAS



DIAM SUP 2.5 CM
DIAM INF 6 CM
ALT 9.7 CM



M-1115

DESCRIPCIÓN	MODELO	LADO	POSICIÓN
EUROVAN	00/05		IZQ/DER



DIAM SUP 2 CM
DIAM INF 8 CM
ALT 9 CM



M-1117

DESCRIPCIÓN	MODELO	LADO	POSICIÓN
GOLF, JETTA A4, BEETLE AUTOMÁTICO	98/05	CAJA	IZQ/DER

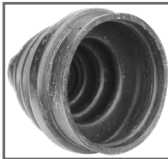

DIAM SUP 2 CM
DIAM INF 7 CM
ALT 10 CM



M-1118

DESCRIPCIÓN	MODELO	LADO	POSICIÓN
GOLF, JETTA A4, BEETLE STD	98/05	CAJA	IZQ/DER

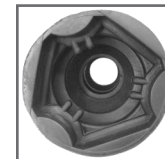

DIAM SUP 2.5 CM
DIAM INF 4.3 CM
ALT 15.2 CM



M-1121

DESCRIPCIÓN	MODELO	LADO	POSICIÓN
GOLF, JETTA, BORA	06	CAJA	IZQ/DER



- 1. Repuesto de TRÍPODE
- 2. Macheta tipo 1
- 2.1 Macheta tipo2
- 3. Balero fijo
- 4. Balero loco
- 5. Abrazaderas
- 6. Abrazaderas sin fin
- 7.Grasa



TRACCIÓN

ESQUEMA DEL TRÍPODE Y REPUESTO

TRÍPODES

REPUESTO DE TRÍPODE, REPARACIÓN EFECTIVA Y ECONÓMICA, SIEMPRE Y CUANDO LOS DIENTES DEL TRÍPODE ESTÉN EN BUENAS CONDICIONES:

RT-2995-JGO, RT-3395-JGO, RT-21815A1-JGO, RT-32715-A-JGO

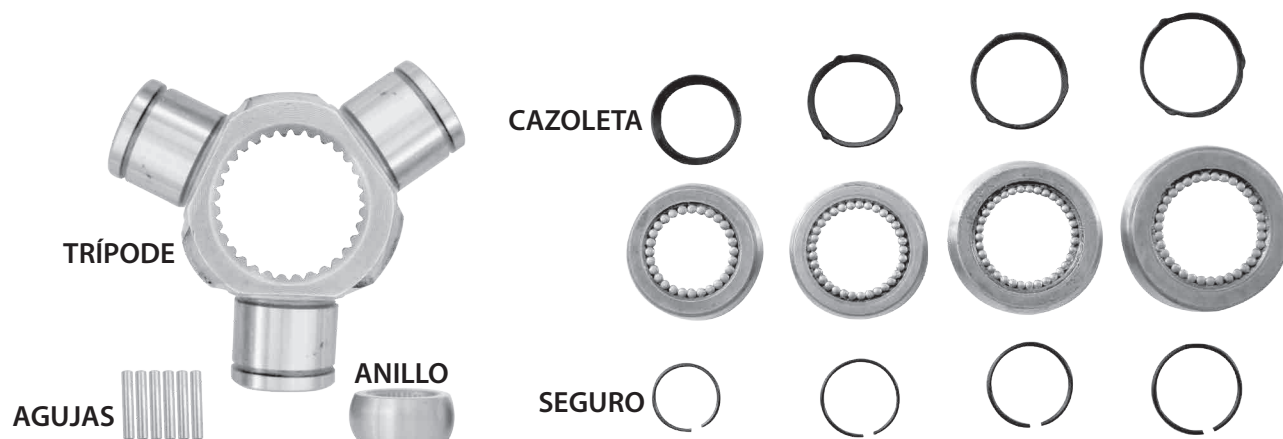

REPUESTO DE TRÍPODE



RT-2995-JGO

1.177 MED 3 PZS

DADO CHICO

CHRYSLER "K" NEON, SHADOW, TOPAZ, GHIA, TAURUS, IKON, FIESTA, CITATION, CELEBRITY, CHEVY, TSURU I-II-III, TSUBAME, PLATINA, CLIO R-5, R-12, R-18, ALLIANCE, ISUZU, ESCORT

77/UP



RT-3395-JGO

1.336 MED 3 PZS

DADO GRANDE

SPIRIT, SHADOW, PT CRUISER, NEON C/ABS Y S/ABS COUGAR, THUNDERBIRD, CENTURY, CUTLASS, CAVALIER, R-18, RIN 15 2.0L

80/UP

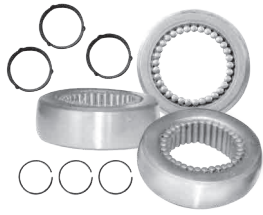

RT-21815A1-JGO

1.196 MED	3 PZS	DADO MEDIANO	
FORD IKON, KA, COURIER FIESTA			01/UP 98/UP

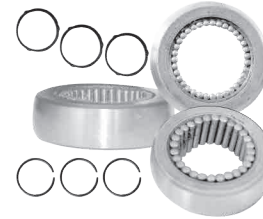

RT-32715-A-JGO

1.460 MED	3 PZS	DADO EXTRA - GRANDE	
CHRYSLER CIRRUS, STRATUS, VOYAGER TAURUS, SABLE, WINDSTAR THUNDERBIRD, COUGAR MAZDA SENTRA, LUCINO TOYOTA			96/99 88/99 89/97 93/99 96/98 92/96

KIT DE REPUESTO DE TRÍPODE CON MACHETA



KIT-2995

REF. RT-2995-JGO			
1.177 MED		DADO CHICO	
KIT MACHETA UNIVERSAL Y REP. TRICETA, L/CAJA			VARIOS



KIT-3395

REF. RT-3395-JGO			
1.336 MED		DADO GRANDE	
KIT MACHETA UNIVERSAL Y REP. TRICETA L/CAJA			VARIOS



KIT-21815A1

REF. RT-21815A1-JGO			
1.196 MED		DADO MEDIANO	
KIT MACHETA UNIVERSAL Y REP. TRICETA, L/CAJA			VARIOS



KIT-32715-A

REF. RT-32715-A-JGO			
1.460 MED		DADO EXTRA - GRANDE	
KIT MACHETA UNIVERSAL Y REP. TRICETA, L/CAJA			VARIOS



TRACCIÓN

TRÍPODES

TRÍPODES



19015

19 DIENTES

TRÍPODE GM
MATIZ

04/09



19182

19 DIENTES 1,143 MED

TRÍPODE HYUNDAI
ATOS (1ra GENERACIÓN)

00/04



19414

19 DIENTES 1,143 MED
(DADO GRANDE)

TRÍPODE GM
MATIZ G1



20038

20 DIENTES ANILLOS DE
29.33mm D.

TRÍPODE HYUNDAI
I-10 4 CIL 1.2L Y 1.3L

10/14



20238

20 DIENTES 1,148 MED

TRÍPODE HYUNDAI
ATOS

05/UP



21211

21 DIENTES 1,178 MED
RT-2995

REF.: 327747

TRÍPODE RENAULT 5
TRÍPODE ISUZU

74/84
83/93



21815A

21 DIENTES 1,197
RT-2995

REF.: 327748

TRÍPODE FORD
FIESTA
IKON, KA, COURIER

98/UP
01/UP



22025

22 DIENTES

TRÍPODE PEUGEOT
206
PARTNER
NEON

TODOS
TODOS
00/UP



22155

22 DIENTES

TRÍPODE PEUGEOT
206
306
405

01/07
01/07
01/07



22184

22 DIENTES		
<i>TRÍPODE TOYOTA</i> TERCEL		91/94
<i>TRÍPODE HYUNDAI</i>		
<i>TRÍPODE HONDA</i> CIVIC		02/05
<i>TRÍPODE FORD</i> ESCORT ZX2		97/03
<i>TRÍPODE MAZDA</i> PROTEGE 323		86/98
<i>TRÍPODE CHRYSLER</i> NEON		00/UP
VERNA		04/06
ATTITUDE		06/11
<i>TRÍPODE ISUZU</i> GEO STORM		90/93



22211

22 DIENTES	1.178 MED RT-2995	
<i>TRÍPODE RENAULT</i> 12,18, CLIO SPORT STD KANGOO		72/83 00/06
<i>TRÍPODE NISSAN</i> PLATINA		02/05
<i>TRÍPODE FORD</i> C/FLECHA P/22DIENTES		95/UP
FIESTA IKON		01/UP
KA		01/05
<i>TRÍPODE PONTIAC</i> AZTEC		04/12



23030

23 DIENTES	1.333 MED.	
<i>TRÍPODE NISSAN</i> TSURU III		04/07
<i>TRÍPODE CHRYSLER</i> NEON		03/05
<i>TRÍPODE FORD</i> FOCUS ECOSPORT		00/05 03/07



23164

23 DIENTES	1.298 MED	
<i>TRÍPODE NISSAN</i> HIKARI SENTRA		87/92 96/00



23174

23 DIENTES	1.337 MED.	
REF.: 327546, 327547		
<i>TRÍPODE CHRYSLER</i> PT CRUISER C/ABS Y S/ABS NEON C/ABS Y S/ABS		00/04 00/05
<i>TRÍPODE RENAULT</i> 18, 2.0 LTS		84/86



23276

23 DIENTES		
<i>TRÍPODE HONDA</i> CIVIC		01/10
<i>TRÍPODE GM</i> ASTRA		06/08
<i>TRÍPODE FORD</i> FOCUS EUROPEO (BALERO LOCO)		06/10



TRACCIÓN

TRÍPODES

TRÍPODES



23537

23 DIENTES 1.500 MED

TRÍPODE TOYOTA
COROLLA
RAV4

89/91
88/92



23537A

23 DIENTES 1.177 MED

TRÍPODE TOYOTA
TERCEL
CELICA
YARIS

80/88
80/88
08/09



24211

24 DIENTES 1.178 MED
RT-2995

TRÍPODE GM

CITATION, CELEBRITY, X-11,
CENTURY SS.

82/88

TRÍPODE CHRYSLER

DART, VOLARE, LE BARON, NEW
YORKER, PHANTOM, SHADOW,
SPIRIT.

82/90

TRÍPODE FORD

TOPAZ y GHIA.

84/91

TRÍPODE NISSAN

TSURU I, II, III, TSUBAME

84/00

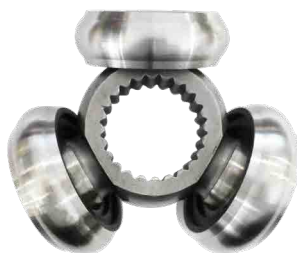

24335

24 DIENTES

TRÍPODE MAZDA
MAZDA 3
TRÍPODE FORD
FOCUS EUROPA
VOLVO S40
(BALERO LOCO)

03/09
09/12



24715B

24 DIENTES

TRÍPODE NISSAN

EQUINOX, TORRENT
SENTRA

05/08
07/11

TRÍPODE GM

CAPTIVA

08/10

TRÍPODE MAZDA

MAZDA 3, 5 STD

06/10

TRÍPODE LAND ROVER

LAND ROVER

98/99

FREE LANDER

99/06

TRÍPODE TOYOTA

CAMRY 4 CIL

97/00

TRÍPODE VOLVO

C70, S70, V70, S60

01/07



25174

25 DIENTES 1.337 MED
RT-2995

TRÍPODE GM

CENTURY, CUTLASS, EUROSPORT, CAVALIER
CAVALIER Z-24
CENTURY

90/98
90/98
90/97

TRÍPODE CHRYSLER

SHADOW, SPIRIT
TODOS TURBO NAL. E IMP.

TODOS
90/94

CHRYSLER 400

87/88

LEBARON GTS

87/90

SHADOW

87/94

SPIRIT

89/94

VOYAGER

87/95

STRATUS S/ABS

90/94

TRÍPODE FORD

GHIA

92/94

THUNDERBIRD

88/94

TRÍPODE VOLVO

SERIE 70 (C70, V70, S70)

98/99

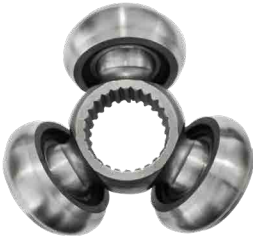

26021

26 DIENTES

TRÍPODE NISSAN
QUEST

04/10

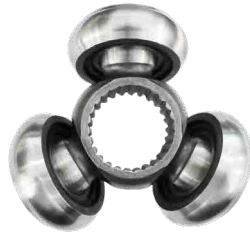

26040

26 DIENTES

TRÍPODE NISSAN
X-TRAIL
TRÍPODE VOLVO
S40, S60, S80, C70
(BALERO LOCO)

02/07

00/06



28211

28 DIENTES

1.178 MED
RT-2995

REF.: 326931

TRÍPODE GM

CHEVY POP
JOY, SWING y MONZA

96/98

96/98

TRÍPODE CHRYSLER

NEÓN
NEW YORKER NO TURBO
SPIRIT NO TURBO

95/99

84/UP

89/90

TRÍPODE FORD
TOPAZ- GHIA

NUEVO



27045

TRÍPODE TOYOTA
RAV4

00/06

NUEVO



27059

TRÍPODE TOYOTA
TOYOTA SIENNA, CAMRY

05/10

NUEVO



28500

28 DIENTES

TRÍPODE GM
CORSA
TORNADO

05/UP
04/07



29057

TRÍPODE CHEVROLET
AVEO
SPARK
TRÍPODE PONTIAC
G3

08/17
11/15

06/09



29077

29 DIENTES

TRÍPODE MAZDA
MAZDA 2



TRACCIÓN

TRÍPODES

TRÍPODES



29915

29 DIENTES 1.337 MED

TRÍPODE GM

CAVALIER	85/88
PONTIAC SUNFIRE,	96/UP
GRAND AM	
BUICK, CHEVROLET, GEO,	
GMC,	
OLDSMOBILE, OPEL, PONTIAC,	85/90
GRAND AM	92/94
GRAND PRIX	90/94
LUMINA	



30035

30 DIENTES 1.456 MED

TRÍPODE VW

GOLF JETTA A4 4 CIL 2.0L	99/01
TRANS. AUTO. y STD.	
AUDI QUATTRO	00/02
AUDI TT	00/02
GOLF GTI	99/06
GOLF	99/06
JETTA	99/05
NEW BEETLE	01/05
VW R-3299-06	

(BALERO LOCO)



NUEVO

30062

TRÍPODE HONDA
CRV 12/16



31049

31 DIENTES

TRÍPODE CHEVROLET
CRUZE, SONIC TODOS



30715B

30 DIENTES 1.46 MED

TRÍPODE FORD

TAURUS	86/93
MERCURY SABLE	86/93



30211

30 DIENTES 1.177 MED

TRÍPODE NISSAN	TODOS
PLATINA	
TRÍPODE CHRYSLER	83/95
VOYAGER	
CARAVAN AMERICANA	



32214A

32 DIENTES

TRÍPODE FORD	01/12 95/00
ESCAPE 32X35 32X34	
MYSTIQUE CONTOUR 2.5L,	
32X26	
(BALERO LOCO)	



32235

32 DIENTES	1.455 MED	
TRÍPODE GM CAVALIER (RODILLO PLANO)		88/90

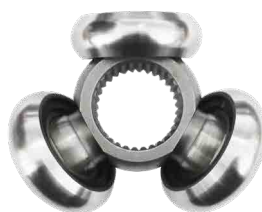

32300

32 DIENTES		
TRÍPODE VW AUDI NEW BEETLE NB BORA 32X26 ACURA RDX 32X29 32X27 (BALERO LOCO)		05/09 06/09 06/10 07/10



32335

32 DIENTES	1.614 MED	
TRÍPODE FORD CONTOUR Y MYSTIQUE TRÍPODE HONDA CIVIC (BALERO LOCO)		95/00



32440

32 DIENTES	1.454 MED	
TRÍPODE GM CAVALIER CENTURY, CUTLASS 2.8 Y 3.7L		88/94 TODOS



32715A

32 DIENTES	1.46 MED	
C/SEGURO	RT-32715-A-JGO	
TRÍPODE CHRYSLER CIRRUS, STRATUS VOYAGER SPIRIT TRÍPODE FORD TAURUS, SABLE, WINDSTAR THUNDERBIRD, COUGAR TRÍPODE MAZDA TRÍPODE NISSAN SENTRA, LUCINO TSURU III TRÍPODE TOYOTA		96/99 91/95 88/99 89/97 93/99 96/98 00/02 92/96



32715A1

32 DIENTES	1.46 MED	
S/SEGURO	RT-32715-A-JGO	
TRÍPODE CHRYSLER CIRRUS, STRATUS VOYAGER SPIRIT TRÍPODE FORD TAURUS, SABLE, WINDSTAR THUNDERBIRD, COUGAR TRÍPODE MAZDA TRÍPODE NISSAN SENTRA, LUCINO TSURU III TRÍPODE TOYOTA		96/99 91/95 88/99 89/97 93/99 96/98 00/02 92/96



32440-E

32 DIENTES	1.454 MED	
TRÍPODE GM AZTEC VENTURE		01/04 00/05



TRACCIÓN

TRÍPODES

TRÍPODES



32441

32 DIENTES

TRÍPODE CHRYSLER

SHADOW

CIRRUS

STRATUS

PLYMOUTH BREEZE

EAGLE VISION

91/94

95/98

95/98

96/98

93/97



NUEVO

33101

33 DIENTES

TRÍPODE NISSAN

XTRAIL, ALTIMA

TRÍPODE RENAULT

DUSTER

08/18



34040

34 DIENTES

1.698 MED

TRÍPODE VW

BEETLE

SHARAN 1.8L

GOLF JETTA A4 1.8L, 2.0L

TRANS. AUTO. Y STD.

ALHAMBRA

AUDI A4/S4

A4/S4 S-LINE

AUDI A6/S6

GOLF A4

JETTA A4

PASSAT

(BALERO LOCO)

98/05

02/UP

02/UP

02/UP

02/UP

02/UP

02/UP

02/UP

02/UP

02/UP



34175

34 DIENTES

1.454 MED

TRÍPODE PEUGEOT

PEUGEOT 307

PARTNER

03/09

04/11



34178

34 DIENTES

TRÍPODE FORD

RANGER

EXPLORER 4X4

MOUNTAINER 4X4

TRÍPODE NISSAN

QUEST

98/00

95/02

97/98

04/09



34335

34 DIENTES

1.612 MED

TRÍPODE FORD

MONDEO AUTOM 6 CIL

TRÍPODE VW

GOLF JETTA AUTOM A3

PASSAT AUTOM VR6

BEETLE VR6 AUTOM

(BALERO LOCO)

02/07

94/99

00/02

99/07



34716AX

34 DIENTES

1.612 MED

TRÍPODE TOYOTA

TACOMA 3.4L, 6 CIL

4 RUNNER 2.7L, 4 CIL

95/04

96/02



NUEVO

34440F

TRÍPODE PONTIAC

GRAND PRIX SUPERCHARGED

34 X 39 D.E. (R)

GRAND PRIX SUPERCHARGED

34 X 34 D.E.M (R)

TRÍPODE CHEVROLET

VARIOS 34 X 34 D.I.H. RETEN 35MM,

IMPALA 34 X 34 D.E.M. RETEN 35MM

TRAIL BLAZER 34 X 26 D.E.M. RETEN 40MM

VARIOS 34 X 26 D.I.H. RETEN 40MM

1997

1997

99/05

00/03

97/06

97/06



NUEVO

35051

TRÍPODE HONDA

PILOT

TRÍPODE MITSUBISHI

ENDEAVOUR

OUTLANDER

03/08

03/11
09/15



NUEVO

35816A

TRÍPODE PONTIAC

PICK UPS

AVALANCHE 35 D TIPO BRIDA (L/R),
DODGE DAKOTA, DURANGO 35 X 29 H (L/R)
DODGE RAM 2500 PICKUP 35 X 29 H (L/R)

92/09

02/06
00/04
06/UP



TRACCIÓN

TRÍPODES / TRÍPODE CON MACHETA

TRÍPODES



G-UDS

GRASA PARA TRÍPODE Y JUNTA HOMOCINÉTICA.



A-1

JUEGO DE 2 ABRAZADERAS SIN FIN PARA MACHETA UNIVERSAL



A-2

JUEGO DE 2 ABRAZADERAS LISAS PARA MACHETA UNIVERSAL



A-3

JUEGO DE 2 ABRAZADERAS C/ TORNILLO PARA MACHETA UNIVERSAL



M-1

REF. VEL-CON 325205

MACH L/R UNIVERSAL (DIRECCIÓN) CHRYSLER

"K" NEON, SHADOW, TOPAZ, GHIA, TAURUS, CITATION, CELEBRITY, CHEVY, TSURU I B11, TSURU II B12 Y TSURU III B13, TSUBAME, R-5, R-12, ALLIANCE. VW CARIBE, GOLF, JETTA

TODOS



M-3

MACHETA UNIVERSAL DE TRACCIÓN (Corta) LADO: RUEDA



19182-M1

19 DIENTES	1.143 MED	
<i>TRÍPODE HYUNDAI C/MACHETA</i> ATOS 1ra GENERACIÓN		00/04



19414-M1

19 DIENTES	1.143 MED	
<i>TRÍPODE GM C/MACHETA</i> MATIZ G1		



20238-M1

20 DIENTES	1.148 MED	
<i>TRÍPODE HYUNDAI C/MACHETA</i> ATOS		05/UP



21211-M1

REF: 327747		
21 DIENTES	1.178 MED RT-2995	
<i>TRÍPODE C/MACHETA</i> RENAULT 5 ISUZU		74/84 83/93



21815A-M1

REF: 327748		
21 DIENTES	1.197 MED RT-2995	
<i>TRÍPODE FORD C/MACHETA</i> IKON, KA. COURIER FIESTA		01/UP 98/UP



22184-M1

22 DIENTES		
<i>TRÍPODE TOYOTA C/MACHETA</i> TERCEL		91/94
<i>TRÍPODE HYUNDAI C/MACHETA</i> HYUNDAI		
<i>TRÍPODE HONDA C/MACHETA</i> HONDA CIVIC		02/05
<i>TRÍPODE FORD C/MACHETA</i> ESCORT ZX2		97/03
<i>TRÍPODE MAZDA</i> PROTEGE 323		86/98
<i>TRÍPODE CHRYSLER C/MACHETA</i> NEON		00/UP
VERNA		04/06
ATTITUDE		06/11
<i>TRÍPODE ISUZU</i> GEO STROM		90/93



22025-M1

22 DIENTES		
<i>TRÍPODE PEUGEOT C/MACHETA</i> 206 PARTNER		TODOS TODOS
<i>TRÍPODE CHRYSLER C/MACHETA</i> NEON		00/UP



22155-M1

22 DIENTES		
<i>TRÍPODE PEUGEOT C/MACHETA</i> 206 306 405		01/07 01/07 01/07



TRACCIÓN

TRÍPODE CON MACHETA

TRÍPODE CON MACHETA



22211-M1

22 DIENTES | 1.178 MED
RT-2995

TRÍPODE RENAULT C/MACHETA	
12,18, CLIO SPORT STD KANGOO	72/83 00/06 01/05
TRÍPODE NISSAN C/MACHETA	
PLATINA	02/05
TRÍPODE FORD C/FLECHA P/22 DIENTES	
FIESTA IKON KA	95/UP 01/UP
TRÍPODE PONTIAC C/MACHETA	
AZTEC	04/12



23030-M1

23 DIENTES | 1.333 MED

TRÍPODE NISSAN C/MACHETA	
TSURU III	04/07
TRÍPODE CHRYSLER C/MACHETA	
NEON	03/05
TRÍPODE FORD C/MACHETA	
FOCUS ECOSPORT	00/05 03/07



23164-M1

23 DIENTES | 1.298 MED

TRÍPODE NISSAN C/MACHETA	
HIKARI SENTRA B16	87/92 96/00



23276-M1

23 DIENTES

TRÍPODE HONDA C/MACHETA	
CIVIC	01/10
TRÍPODE GM C/MACHETA	
ASTRA	06/08
TRÍPODE FORD C/MACHETA	
FOCUS EUROPEO (BALERO LOCO)	06/10



23537-M1

23 DIENTES | 1.500 MED

TRÍPODE TOYOTA C/MACHETA	
COROLLA RAV 4	89/91 88/92



23174-M1

REF: 327546, 327547

23 DIENTES | 1.337 MED.

TRÍPODE CHRYSLER C/MACHETA	
PT CRUISER C/ABS Y S/ABS NEON C/ABS Y S/ABS	00/04 00/05
TRÍPODE RENAULT C/MACHETA	
RENAULT 18., 2.0L	84/86



23537A-M1

23 DIENTES 1.177 MED

TRÍPODE TOYOTA C/MACHETA

CELICA	80/88
YARIS	08/09
TERCEL	80/88



24211-M1

24 DIENTES 1.178 MED
RT-2995

TRÍPODE GM C/MACHETA

CITATION, CELEBRITY, X-11, CENTURY SS. 82/88

TRÍPODE CHRYSLER C/MACHETA

DART, VOLARE, LE BARON, NEW YORKER, PHANTOM, SHADOW, SPIRIT 82/90

TRÍPODE FORD C/MACHETA

TOPAZ y GHIA. 84/91

TRÍPODE NISSAN C/MACHETA

TSURU I, II, III, TSUBAME 84/00



25174-M1

25 DIENTES 1.337 MED
RT-2995

TRÍPODE GM C/MACHETA

CENTURY, CUTLASS, 90/98

EUROSPORT, CAVALIER, Z-24

TRÍPODE CHRYSLER C/MACHETA

NEW YORKER, PHANTOM, 90/94

SHADOW, SPIRIT,

STRATUS S/ABS

TODOS TURBO NAL. E IMP.

TRÍPODE FORD C/MACHETA

THUNDERBIRD, COUGAR, GHIA. 88/94

TRÍPODE VOLVO C/MACHETA

VOLVO C-70, V-7 93/97



28211-M1

28 DIENTES 1.178 MED
RT-29295

TRÍPODE GM C/MACHETA

CHEVY 96/98

TRÍPODE CHRYSLER C/MACHETA

NEÓN 95/97



29915-M1

29 DIENTES 1.337 MED

TRÍPODE GM C/MACHETA

CAVALIER 95/02

PONTIAC SUNFIRE y GRAND AM 96/UP



30035-M1

30 DIENTES 1.456 MED

TRÍPODE VW C/MACHETA

GOLF JETTA A4, BEETLE 4 CIL 99/01



30211-M1

30 DIENTES 1.177 MED

TRÍPODE NISSAN C/MACHETA

PLATINA TODOS

TRÍPODE CHRYSLER C/MACHETA

VOYAGER AMERICANA 83/95



TRACCIÓN

TRÍPODE CON MACHETA

TRÍPODE CON MACHETA



30715B-M1

30 DIENTES 1.46 MED

TRÍPODE FORD C/MACHETA
TAURUS 86/93
MERCURY SABLE 86/93



32235-M1

32 DIENTES 1.455 MED

TRÍPODE GM C/MACHETA
CAVALIER 88/90
(RODILLO PLANO)



32715A-M1

32 DIENTES 1.46 MED
CON SEGURO
RT-32715-A-JGO

TRÍPODE CHRYSLER C/MACHETA
CIRRUS, STRATUS 96/99
VOYAGER SPIRIT 91/95
TRÍPODE FORD C/MACHETA
TAURUS, SABLE, WINDSTAR 88/99
THUNDERBIRD, COUGAR 89/97
TRÍPODE MAZDA C/MACHETA 93/99
TRÍPODE NISSAN C/MACHETA
SENTRA, LUCINO 96/98
TSURU III 00/02
TRÍPODE TOYOTA C/MACHETA 92/96



32214A-M1

32 DIENTES

TRÍPODE FORD C/MACHETA
ESCAPE 32X35 32X34 01/12
MISTIQUE CONTOUR 2.5L 95/00
32X26



32335-M1

32 DIENTES 1.614 MED

TRÍPODE FORD C/MACHETA
CONTOUR Y MYSTIQUE 95/99
TRÍPODE HONDA
CIVIC 95/99
(BALERO LOCO)



32715A1-M1

32 DIENTES 1.46 MED
SIN SEGURO
RT-32715-A-JGO

TRÍPODE CHRYSLER C/MACHETA
CIRRUS, STRATUS 96/99
VOYAGER 91/95
TRÍPODE FORD C/MACHETA
TAURUS, SABLE, WINDSTAR 88/99
THUNDERBIRD, COUGAR 89/97
TRÍPODE MAZDA C/MACHETA 93/99
TRÍPODE NISSAN C/MACHETA
SENTRA, LUCINO 96/98
TSURU III 00/02
TRÍPODE TOYOTA C/MACHETA 92/96



32300-M1

32 DIENTES

TRÍPODE VW C/MACHETA
AUDI 05/09
BEETLE 06/09
BORA 32X26 06/10
ACURA RDX 32X29 32X27 07/10



32440-M1

32 DIENTES 1.454 MED

TRÍPODE GM C/MACHETA
CAVALIER 88/94
CENTURY, CUTLASS, 2.8 y 3.7L TODOS



34040-M1

34 DIENTES

1.698 MED

TRÍPODE VW C/MACHETA
SHARAN 1.8L
GOLF-JETTA A4 1.8L
ALHAMBRA

00/07
00/07
00/07



34335-M1

34 DIENTES

1.612 MED

TRÍPODE FORD C/MACHETA
MONDEO AUTOMATICO
TRÍPODE VW C/MACHETA
GOLF-JETTA AUTOMATICO
PASSAT AUTOMATICO VR6
BETTLER VR6 AUTOMATICO

02/07
94/99
00/02
99/07



TUBOS Y MANGUERAS

DESCRIPCIÓN DEL TUBO

TUBOS Y MANGUERAS



TUBOS Y MANGUERAS

- 1.- Tubo de agua
- 2.- Manguera de agua
- 3.- Abrazadera
- 4.- Entrada para Manguera de radiador
- 5.- Sujetador para pija
- 6.- Sujetador para tornillo
- 7.- Sujetador para pija
- 8.- Entrada para Manguera de Calefacción
- 9.-Sujetador para pija
- 10.- Entrada para Manguera de Calefacción
- 11.-Entrada a la calefacción

TUBOS Y MANGUERAS

CHRYSLER:DODGE



TUBOS Y MANGUERAS



5185

TUBO DE ENFRIAMIENTO

NEON 2.0L, 4 CIL	03/05
STRATUS 2.0L, 4 CIL	02/06

No. Original: 04777171AB



511660

Ref.: 11660

TUBO DE ENFRIAMIENTO

NACIONAL Y AMERICANA

VOYAGER y CARAVAN V6 3.0	93/96
--------------------------	-------

No. Original: MD111660



51491AB

Ref.:1491AB

TUBO DE ENFRIAMIENTO

STRATUS 2.4L TURBO	01/09
--------------------	-------

No. Original: 04621491AB



521491

TUBO SALIDA DE AGUA

STRATUS 2.4L ASPIRACIÓN NATURAL 6 CIL	95/00
--	-------

No. Original: 04621491



525265

Ref.: 25265

TUBO DE ENFRIAMIENTO

NACIONAL Y AMERICANA

VOYAGER, CARAVAN y LEBARON V6 3.0L	93/96
---------------------------------------	-------

No. Original: MD125265



525267

Ref.: 25267

MANGUERA CONECTORA PARA TUBO DE AGUA

NACIONAL Y AMERICANA

VOYAGER y CARAVAN V6 3.0L	93/96
---------------------------	-------

No. Original: MD125267



531987

Ref.: 31987

TUBO SALIDA DE AGUA

STRATUS 2.4L ASPIRACIÓN NATURAL 6 CIL	95/00
--	-------

No. Original: MD131987



553840

TUBO DE AGUA

LEBARON, NEW YORKER, VOYAGER V6 3.0L	90/96
---	-------

No. Original: MD153840



581537

Ref.: 81537

TUBO DE ENFRIAMIENTO

VOYAGER 3.3 y 3.8 L, 6 CIL CON SALIDA (BAJO LA BOMBA DE AGUA)	98/UP
---	-------

No. Original: 04781537AC



TUBOS Y MANGUERAS

CHRYSLER / FIAT / FORD

TUBOS Y MANGUERAS



581608

Ref.: 81608

TUBO DE ENFRIAMIENTO

VOYAGER 3.3 y 3.8 L, 6 CIL 98/UP
SIN SALIDA
(BAJO LA BOMBA DE AGUA)

No. Original: 04781608AC



598102

Ref.: 98102

TUBO DE ENFRIAMIENTO

NACIONAL Y AMERICANA

CIRRUS y STRATUS 96/99

No. Original: MD198102

FIAT



451051

TUBO DE ENFRIAMIENTO

PALIO, ESTRADA, SIENA 1.8L, 04/13
4 CIL

No. Original: 51751051

FORD



71326AE

**MANGUERA DEL RADIADOR QUE VA AL
DEPÓSITO DE ANTICONGELANTE**

MONDEO, CONTOUR y 02/07
MYSTIQUE 2.5L, 6 CIL

No. Original: 13M26XAE



74320AF

TUBO DE AGUA

LINCOLN 3.9L, 8 CIL 99/02
TUNDEBIRD 3.9L, 8 CIL 01/02

No. Original: XW4Z-8A520-AF



7663AA

Ref.: 663AA

TUBO CONECTOR DE LA CALEFACCIÓN

WINDSTAR 3.8L, 6 CIL 99/03

No. Original: XF2Z-18663-AA



76818DA

TUBO DE ENFRIAMIENTO

WINDSTAR 3.8L 6 CIL 96/98

No. Original: F68Z-18B402-DA



76882BA

Ref.: 6882BA

**TUBO DE VENTILADORES
(CONECTA CON BOMBA DE AGUA)**

WINDSTAR 95/03
FREESTAR 3.8L, 6 CIL 03/07

No. Original: F68Z-8290-BA



76Z875

Ref.: 6Z875

**MANGUERA DELANTERA AL DEPÓSITO
ANTICONGELANTE**

ESCAPE, FOCUS y RANGER 4 CIL 11/13

No. Original: CV6Z-8075-D

TUBOS Y MANGUERAS

FORD: MERCURY



TUBOS Y MANGUERAS



778290A

Ref.: 0301DQ

TUBO DE ENFRIAMIENTO

RANGER 2.5L, 4 CIL
RANGER 2.3L, 4 CIL
MAZDA B2300 2.3L, 4 CIL

98/02
95/97
95/97

No. Original: F57Z-8290-A



778402E

Ref.: 78402E

TUBO DE CALEFACCIÓN

WINDSTAR 3.8L, 6 CIL

'95

No. Original: F58Z-18B402-E



78290-A

Ref.: 8290-A

TUBO DE ENFRIAMIENTO

TOPAZ MAQ. 140 2.3L
CARBURADO

84/91

No. Original: F037-8290-A

APLICA PARA TOMA DE AGUA 7008

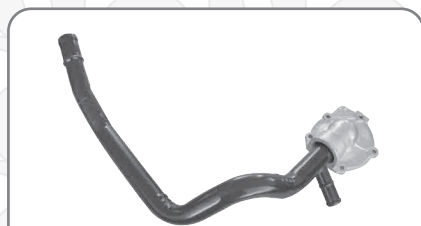

78290-A/7008

Ref.: 8290-A/7008

TUBO DE ENFRIAMIENTO C/BASE DE BOMBA DE AGUA

TOPAZ MAQ. 140 2.3L
CARBURADO

84/91

Ref. 8290A/8508



78290-B

Ref.: 8290-B

TUBO DE ENFRIAMIENTO

GUIA 4 CIL MAQ. 140 2.3L
TOPAZ 4 CIL MAQ. 140 2.3L
FUEL INJECTION

92/94
89/UP

No. Original: F23Z-8290-A

APLICA PARA TOMA DE AGUA 7008

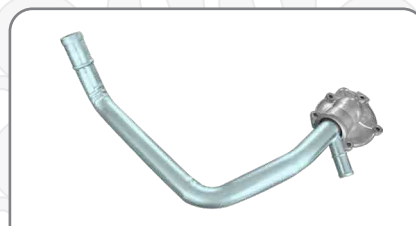

78290-B/7008

Ref.: 8290-B/7008

TUBO DE ENFRIAMIENTO C/BASE DE BOMBA DE AGUA

GUIA 4 CIL MAQ. 140 2.3L
TOPAZ 4 CIL MAQ. 140 2.3L
FUEL INJECTION

92/94
89/UP

Ref: 8290-B/8508

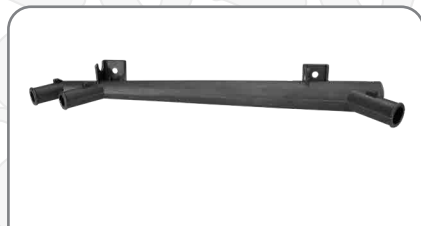

78290-BA

Ref.: 8290-BA

TUBO DE ENFRIAMIENTO SUPERIOR RADIADOR

FOCUS 2.0L, 4 CIL

00/03

No. Original: YS4Z-8290-BA



78290-FI

Ref.: 8290-FI

TUBO DE ENFRIAMIENTO

GUIA 6 CIL MAQ. 3.0L

92/94

No. Original: F23Z-8290-B



78402AC

Ref.: 8402AC

TUBO C/ MANGUERA DE CALEFACCIÓN

WINDSTAR 4.6 L, 6 CIL
(VA DEBAJO DE LA ADMISIÓN)

96/97

No. Original: F6AZ-18B402-AC



TUBOS Y MANGUERAS

FORD: MERCURY

TUBOS Y MANGUERAS



78402 BA

Ref.: 8402 BA

TUBO DE CALEFACCIÓN

MARQUIS 4.6L, 6 CIL

98/00

No. Original: F8AZ-18B402-BA



78548AA

Ref.: 8548AA

TUBO DE ENFRIAMIENTO

WINDSTAR 3.8L, 6 CIL
(SALE DE LA BOMBA DE AGUA)

96/99

No. Original: XF2Z-8548-AA



78579DC

MANGUERA DE CALEFACCIÓN

FIESTA, IKON SEDAN 1.6L, 4 CIL
(CON ENTRADA PARA SENSOR)

01/07

No. Original: 1S61-18K579-DC



78548BC

Ref.: 8548BC

TUBO C/ MANGUERA DE AGUA

WINDSTAR 3.8L, 6 CIL

96/98

No. Original: F68Z-8548-BC



78592CF

Ref.: 8592CF

TUBO DE ENFRIAMIENTO

RANGER ARGENTINA 2.3L, 4 CIL
C/CALEFACCIÓN

01/UP

No. Original: 1L5Z-8592-C F



78663AB

Ref.: 8663AB

TUBO DE ENFRIAMIENTO

LOBO 5.4L, 8 CIL

97/04

No. Original: F75Z-18663-AB



78663BA

Ref.: 8663BA

TUBO DE ENFRIAMIENTO

TRITON B10 6.8 L, 10CIL

99/04

No. Original: F7UZ-18663-BA



7881DD

Ref.: 881DD

**MANGUERA DEPÓSITO
ANTICONGELANTE AL RADIADOR**

FIESTA HATCH/ SEDÁN

02/08

No. Original: 2S65-8B081-DD



76518FB

TUBO DE ENFRIAMIENTO

ECONOLINE 150 4.6L, 5.4L, 8 CIL

80/04

ECONOLINE 250 4.6L, 5.4L, 8 CIL

80/04

EXPEDITION 4.6L, 5.4L, 8 CIL

97/02

F-150, F-250 4.6L, 5.4L, 8 CIL

80/03

LOBO, F-250 4.6L, 5.4L, 8 CIL

2004

No. Original: F65Z-18663-FB

TUBOS Y MANGUERAS

FORD/ GENERAL MOTORS: CHEVROLET-PONTIAC



TUBOS Y MANGUERAS



78521BB

TUBO DE CALEFACCIÓN

SABLE 3.0L 86/08

No. Original: 1F1Z-8A521-BB

GENERAL MOTORS



6078922

Ref.: 078922
TUBO DE CALEFACCIÓN

CAVALIER 3.1L 82/91

No. Original: 10078922



6125944

TUBO DE AGUA

UPLANDER, MONTANA 3.5L 6 CIL 05/06

No. Original: 12594453



6627360

TUBO DE ENFRIAMIENTO

AVEO LXV, PONTIAC G3 LXV 1.6L 4CIL 07/09
AVEO LXT 1.6L 4 CIL 09/18

No. Original: 96273608



615795

Ref.: 15795
TUBO DE ENFRIAMIENTO

CUTLASS 90/94

No. Original: 10115795



618606

Ref.: 18606
TUBO DE ENFRIAMIENTO

CAVALIER, CUTLASS 90/94
Y CENTURY 2.8L, 6 CIL

No. Original: 10118606



6151113

Ref.: 151113
MANGUERA DE BOMBA DE GASOLINA

CHEVY C1, C2, C3, 94/11
CHEVY PICK UP, CHEVY
MONZA 1.6L, 4 CIL

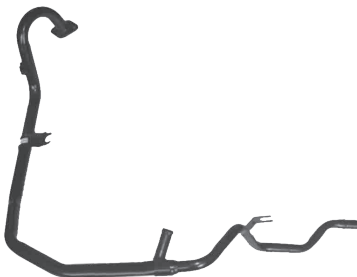

6182364

Ref.: 182364
TUBO DE ENFRIAMIENTO

CAVALIER 2.8L 90/94

No. Original: 10182364



622216

Ref.: 22216
TUBO DE ENFRIAMIENTO

ASTRA 2.0L, 2.2L, 4 CIL 04/06

No. Original: 90322216



TUBOS Y MANGUERAS

GENERAL MOTORS: CHEVROLET-PONTIAC

TUBOS Y MANGUERAS



628719	
Ref.: 28719	
TUBO DE ENFRIAMIENTO	
CORSA 1.4L (ESPAÑOL)	
1.8L (BRASIL)	
MERIVA (TODOS) ASTRA	02/08
TORNADO TURBO <i>S/AIRE</i>	03/05
No. Original: 9128719	



6245029	
Ref.: 245029	
TUBO DE ENTRADA DE AGUA RADIADOR	
CAVALIER 2.2L, 4 CIL	95/05
PONTIAC	
SUNFIRE 2.4L, 4 CIL	95/05
No. Original: 24577029	



630878	
Ref.: 30878	
TUBO DE ENFRIAMIENTO	
TORNADO 1.8L, 4 CIL	11/13
No. Original: 52030878	



631675	
Ref.: 31675	
TUBO DE ENFRIAMIENTO	
ASTRA y ZAFIRA 1.8 y 2.2L	00/05
No. Original: 90531675	



631675-M	
Ref.: 31675-M	
TUBO DE ENFRIAMIENTO DE METAL	
ASTRA y ZAFIRA 1.8 y 2.2L	00/05
No. Original: 90531675	



6317367	
MANGUERA DE CALEFACCIÓN	
ASTRA 2.4L, 4 CIL	04/06
No. Original: 93317367	

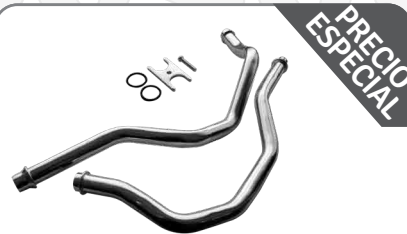

6349824	
TUBOS DE CALEFACCIÓN <i>(SIN AIRE ACONDICIONADO)</i>	
CORSA BRASILEÑO 1.8L, 4 CIL	03/09
MERIVA BRASILEÑA 1.8L	04/09
No. Original: 93349824	



6349827	
TUBOS DE CALEFACCIÓN <i>(CON AIRE ACONDICIONADO)</i>	
CORSA BRASILEÑO 1.8L, 4CIL	03/09
MERIVA BRASILEÑA 1.8L	04/09
No. Original: 93349827	



6339928	
MANGUERA DE RESPIRACIÓN DE VACIO	
TORNADO 1.8L, 4 CIL	11/14
No. Original: 93399285	

TUBOS Y MANGUERAS

GENERAL MOTORS: CHEVROLET-PONTIAC



TUBOS Y MANGUERAS



636975

Ref.: 36975

TUBO DE ENFRIAMIENTO

ASTRA 2.4L, 4 CIL

04/08

No. Original: 93369758



6378094

Ref.: 378094

TUBO TERMOSTATO

CORSA, TORNADO y MERIVA
(2 SALIDAS GRUESAS)

06/UP

No. Original: 93378094



6506264

Ref.: 506264

TUBO DE ENFRIAMIENTO

MALIBÚ 3.1L y 3.4L. 6 CIL
GRAND AM 3.1L y 3.4L. 6 CIL

97/03
99/05

No. Original: 24506264



6383625

Ref.: 383625

**TUBO CONECTOR DE PASO DE AGUA
MÚLTIPLE ADMISIÓN**

CORSA SEDÁN Y TORNADO
1.8L, 4 CIL

03/10

No. Original: 93383625



6399621

**MANGUERA DE RESPIRACIÓN DE VACIO DE
JAULA DEL ÁRBOL DE LEVAS HACIA
ABAJO DEL MONOBLOCK**

CHEVY
CORSA 1.6L, 4 CIL

TODOS
-/06

No. Original: 93399621



648853

Ref.: 48853

TUBO DE ENFRIAMIENTO

CHEVY ESPAÑOL (IMPORTADO)
(2 SALIDAS GRUESAS Y 1 TIPO PIPA)

94/98

No. Original: 90448853

APLICA PARA TOMA DE AGUA 6521356-M



648853-M

Ref.: 48853-M

TUBO DE ENFRIAMIENTO

CHEVY ESPAÑOL (IMPORTADO)
(2 SALIDAS GRUESAS Y 1 TIPO PIPA CON
MANGUERA Y ABRAZADERA)

94/98

No. Original: 90448853



648854

Ref.: 48854

TUBO DE ENFRIAMIENTO

CHEVY 1.4L y 1.6L, 4 CIL
(2 SALIDAS GRUESAS)

96/07

No. Original: 90448854

APLICA PARA MANGUERA 6521356



648854-M

Ref.: 48854-M

TUBO DE ENFRIAMIENTO

CHEVY 1.4L y 1.6L, 4 CIL
(2 SALIDAS GRUESAS
CON MANGUERA Y ABRAZADERA)

96/07

No. Original: 93227142



TUBOS Y MANGUERAS

GENERAL MOTORS: CHEVROLET-PONTIAC

TUBOS Y MANGUERAS



6503423

Ref.: 503423

TUBO DE ENFRIAMIENTO

PONTIAC BONNEVILLE	94/99
IMPALA	00/05
CAMARO 8CIL	93/03

No. Original: 25503423



6565082

Ref.: 565082

TUBO CONECTOR TERMOSTATO

PONTIAC BONNEVILLE	94/99
IMPALA	00/05
CAMARO 8CIL	93/03

No. Original: 12565082



62382-KIT

Ref.: 2382-KIT

TUBO CONECTOR TERMOSTATO

PONTIAC BONNEVILLE	94/99
IMPALA	00/05
CAMARO 8CIL	93/03

No. Original: 25503423 y 12565082



6900915

ASTRA, ZAFIRA 1.4L, 1.6L, 1.8L, 2.0L y 2.4L, 4 CIL	00/07
CHEVY 1.4L, 1.6L, 1.8L, 2.0L y 2.4L, 4 CIL	94/16
CORSA 1.4L, 1.6L, 1.8L, 2.0L y 2.4L, 4 CIL	02/09
MERIVA 1.4L, 1.6L, 1.8L, 2.0L y 2.4L, 4 CIL	03/09
TORNADO 1.4L, 1.6L, 1.8L, 2.0L y 2.4L, 4 CIL	04/09

TUBO DE ENTRADA DE LA BOMBA DE AGUA (PARTE TRASERA DE MONOBLOCK)

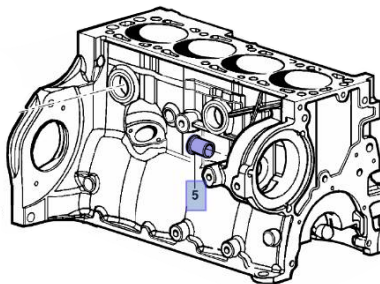

No. Original: 90091526

CONECTA CON TUBO 648854-M Y MANGUERA 6521356



6520308

MANGUERA DE CALEFACCIÓN

TORNADO 1.8L, 4 CIL	11/14
---------------------	-------

No. Original: 52030883



6521356

MANGUERA PARA TUBO DE ENFRIAMIENTO

REF.: 521356

CHEVY 1.4L y 1.6L	96/07
-------------------	-------

No. Original: 93327384

APLICA PARA TUBO 48854

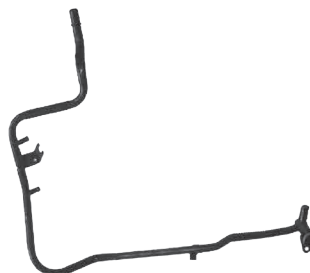

6568001

Ref.: 568001

TUBO TERMOSTATO

MALIBÚ 3.1L	97/04
-------------	-------

No. Original: 12568001



6574380

Ref.: 574380

TUBO DE RADIADOR "APLASTADO"

CAVALIER 2.4L	95/02
MALIBÚ	97/04
PONTIAC SUNFIRE 2.4L	97/02

No. Original: 24574380

TUBOS Y MANGUERAS

GENERAL MOTORS/HONDA



TUBOS Y MANGUERAS



6590279

Ref.: 590279

TUBO DE ENFRIAMIENTO

MALIBU	97/03
LUMINA	90/96
VENTURE 3.1L y 3.4L, 6 CIL	97/05

No. Original: 12590279



6928861

Ref.: 928861

TUBO DE CALEFACCIÓN

CORSA L4 1.4L VEHICULOS (C/AIRE ACONDICIONADO)	02/05
--	-------

No. Original: 93288618



6961835

Ref.: 961835

TUBO DE CALEFACCIÓN

AVEO L4 1.6L	07/09
PONTIAC G3 L4 1.6L	

No. Original: 96180035



6933781

MANGUERA DE CALEFACCIÓN

CORSA, MERIVA y TORNADO 1.8L, 4 CIL	06/UP
-------------------------------------	-------

No. Original: 93378100



692021-1

Ref.: 92021-1

TUBO DE ENFRIAMIENTO

ASTRA 1.8L, 4CIL	05/12
------------------	-------

No. Original: 9202151

HONDA



91950C

TUBO DE ENFRIAMIENTO

CIVIC 1.7L, 4 CIL	01/05
-------------------	-------

No. Original: 19505-PLC-000



95058A

TUBO DE ENFRIAMIENTO

ACCORD 3.0L, 6 CIL	98/02
--------------------	-------

No. Original: 19505-P8A-A00



99505P

TUBO DE ENFRIAMIENTO

ACCORD 2.2L, 4 CIL	94/97
--------------------	-------

No. Original: 19505-P0A-000

HYUNDAI



922756

Ref.: 22756

TUBO DE ENFRIAMIENTO

ATOS 1.1L, 4 CIL	06/UP
------------------	-------

No. Original: 2563202756

APLICA PARA T/A 9512 Y MANGUERA 925630



TUBOS Y MANGUERAS

HYUNDAI /MAZDA/ NISSAN

TUBOS Y MANGUERAS



925630

MANGUERA

ATOS 1.1L, 4 CIL (CON 2 ABRAZADERAS) 06/UP

No. Original: 25630-02550

APLICA PARA T/A 9512 Y PARA TUBOS 922756-1 Y 922756



925461

TUBO CALEFACCIÓN

H-100 GASOLINA 2.4L, 4 CIL 04/UP

No. Original: 25461-43900



946026

TUBO CALEFACCIÓN

VERNA DOBLE ÁRBOL 1.5L, 4 CIL TODOS

No. Original: 25460-26000



954612

TUBO CALEFACCIÓN

VERNA ÁRBOL SENCILLO 1.5L, 4 CIL TODOS

No. Original: 25461-22601

MAZDA



93612XH

CONECTOR DE CALEFACCIÓN

MAZDA 6 3.0L, 6 CIL 03/08

No. Original: GK3K6124XH

NISSAN



900QAB

Ref.: 00QAB

TUBO DE ENFRIAMIENTO

PLATINA 1.6L, 4 CIL TODOS

No. Original: 14875-00QAB



914055

Ref.: 14055

MANGUERA PARA AGUA

TSURU III B13 1.6L, 4 CIL TODOS

No. Original: 14055-F4121

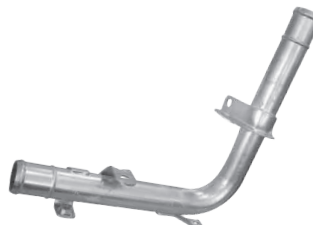

921021

Ref.: 21021

TUBO DE ENFRIAMIENTO

TSURU III B13 16V, 4 CIL 93/96

No. Original: 21021-F4100



921022

Ref.: 21022

TUBO DE ENFRIAMIENTO

TSURU III B13 16V, 4 CIL 97/Up

No. Original: 21021-F420B

TUBOS Y MANGUERAS

NISSAN

TUBOS Y MANGUERAS



921047

Ref.: 21047
MANGUERA DE AGUA

TSURU III B13 (ESTAFETA) 1.6L, 4 CIL	98/UP
---	-------

No. Original: 21047-F4300



921501

Ref.: 21501
MANGUERA PARA RADIADOR SUPERIOR

TSURU III B13 1.6L, 4 CIL	98/Up
---------------------------	-------

No. Original: 21501-F4200



921503

Ref.: 21503
MANGUERA PARA RADIADOR INFERIOR

TSURU III B13 1.6L, 4 CIL	98/UP
---------------------------	-------

No. Original: 21503-F4200



930520

Ref.: 30520
PALANCA DE EMBRAGUE

TSURU III B13 1.3L, 4 CIL	92/UP
---------------------------	-------

No. Original: 30520-F4200



940554

Ref.: 40554
MANGUERA DE AGUA

TSURU III B13 1.6L, 4 CIL	98/UP
---------------------------	-------

No. Original: 14055-F4303



944000-1

MANGUERA

PICK UP D21 2.4L, 4 CIL	03/07
-------------------------	-------

No. Original: 14055-F4000



944100-1

MANGUERA

TSUBAME 1.8L, 4 CIL	02/06
---------------------	-------

No. Original: 14055-F4100



944102-1

MANGUERA

TSUBAME 1.8L, 4 CIL	02/06
---------------------	-------

No. Original: 14055-F4102



944300

MANGUERA DE RESPIRACIÓN DEL CUERPO DE ACCELERACIÓN

TSURU III B13 1.8L, 4 CIL	03/UP
---------------------------	-------

No. Original: 14055-F4300



TUBOS Y MANGUERAS

NISSAN

TUBOS Y MANGUERAS



944301

MANGUERA QUE VA AL DEPOSITO DE DIRECCIÓN HIDRÁULICA

TSURU III B13 1.8L, 4 CIL

03/UP

No. Original: 14055-F4301



941405

MANGUERA QUE VA DEL TUBO DE AGUA A LA BOMBA DE AGUA

PICK UP D21 y D22 2.4L, 4 CIL

03/07

No. Original: 14056-F4000



944003-1

MANGUERA QUE VA DEL TUBO DE AGUA A LA BOMBA DE AGUA

PICK UP D21 Y D22 2.4L, 4 CIL

08/15

No. Original: 14056-F4003



945641-1

MANGUERA

TSUBAME 1.8L, 4 CIL

92/16

No. Original: 14056-F4100



941826-1

MANGUERA

TSUBAME 1.8L, 4 CIL

92/16

No. Original: 11826-F4100



946430-1

MANGUERA DE RESPIRACIÓN DE ACEITE QUE CONECTA AL MULTIPLE DE ESCAPE

TSURU III B13 1.8L, 4 CIL

92/16

No. Original: 11826-F4304



941182

MANGUERA DE RESPIRACIÓN DE ACEITE QUE CONECTA A LA TAPA DE PUNTERIAS

TSURU III B13 1.8L, 4 CIL

92/16

No. Original: 11826-F4305



942400

MANGUERA QUE VA AL AIRE ACONDICIONADO

D21 2.4L, 4 CIL

92/16

No. Original: 92400-F4001



944200

MANGUERA

TSURU III B13 1.8L, 4 CIL

92/16

No. Original: 11826-F4200

TUBOS Y MANGUERAS

NISSAN



TUBOS Y MANGUERAS

NUEVO



944200

MANGUERA

TSURU III B13 1.8L, 4 CIL	92/16
---------------------------	-------

No. Original: 11826-F4200

NUEVO



948264

MANGUERA

TSURU III B13 1.8L, 4 CIL	92/16
---------------------------	-------

No. Original: 11826-F4300

NUEVO



944303

MANGUERA DE RESPIRACIÓN DE LA TAPA DE PUNTERIAS AL FILTRO DE AIRE

TSURU III B13 1.8L, 4 CIL	92/16
---------------------------	-------

No. Original: 11826-F4303



944065

MANGUERA SUPERIOR

SENTRA-B15 1.8L, 4 CIL	01/06
------------------------	-------

No. Original: 92400-6Z500



944057

MANGUERA DE CALEFACCIÓN

PICK UP D21 2.4L, 4 CIL	95/07
-------------------------	-------

No. Original: 92400-57G05, 92400-86G00



942410-1

MANGUERA QUE VA DEL DEPÓSITO DE DIRECCIÓN HIDRÁULICA A LA BOMBA DE DIRECCIÓN

D21 2.4L, 4 CIL	03/07
-----------------	-------

No. Original: 92410-F4001



942450-1

MANGUERA INFERIOR

SENTRA-B15 1.8L, 4 CIL	01/06
------------------------	-------

No. Original: 92410-6Z500



954305

Ref.: 54305
MANGUERA PARA AGUA

TSURU III B13 1.6L, 4 CIL	98/UP
---------------------------	-------

No. Original: 14055-F4305



955430

Ref.: 55430
MANGUERA PARA AGUA

TSURU III B13 1.6L, 4 CIL	98/UP
---------------------------	-------

No. Original: 14055-F4304



TUBOS Y MANGUERAS

NISSAN/RENAULT/TOYOTA/VOLKSWAGEN

TUBOS Y MANGUERAS



992400

Ref.: 92400
MANGUERA DE CALEFACCIÓN SUPERIOR

TSURU III B13 1.6L, 4 CIL 98/UP

No. Original: 92400-F4203



992410

Ref.: 92410
MANGUERA DE CALEFACCIÓN INFERIOR

TSURU III B13 1.6L, 4 CIL 98/UP

No. Original: 92410-F4202

RENAULT



900QAB

Ref.: 00QAB
TUBO DE ENFRIAMIENTO

CLIO 1.6L, 4 CIL TODOS

No. Original: 14875-00QAB

TOYOTA



975130

TUBO DE AGUA

HIACE 2.7L, 4 CIL 05/UP

No. Original: 16268-75130

VOLKSWAGEN



1065A

Ref.: 065A
TUBO DE ENFRIAMIENTO

POINTER 1.8L, 4 CIL 00/09
(SIN AIRE ACONDICIONADO)

No. Original: 377-121-065-AA



1065-H

Ref.: 065-H
TUBO DE ENFRIAMIENTO

POINTER 1.8L, 4 CIL 00/09
CON AIRE ACONDICIONADO

No. Original: 377-121-065-H



1065-J

Ref.: 065-J
TUBO DE ENFRIAMIENTO

POINTER 1.8L, 4 CIL 00/09
C/AIRE ACONDICIONADO

No. Original: 377-121-065-J



1221-AN

MANGUERA

JETTA CLÁSICO A4, A5, 00/10
BICENTENARIO 1.8L, 4 CIL
TURBO

No. Original: 06A-103-221-AN



11065D

Ref.:1065D
TUBO DE ENFRIAMIENTO

A2 88/92

No. Original: 027-121-065-D

TUBOS Y MANGUERAS

VOLKSWAGEN



TUBOS Y MANGUERAS



1065-AK

Ref.: 065-AK
TUBO DE ENFRIAMIENTO

A4 1.8L, 4 CIL *STANDARD* 00/05

No. Original: 06A-121-065-AK

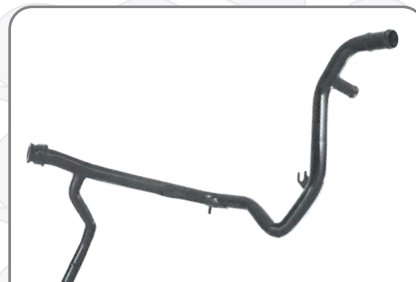

1065-AR

Ref.: 065-AR
TUBO DE ENFRIAMIENTO

JETTA A4 2.0L, 4 CIL *AUTOMÁTICO* 00/15

No. Original: 06A-121-065-AR



1065-CA

Ref.: 065-CA
TUBO DE ENFRIAMIENTO

JETTA A4 *NORMAL* 2.0 L, 4 CIL 00/15

No. Original: 06A-121-065-CA



11087-LG

Ref.: 1087-LG
REPARTIDOR DE AGUA

BORA 02/UP

No. Original: 1K0-121-087-LG

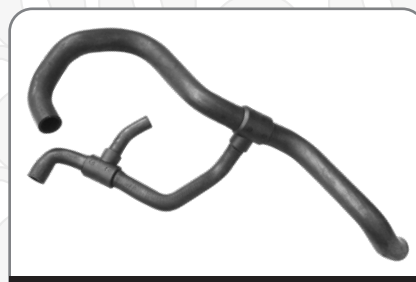

1211101

Ref.: 121101
**MANGUERA DE RADIADOR
"PULPO" BOMBA DE AGUA**

GOLF y JETTA A3
1.8 y 2.0L, 4 CIL 93/99

No. Original: 1HM-121-101



1213-A

Ref.: 213-A
MANGUERA DE RESPIRACIÓN

JETTA, BEETLE, GOLF TURBO
1.8L, 4 CIL 00/07

No. Original: 06A-103-213-F



1213-BG

Ref.: 213-BG
TUBO DE RESPIRACIÓN DE ACEITE

JETTA A4 TURBO
1.8L, 4 CIL 99/05

No. Original: 06A-103-213-BG



1213-F

Ref.: 213-F
TUBO CODO DE RESPIRO DE ACEITE

JETTA A4, NEW BEETLE, PASSAT,
AUDI A4, 1.8L, 4 CIL TURBO. 00/05

No. Original: 06A-103-213-F



1240-A

Ref.:240-A
MANGUERA FILTRO-TAPA PUNTERÍAS

JETTA CLÁSICO, A4, NEW
BEETLE, GOLF 4 CIL
MOTOR AEG 2.0L 00/05

No. Original: 06A-133-240



TUBOS Y MANGUERAS

VOLKSWAGEN

TUBOS Y MANGUERAS



1349-A

MANGUERA PARA FILTRO DE AIRE - TAPA DE PUNTERIAS

GOLF, JETTA A3, DERBY 1.8L, 4 CIL 93/99

No. Original: 1HM-109-493-A



1447DM

Ref.: 447DM

MANGUERA DE RADIADOR "PULPO"

GOLF y JETTA A4 99/UP

No. Original: 1J0-122-477-DM



1447DM-C

CONECTOR PARA MANGUERA DE RADIADOR "PULPO"

GOLF y JETTA A4 99/UP

No. Original: 1J0-122-477-DM



1493-A

Ref.:493-A

MANGUERA DE FILTRO DE AIRE FORMA DE "T"

JETTA A3 1.8L, 4 CIL 93/98

No. Original: 048-103-493-A



1493-AC

MANGUERA DE AIRE

JETTA CLÁSICO 2.0L, 4 CIL 04/UP
MOTOR. PHP

No. Original: 06A-103-493-AC



1296-AD

MANGUERA P/ FILTRO DE AIRE

A4, NEW BEETLE 2.0L, 4 CIL 03/08

No. Original: 1J0-129-684-AD,
1J0-129-684-CK



1615-F

MANGUERA P/ FILTRO DE AIRE

POINTER 1.8L 4 CIL 04/UP

No. Original: 377-129-615-F



1684-J

MANGUERA P/ FILTRO DE AIRE

DERBY 1.8L, 4 CIL 00/02
IBIZA, CORDOBA 1.8L, 4 CIL 99/02

No. Original: 6K0-129-684-J



1065-D

Ref.: 065-D

TUBO DE ENFRIAMIENTO

POLO, LUPO y CROSS FOX 00/07
2.0L

No. Original: 032-121-065-D

TUBOS Y MANGUERAS

VOLKSWAGEN



TUBOS Y MANGUERAS

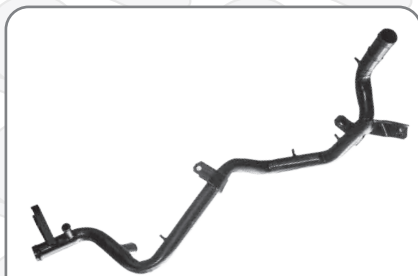

11065K

Ref.: 1065K

TUBO DE ENFRIAMIENTO

A3 1.8L DERBY

95/02

No. Original: 037-121-065-K

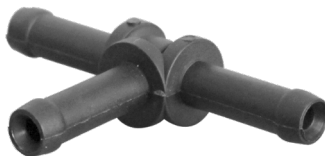

1737-A

CONECTOR (COPLÉ)

BORA 2.0L, 4 CIL
 BEETLE 2.0L, 4 CIL
 CLÁSICO 2.0L, 4 CIL
 GOLF 2.0L, 4 CIL
 SHARAN 2.0L, 4 CIL
 DERBY 2.0L, 4 CIL
 TRANSPORTER (EUROVAN)
 2.0L, 4 CIL

05/10
 98/05
 87/01
 99/07
 01/08
 95/97
 00/10

No. Original: 2D0-129-737-A



11050C

Ref.: 1050C

TUBO DE ENFRIAMIENTO

A3 VR6

97/02

No. Original: 021-121-050-C

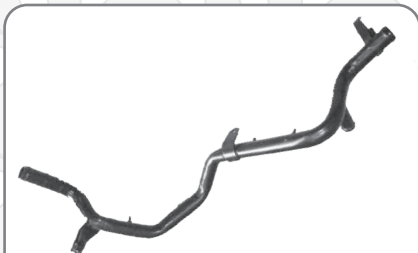

11065L

Ref.: 1065L

TUBO DE ENFRIAMIENTO

A3 2.0L DERBY

97/02

No. Original: 037-121-065-L

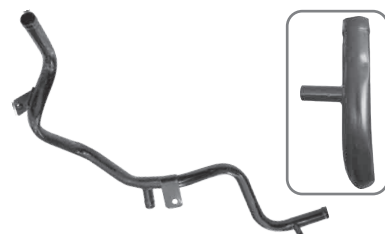

11065M

Ref.: 1065M

TUBO DE AGUA GRUESO

GOLF, JETTA A1, A2, CARIBE,
 ATLANTIC A1, A2
 COMBI T2A 1.8L, 4 CIL

88/89

92/UP

No. Original: 1009-5485

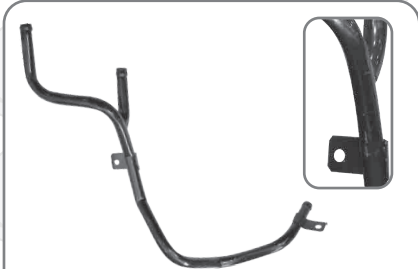

11065N

Ref.:1065N

TUBO DE AGUA

CARIBE M.1600;
 ATLANTIC A1 1.6L, 4 CIL

77/87

No. Original: 1009-1625

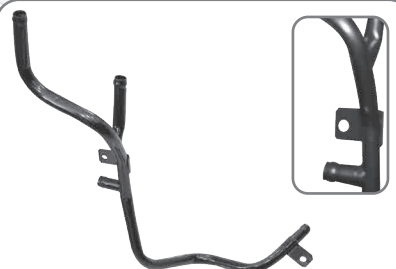

11065P

Ref.:1065P

TUBO DE AGUA

CARIBE M.1700;
 ATLANTIC A1 1.7L, 4 CIL

85/87

No. Original: 1009-0565

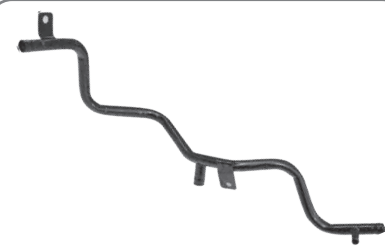

11065Q

Ref.: 1065Q

TUBO DE AGUA DELGADO

CARIBE M. 1800, GOLF JETTA
 COMBI 1800 1.8L, 4 CIL

88/99

92/UP

No. Original: 1009-2038



TUBOS Y MANGUERAS

VOLKSWAGEN

TUBOS Y MANGUERAS



1065R

TUBO DE ENFRIAMIENTO

GOLF, JETTA A2 1.8L, 4 CIL 87/92

No. Original: 027-121-065-K



1210-K

TUBO DE ENFRIAMIENTO

VENTO 1.6L, 4 CIL 15/UP

No. Original: 03C-121-065-K



1065-DE-1

TUBO DE AGUA

JETTA CLÁSICO 2.0L 11/15

No. Original: 06A-121-065-DE



1065-DE-M

TUBO DE AGUA/ METAL

JETTA CLÁSICO 2.0L 11/15

No. Original: 06A-121-065-DE



1188-B

TUBO DE AGUA

VENTO TODOS

No. Original: 036-121-188-B



186434

COPLE UNIVERSAL CON ENTRADA PARA SENSOR TODOS

No. Original:



FORD



V-7495A

Ref.: V-495A
CALEFACCIÓN

EXPLORER 4.0L, 6 CIL
RANGER AMERICANO

99/10
96/02

No. Original: F87Z-18495-AA

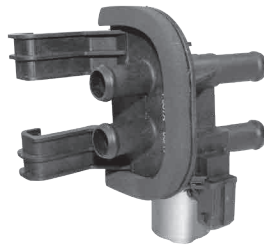

V-78495

Ref.: V-8495
CALEFACCIÓN

KA y COURIER, FIESTA HATCH
y SEDÁN, IKON 1.6L, 4 CIL
FIESTA (ALIMENTACIÓN DE AIRE)

04/UP

No. Original: 7N21-18495-AC

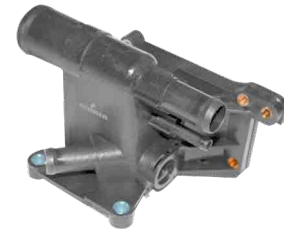

V-78556

Ref.: V-8556
CALEFACCIÓN

ECOSPORT 2.0L, 4 CIL

TODOS

No. Original: 8K55-68K55-A

GM



V-63062

Ref.: V-3062
CALEFACCIÓN

MERIVA 1.8L, 4 CIL

03/09

No. Original: 93306264



V-65536

Ref.: V-5536
ALIMENTACIÓN CALENTADOR

CHEVY C2
CORSA y TORNADO 1.8L,
1.6L 4 CIL

01/07

No. Original: 93275536



V-68318

CALEFACCIÓN

PICK UP SILVERADO, 1500,
2500 & 3500, SUBURBAN
y SONORA 5.7L, 8 CIL

92/00

No. Original: 12380318



V-66715-1

Ref.: V-6715-1
CALEFACCIÓN

CHEVY 1.6L, 4 CIL

09/12

No. Original: 94671517



V-66947

Ref.: V-6947
CALEFACCIÓN

CHEVY C1 1.3L y 1.4, 4 CIL
(3 SALIDAS)

94/08

No. Original: 90566947



V-69686

Ref.: V-9686
CONTROL CIRCULACIÓN DE AIRE CALIENTE

CHEVY
CORSA 1.8L, 4 CIL

00/07

No. Original: 93369686



VÁLVULAS

GENERAL MOTORS/ VOLKSWAGEN

VÁLVULAS



PRECIO ESPECIAL

6349824

**TUBOS DE CALEFACCIÓN
(SIN AIRE ACONDICIONADO)**

CORSA BRASILEÑO 1.8L, 4 CIL 03/09
MERIVA BRASILEÑA 1.8L 04/09

No. Original: 93349824



PRECIO ESPECIAL

6349827

**TUBOS DE CALEFACCIÓN
(CON AIRE ACONDICIONADO)**

CORSA BRASILEÑO 1.8L, 4CIL 03/09
MERIVA BRASILEÑA 1.8L 04/09

No. Original: 93349827

VOLKSWAGEN



V-11011

Ref.: V-1011

**FILTRO AIRE TAPA REGULADORA
DE PRESIÓN**

POINTER 1.8L, 2.0L 96/09

No. Original: 327-129-101-1



V-1101A

Ref.: V-101A

FILTRO AIRE TAPA PUNTERIAS

A4 2.0L 99/15

No. Original: 06A-129-101-A



V-1101K

Ref.: V-101K

**FILTRO AIRE TAPA REGULADORA
DE PRESIÓN**

A3 DERBY 93/99

No. Original: 037-129-101-K



V-13465

Ref.: V-3465

ANTI FUEGO

JETTA A4, NEW BEETLE, 00/05
IBIZA (BOCA DE RELLENO)
2.0L, 4 CIL

No. Original: 06A-103-465



CHRYSLER



0178

SOPORTE DE BALANCÍN

RAMBLER, JEEP y WAGONEER 72/UP

No. Original: 3210178



7557

PORTA RETÉN DE COJINETE

CHRYSLER 6 CIL MOTOR 225
AUTOS
CAMIONETAS

TODOS
60/82
60/UP

No. Original: 1947557, 4390543

GM



8500

SOPORTE DE MOTOR

CAVALIER V-6 87/93

No. Original: 22538500
Ref. 1909



9581

SOPORTE DE MOTOR

CELEBRITY, CITATION,
CENTURY, CUTLAS V6 82/92

No. Original: 22112737 Ref. 1864

NISSAN

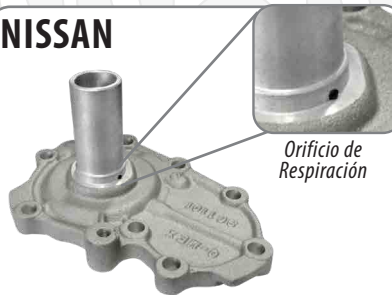

Orificio de
Respiración

9C1101

CANDELERO DE TRANSMISIÓN

URVAN 2.5L 4 CIL 07/14

No. Original: 32111-MA01A

VER ESQUEMA PÁG. 243

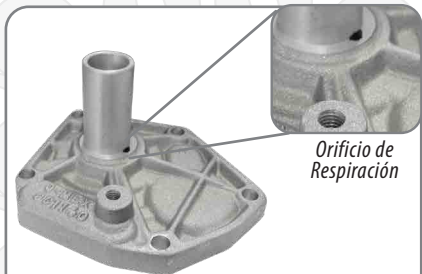

Orificio de
Respiración

9C1140

CANDELERO DE TRANSMISIÓN

PICK UP D21, D22 2.4L, 4 CIL 95/15
(12 y 16 VÁLVULAS) URVAN 2.4L

No. Original: 32111-F4000

VER ESQUEMA PÁG. 243

VOLKSWAGEN



100-M

MARIPOSA CHICOTE CLUTCH
(GALVANIZADA)

SEDAN y COMBIT2 y T2A TODOS

No. Original: 131-721-349



100-M-E

MARIPOSA CHICOTE CLUTCH
(SIN GALVANIZAR)

SEDAN y COMBIT2 Y T2A TODOS

No. Original: 131-721-349



1225

RETÉN DE CAMAPANA DE CAJA DE VELOCIDADES (TIPO ORIGINAL)

SEDAN 1500-1600 58/03

No. Original: 080-301-225-2



VARIOS

VARIOS

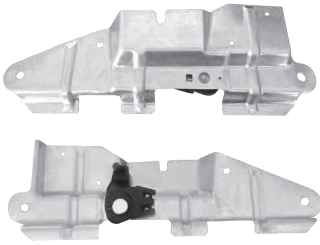

17567-A

**CHAPA PORTANTE (ACCIONAMIENTO)
CAJUELA.**

JETTA CLÁSICO 99/UP

No. Original: 1J5-827-425-F
1J5-827-567-A



211-G

**CAMPANA DE CAJA DE VELOCIDADES
(TIPO ORIGINAL)**

SEDAN 1500-1600 58/03
CON RETEN

No. Original: 080-301-211-G

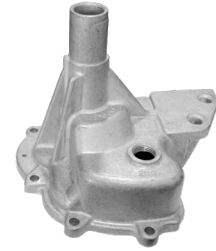

211-G/S

**CAMPANA DE CAJA DE VELOCIDADES
(TIPO ORIGINAL)**

SEDAN 1500-1600 58/03
SIN RETEN

No. Original: 080-301-211-G



NUEVO

205-H

CAMPANA DE CAJA DE VELOCIDADES

VW SEDAN1600 59/67
CON RETEN

No. Original: 211-301-205-H



C-243

SOPORTE DE TRANSMISIÓN

COMBIT2 1600 70/87

No. Original: 211-599-243-B



AS-12

**AUMENTO PARA RESORTE DE
SUSPENSIÓN**

MUELA CHICA



NUEVO

69049

PEDAL

GM- CHEVY 94/12
TODOS MODELOS



NUEVO

64271

PEDAL (HIDRAÚLICO Y DE CHICOTE)

SPARK 10/18

ESQUEMA CANDELERO TRANSMISIÓN

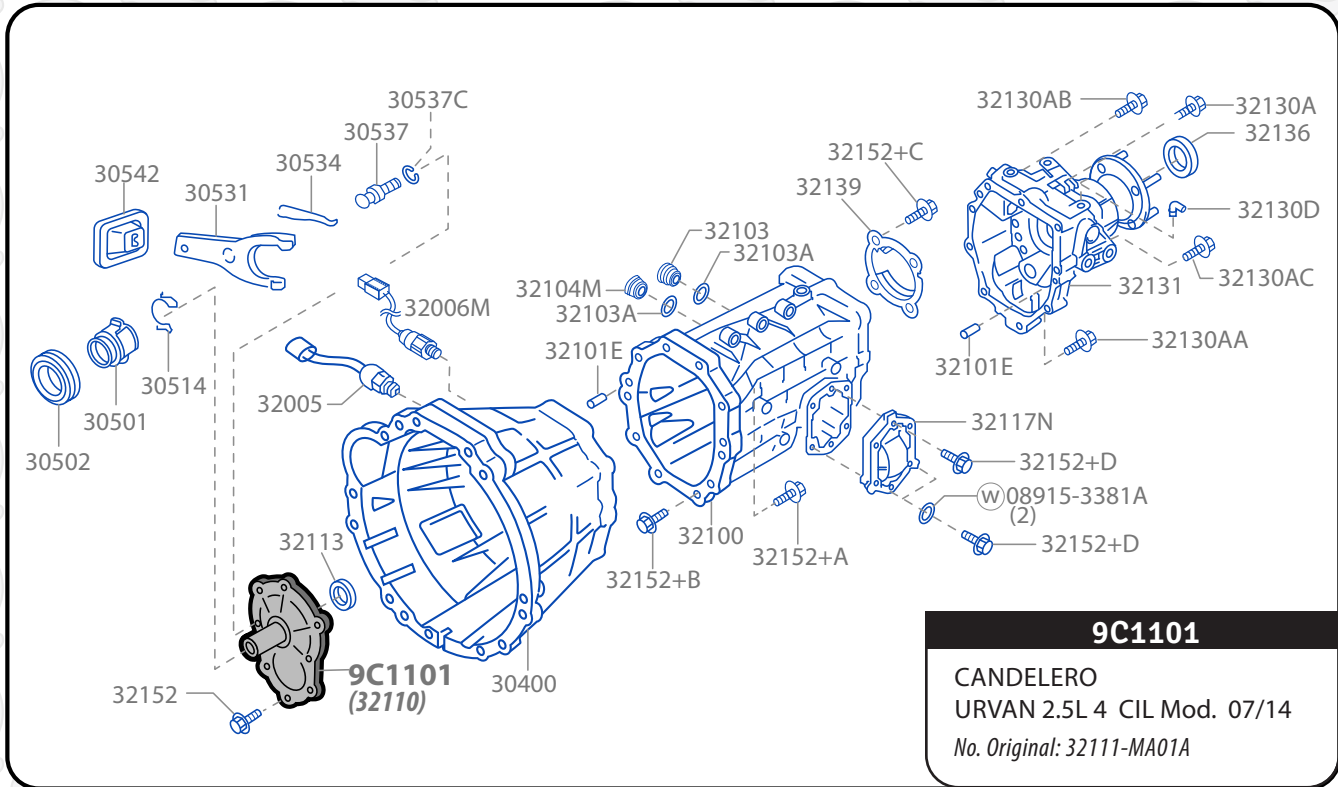

9C1101
CANDELERO
 URVAN 2.5L 4 CIL Mod. 07/14
 No. Original: 32111-MA01A

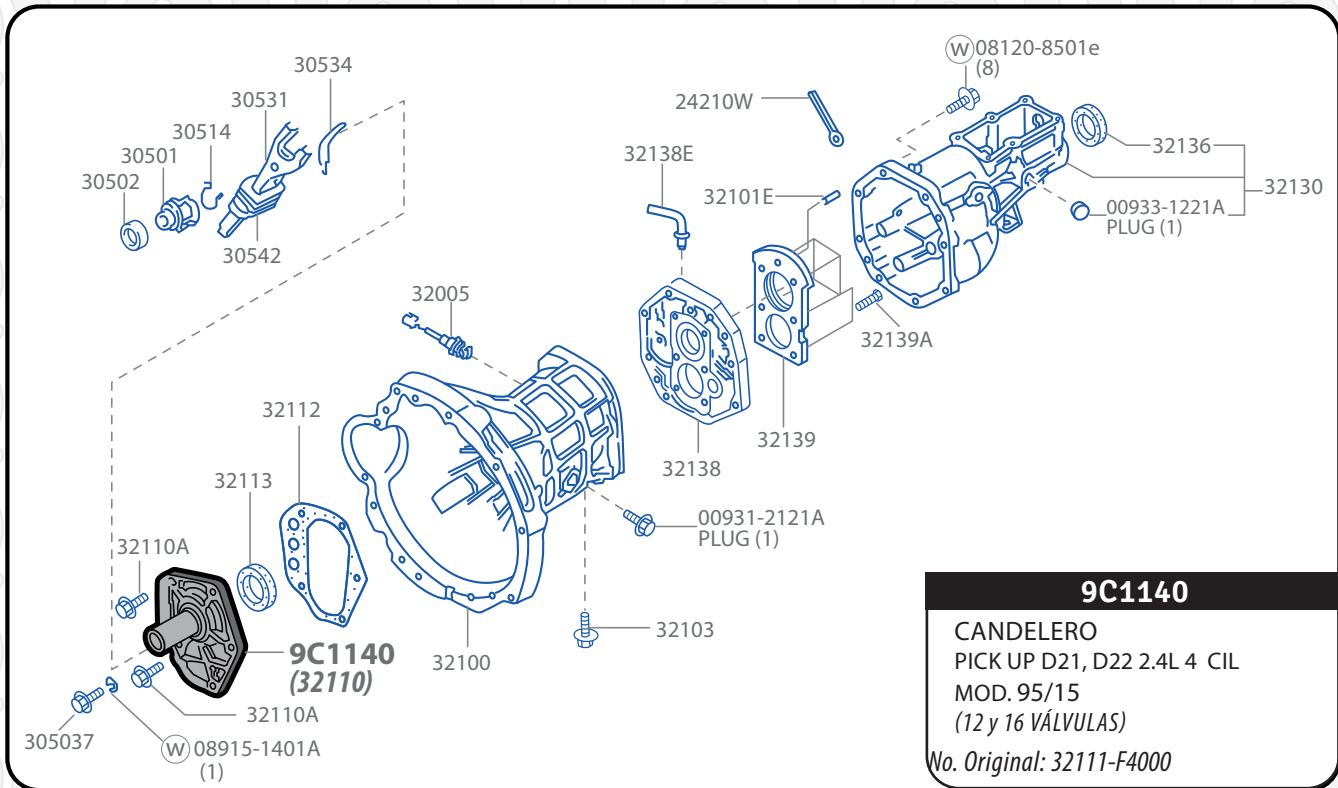

9C1140
CANDELERO
 PICK UP D21, D22 2.4L 4 CIL
 MOD. 95/15
 (12 y 16 VÁLVULAS)
 No. Original: 32111-F4000



MAQUILAS

GRADUADOR DE BUJÍAS/LLAVEROS

MAQUILAS/ GRADUADOR DE BUJÍAS

**GRADUADOR "MONEDA" (3.7cm) LOGOTIPO QUEZADA
CON BORDE AFILADO TIPO RAMPA PARA BUJÍAS
MEDIDAS EN PULGADAS Y MILIMETROS**



GB-01-G

**GRADUADOR DE BUJÍAS
GALVANIZADO (AZUL)**



GB-02-N

**GRADUADOR DE BUJÍAS
NIQUELADO**



FRENTE



REVERSO



**GRADUADOR DE BUJIAS
PERSONALIZADO*
CON LOGOTIPO**



1 CARA

***MÍNIMO 1000 PIEZAS**

1.7cm x 1cm

**LLAVERO PERSONALIZADO
EN UNA O AMBAS CARAS
INYECTADO EN ALUMINIO****



1 Cavidad

**PERSONALIZABLE 1 CARA
REVERSO C/LOGO Quezada**



2 Cavidades

PERSONALIZABLE 2 CARAS

****4 CM DE DIÁMETRO**

O bien, solicita los llaveros de
GRUPO QUEZADA:

- **LL-CIQSA**
- **LL-AESA**
- **LL-AMASA**



MARCO PORTA PLACA DE PLÁSTICO / NEGRO LISO



MARCO PORTA PLACA DE PLÁSTICO NEGRO PERSONALIZADO A 1 O 2 TINTAS



PERSONALIZADO

501-P-S-L-1 (1 tinta)

501-P-S-L-2 (2 tintas)

CON TELÉFONO y/o PÁGINA WEB

Políticas de venta:

Cantidad Mínima: 50 juegos x modelo.

Cada juego contiene 2 pzas iguales
(Teléfono o Página Web).

La mercancía se entrega en bolsa sellada.

MARCO PORTA PLACA CON RELIEVE PERSONALIZADO*



PLÁSTICO/ NEGRO/ OJAL LARGO
RELIEVE+ SERIGRAFIA o HOT STAMPING

*MINIMO 250 JUEGOS= 500 PIEZAS

MARCO PORTA PLACA PREMIUM METÁLICO(Zamak) C/2 TAPONES P/TORNILLOS NEGRO



MARCO PORTA PLACA PREMIUM METÁLICO(Zamak) C/2 TAPONES P/TORNILLOS CROMADO



(**VENTA POR PIEZA)



MAQUILAS

EMBUDO MULTIUSOS PERSONALIZADO

MAQUILAS/ EMBUDOS

EMBUDO MULTIUSOS



*Parte Superior:
Ideal para aceite
de motor*



*Flexible para cualquier
situación*

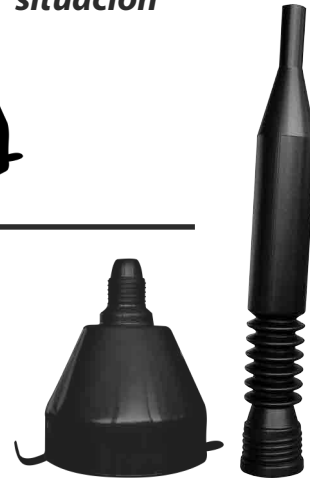

*¡Piezas independientes
que enroscan perfectamente!*

*Ideal para aceite de transmisión
hidráulica.*

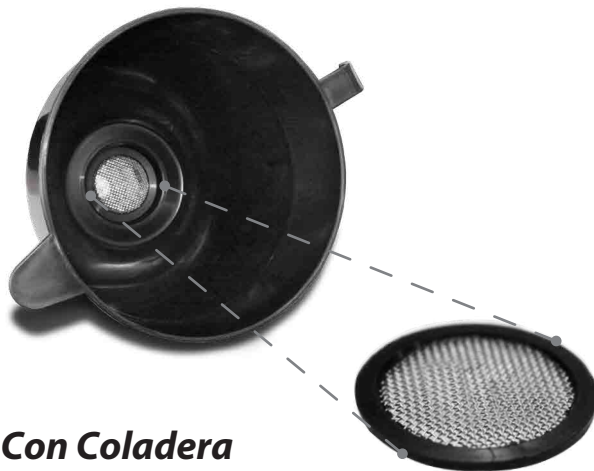

Con Coladera



**NEGRO EMB-1N
ROJO EMB-1R**



EMBUDOS PERSONALIZABLES*

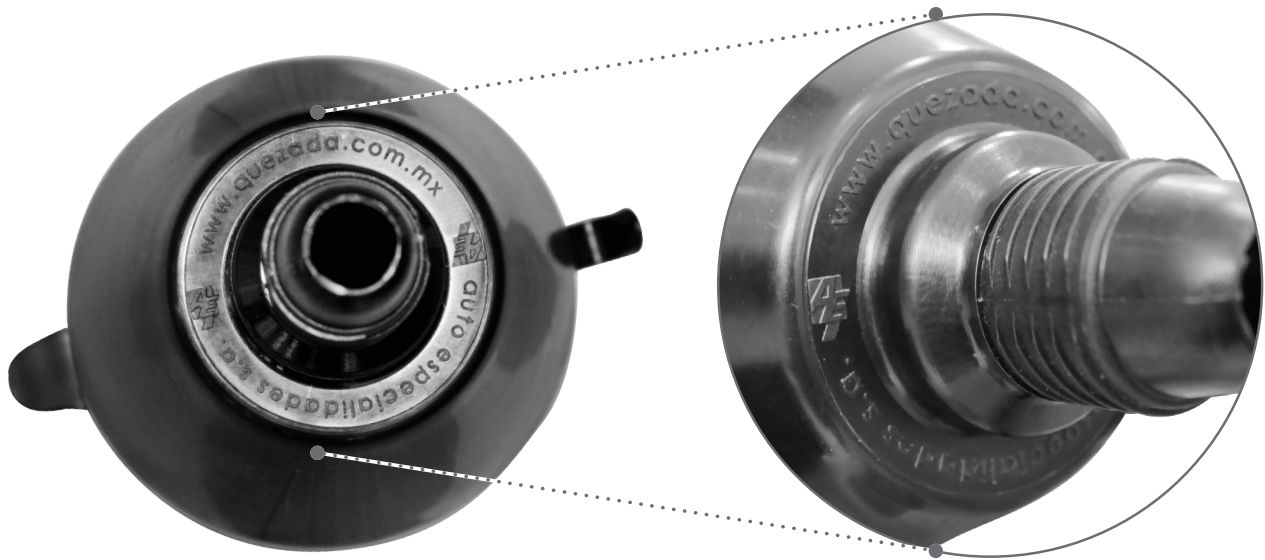

**¡CONSULTA CON NUESTROS
AGENTES Y GRABA TU MARCA!
(*1000 PIEZAS MÍNIMO)**

**¡También desarrollamos embudos personalizados,
ponte en contacto con nosotros y elige tu color!**

Verde-Anaranjado-Azul-Rojo-Negro

**Comunícate con nosotros a los Tels.: (01-55) 5353-0690, 5353-0816, 5353-0774, Fax: 5352-5333,
o envía un correo a: ventas@quezada.com.mx y con gusto te apoyaremos.**



MAQUILAS

EMBUDO DIRECCIÓN HIDRÁULICA

MAQUILAS/ EMBUDOS



EMB-1N
EMBUDO NEGRO 25cm
C/COLADERA

EMB-1R
EMBUDO ROJO 25cm
C/COLADERA



EMB-E-2
EXTENSIÓN DE PLÁSTICO P/LIQUIDO DE DIRECCIÓN
HIDRÁULICA 30cm



EMB-1N-L
EMBUDO NEGRO
CON COLADERA GUSANO
DE 50 CM PLÁSTICO



EMB-2N
EMBUDO NEGRO C/ COLADERA
Y EXTENSIÓN PARA LÍQUIDO
DE DIRECCIÓN HIDRÁULICA:
EMB-E-2



EMB-KIT

EMBUDO MULTIUSOS NEGRO CON COLADERA, EXTENSIÓN DE 25CM Y EXTENSIÓN PARA LIQUIDO DE DIRECCIÓN HIDRÁULICA DE 30CM

- 1-Extensión Diesel
- 2-Dirección Hidráulica
- 3-Aceite Motor

VOLKSWAGEN

A1	CARIBE - ATLANTIC (1977-87)
A2	GOLF - JETTA (1988 -92)
A3	GOLF - JETTA (1993 - 99)
A4	GOLF - JETTA (2000-2018)
A5	JETTA CLÁSICO (2008 - UP) - GOLF GTI (2007 - 09)
A6	GOLF - JETTA MK (2010 - UP)
NB	NEW BEETLE - BEETLE (2006-2018)
S13	DERBY(2002-2012)
T1	VOLKSWAGEN SEDAN (1965-2002)
T2	COMBI 1600 ENFRIADA POR AIRE (1970 - 87)
T2A	COMBI 1800 ENFRIADA POR AGUA (1988 -2001)
T3	CORSAR (1984-1987)
T4	EUROVAN 2.5 LTS (2000 - 2004)
T5	EUROVAN TDI 1.9 LTS (2005 - UP)
T6	EUROVAN (2015-UP)

NISSAN

720	NISSAN ESTAQUITAS MOTOR J18 (1975-82)
B11	TSURU I(1984-1987)
B12	TSURU II(1988-91)
B13	TSURU III(1992-2018)
B14	SENTRA (1996 - 2001)
B15	SENTRA (2002 - 2006)
B16	SENTRA (2007 - 2011)
D21	NISSAN ESTAQUITAS MOTOR 2.4 LTS(1992-2008)
D22	FRONTIER D22 (2009-2018)



RECOMENDACIONES DE USO

DEPÓSITO ANTICONGELANTE

RECOMENDACIONES



- 1.- Tapón
- 2.- Alimentador de Anticongelante
- 3.- Entrada para Manguera del Radiador
- 4.- Válvula de escape
- 5.- Soporte del depósito
- 6.- Punto de sujeción
- 7.- Punto de sujeción

PARA INSTALAR:

- 1- Drene el Anticongelante del motor.
- 2- Afloje los tornillos que sujetan al depósito.
- 3- Retire las mangueras que sujetan al depósito.
- 4- Permita que se vacíe el depósito en su totalidad.
- 5- Extraiga el depósito del auto.
- 6- Coloque el nuevo depósito en su lugar.
- 7- Coloque y apriete los tornillos que sujetan al depósito.
- 8- Coloque las mangueras en el depósito procurando que las abrazaderas queden apretadas para evitar fugas.
- 9- Rellene el sistema con anticongelante.
- 10- Coloque el tapón del depósito.
- 11- Purgue el sistema para evitar problemas de sobrepresión y posibles fugas de anticongelante.

Se recomienda utilizar anticongelante NUEVO y reemplazar el tapón cuando reemplace el depósito.

NUESTROS PRODUCTOS ESTÁN GARANTIZADOS CONTRA DEFECTOS DE FABRICACIÓN, EN CASO DE PRESENTARSE ALGUNA ANOMALÍA, DEVUELVA SU PRODUCTO AL PROVEEDOR EL CUAL A CAMBIO LE ENTREGARÁ UNO NUEVO. NO APLICA EN EL CASO DE MALA COLOCACIÓN, MANIOBRA INCORRECTA DEL PRODUCTO, TRATO INADECUADO, GOLPES ACCIDENTALES O ALTERACIÓN ALGUNA PARA SER REPARADO O MODIFICADO PARCIAL O TOTALMENTE. ESTA GARANTÍA NO PROCEDE SI SE OMITEN O CAMBIAN LAS INSTRUCCIONES.

RECOMENDACIONES DE USO

TOMA DE AGUA



RECOMENDACIONES

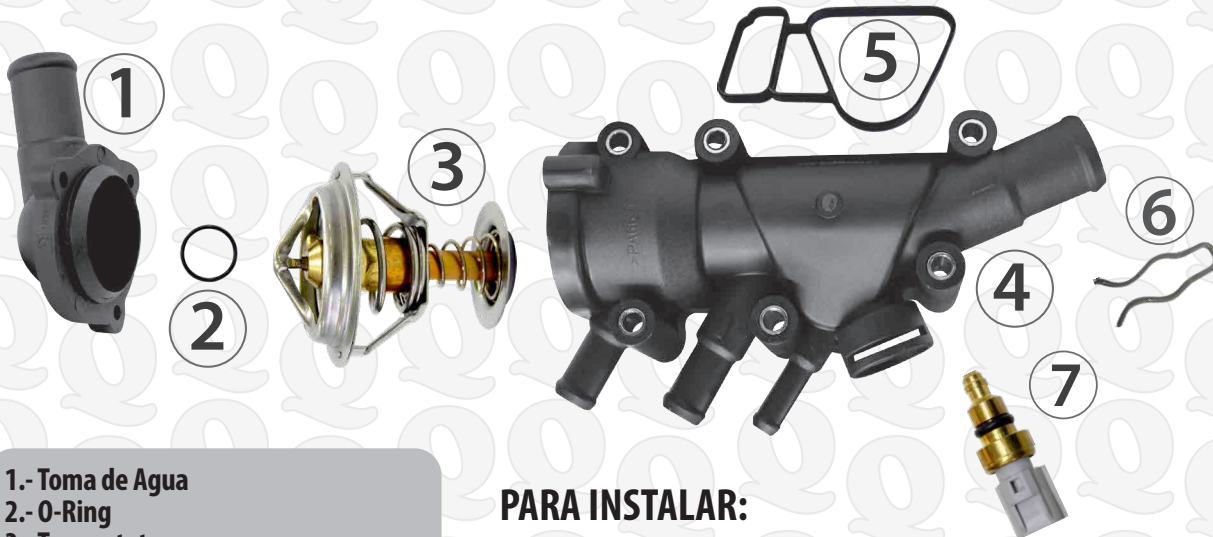

- 1.- Toma de Agua
- 2.- O-Ring
- 3.- Termostato
- 4.- Caja de termostato (Housing)
- 5.- Liga
- 6.- Seguro
- 7.- Sensor de termostato

PARA INSTALAR:

- 1- Drene el Anticongelante del motor.
- 2- Retire la manguera del radiador.
- 3- Retire la toma de agua así como el termostato.
- 4- Retire restos de la junta o sellador viejo de la superficie en la que será colocada la toma de agua.
- 5- Coloque el termostato con el purgador de aire o válvula de alivio hacia arriba.
- 6- Instale la toma de agua, coloque los tornillos y posteriormente apriete.
- 7- Coloque las mangueras procurando que las abrazaderas queden apretadas para evitar fugas.
- 8- Una vez instalado arranque el motor del vehículo durante 5 minutos para corroborar que no existan fugas.

Vista del housing armado

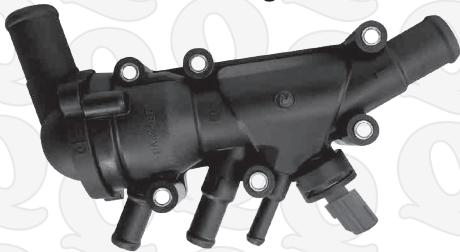

Toma de Agua

Toma de Agua con termostato

Se recomienda reemplazar el termostato cuando reemplace la toma de agua y usar una aplicación precisa de WD-40 al termostato para evitar que se pegue.

NUESTROS PRODUCTOS ESTÁN GARANTIZADOS CONTRA DEFECTOS DE FABRICACIÓN, EN CASO DE PRESENTARSE ALGUNA ANOMALÍA, DEVUELVA SU PRODUCTO AL PROVEEDOR EL CUAL A CAMBIO LE ENTREGARÁ UNO NUEVO. NO APLICA EN EL CASO DE MALA COLOCACIÓN, MANIOBRA INCORRECTA DEL PRODUCTO, TRATO INADECUADO, GOLPES ACCIDENTALES O ALTERACIÓN ALGUNA PARA SER REPARADO O MODIFICADO PARCIAL O TOTALMENTE. ESTA GARANTÍA NO PROCEDE SI SE OMITEN O CAMBIAN LAS INSTRUCCIONES.



CASOS DONDE NO PROCEDE LA GARANTÍA

DEPÓSITO ANTICONGELANTE

SOBRE LA GARANTÍA

Los productos de Compañía Industrial Quezada S.A. de C.V. pasan por un riguroso proceso de inspección de calidad, el cual finaliza al empaquetar la pieza para ser surtida. Por esta razón todos los productos que son enviados a nuestros clientes se encuentran en perfectas condiciones, tanto en forma funcional como estéticamente.

Los Depósitos Anticongelantes tienen áreas críticas, por lo cual el cliente debe tener cuidado con el manejo para evitar que éstas se dañen.

Las causas más comunes por lo cual estas piezas se rompen se deben a la maniobra incorrecta del producto y son principalmente:

- Caída del producto o golpes accidentales

Durante el traslado o demostración del producto al cliente.

- Trato inadecuado: Alteración alguna para ser reparado o modificado parcial o totalmente para ensamblarlo.

- Almacenaje inadecuado. Durante el traslado y acomodo de las piezas.

- Mala colocación. Cuando el cliente final somete o aplica fuerza o torque excesivo a la pieza provocando que se rompa.

- Utilizar líquido anticongelante. No rebajarlo o sustituirlo por agua con sales.

- Cambie el anticongelante. Para evitar el mal funcionamiento realice el cambio completo (sin rebajarlo con agua) cada 6 meses.

Depósito en buenas condiciones



Acercamiento de depósito en buenas condiciones



Depósito evidentemente, dañado por mala colocación o mal manejo

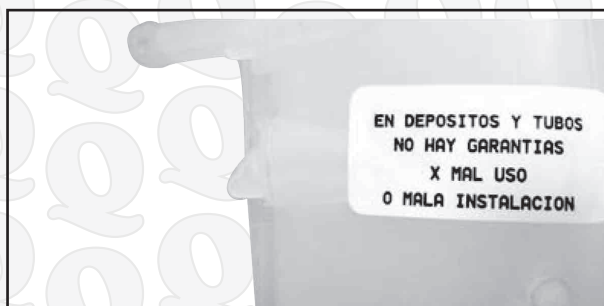

Contamos con una caja diseñada para evitar daños en los depósitos y una etiqueta informativa.

RECUERDE: NUESTROS PRODUCTOS ESTÁN GARANTIZADOS CONTRA DEFECTOS DE FABRICACIÓN, SI DETECTA UNA FALLA DE FABRICACIÓN O EN CASO DE PRESENTARSE ALGUNA ANOMALÍA, REPÓRTELO DE INMEDIATO Y DEVUELVA SU PRODUCTO AL PROVEEDOR EL CUAL A CAMBIO LE ENTREGARÁ UNO NUEVO. ESTA GARANTÍA NO PROCEDE SI SE DETECTAN LOS CASOS ARRIBA MENCIONADOS.

CASOS DONDE NO PROCEDE LA GARANTÍA

TOMA DE AGUA Y HOUSING



SOBRE LA GARANTÍA

Los productos de Compañía Industrial Quezada S.A. de C.V. pasan por un riguroso proceso de inspección de calidad, el cual finaliza al empacar la pieza para ser surtida. Por esta razón todos los productos que son enviados a nuestros clientes se encuentran en perfectas condiciones, tanto en forma funcional como estéticamente.

Los Tomas de Agua y Housings tienen áreas y superficies críticas, por lo cual el cliente debe tener cuidado con el manejo para evitar que éstas se dañen.

Las causas más comunes por lo cual estas piezas se rompen se deben a la maniobra incorrecta del producto y son principalmente:

- Caída del producto o golpes accidentales

Durante el traslado o demostración del producto al cliente.

- Trato inadecuado: Alteración alguna para ser reparado o modificado parcial o totalmente para ensamblarlo.

- Almacenaje inadecuado. Durante el traslado y acomodo de las piezas.

- Mala colocación. Cuando el cliente final somete o aplica fuerza o torque excesivo a la pieza provocando que se rompa.

- Utilizar líquido anticongelante. No rebajarlo o sustituirlo por agua con sales. El anticongelante controla la temperatura (máx. 86°) y el agua NO.

Housing en buenas condiciones



Housing evidentemente, dañado por mala colocación o mal manejo



Housing evidentemente dañado por no colocar anticongelante y usar agua o por mala colocación



Toma en buenas condiciones.

Toma dañada por mal uso.

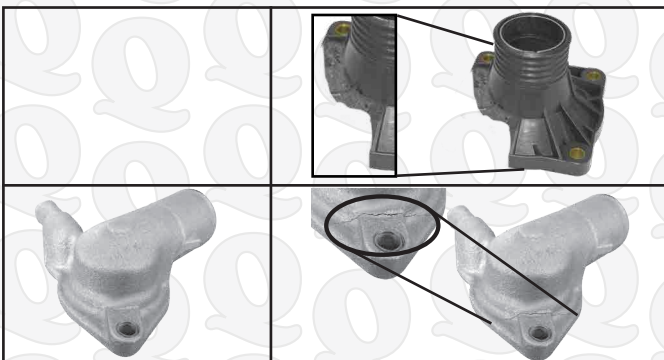

Generalmente se agrieta por colocar el termostato alrevés.

RECUERDE: NUESTROS PRODUCTOS ESTÁN GARANTIZADOS CONTRA DEFECTOS DE FABRICACIÓN, SI DETECTA UNA FALLA DE FABRICACIÓN O EN CASO DE PRESENTARSE ALGUNA ANOMALÍA, REPÓRTELO DE INMEDIATO Y DEVUELVA SU PRODUCTO AL PROVEEDOR EL CUAL A CAMBIO LE ENTREGARÁ UNO NUEVO. ESTA GARANTÍA NO PROCEDE SI SE DETECTAN LOS CASOS ARRIBA MENCIONADOS.



CASOS DONDE NO PROCEDE LA GARANTÍA

TUBO DE ENFRIAMIENTO

SOBRE LA GARANTÍA

Los productos de Compañía Industrial Quezada S.A. de C.V. pasan por un riguroso proceso de inspección de calidad, el cual finaliza al empaquetar la pieza para ser surtida. Por esta razón todos los productos que son enviados a nuestros clientes se encuentran en perfectas condiciones, tanto en forma funcional como estéticamente.

Los Tubos de Enfriamiento tienen áreas críticas, por lo cual el cliente debe tener cuidado con el manejo para evitar que éstas se dañen.

Las causas más comunes por lo cual estas piezas se rompen se deben a la maniobra incorrecta del producto y son principalmente:

- Caída del producto o golpes accidentales

Durante el traslado o demostración del producto al cliente.

- Trato inadecuado: Alteración alguna para ser reparado o modificado parcial o totalmente para ensamblarlo.

- Almacenaje inadecuado. Durante el traslado y acomodo de las piezas.

- Mala colocación. Cuando el cliente final somete o aplica fuerza o torque excesivo a la pieza provocando que se rompa.



Tubo en buenas condiciones



Acercamiento de Tubo en buenas condiciones

Tubo evidentemente, dañado por mala colocación o mal manejo

Contamos con una etiqueta informativa.

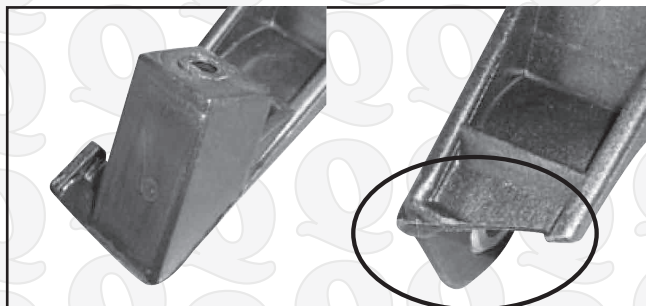

RECUERDE: NUESTROS PRODUCTOS ESTÁN GARANTIZADOS CONTRA DEFECTOS DE FABRICACIÓN, SI DETECTA UNA FALLA DE FABRICACIÓN O EN CASO DE PRESENTARSE ALGUNA ANOMALÍA, REPÓRTELO DE INMEDIATO Y DEVUELVA SU PRODUCTO AL PROVEEDOR EL CUAL A CAMBIO LE ENTREGARÁ UNO NUEVO. ESTA GARANTÍA NO PROCEDE SI SE DETECTAN LOS CASOS ARRIBA MENCIONADOS.

Ofrecemos el servicio de desarrollo de productos ó maquilas en:

°Inyección de Aluminio y Zamak (Die-Casting)

°Fundición de Aluminio:
Vaciado de arena por gravedad

°Inyección de plástico

°Desarrollo de productos en tubo y hule

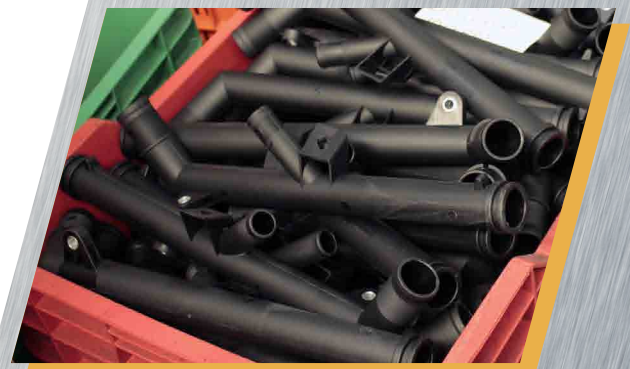

Mayores informes:

Tels. (01-55) 5353-0690, 5353-0816, 5353-0774

comercioexterno@quezada.com.mx / www.quezada.com.mx

*Compañía Industrial Quezada S. A. de C. V., San Esteban No. 47-1
Col. San Sebastián, Ciudad de México, CDMX, C.P. 02040*

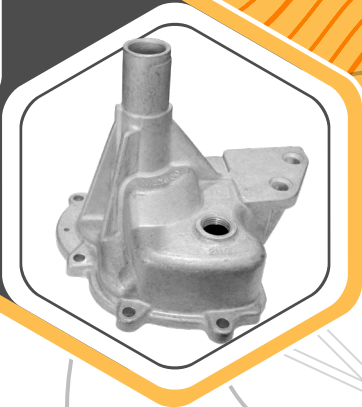

¿Encontraste la pieza que buscabas? Si aún no la manejamos ¡Podemos desarrollarla!

Comunícate a los Tels.: (01-55) 5353-0690, 5353-0816, 5353-0774
o envía un correo a: ventas@quezada.com.mx y con gusto te apoyaremos.

 www.quezada.com.mx